

**Republic of Yemen**

**Sana'a Community College**

**Higher Professional Education Project**

**Communications Engineering Department**



# **Planning and Optimization of Mobile Networks Using Forsk Atoll Software**

**(A Comparative Study of LTE and 5G NR Networks)**

Submitted by

**Safwan Dabwan**

Supervised by

**Prof. Jamil Sultan**

A Bachelor Thesis

Submitted to the Department of Communications Engineering

Sana'a Community College

In Partial Fulfillment of the Requirements for the Degree of Bachelor of  
Communications Engineering

August 2022

# QUR'ANIC VERSE

Qur'an Chapter 18 The cave سورة الكهف - Al-Kahf: Verse 66

(( قَالَ لَهُ مُوسَىٰ هَلْ أَتَّبِعُكَ عَلَىٰ أَنْ تُعَلِّمَ مِنَّمَا عَلَّمْتَ مَرشُدًا ))

Mûsâ (Moses) said to him (Khidr): "May I follow you so that you teach me something of that knowledge (guidance and true path) which you have been taught (by Allâh)?"

# AUTHOR BIO

**Safwan Ismail Ahmed Dabwan**

**safwan.eng.tcet@gmail.com**



- Bachelor degree in Telecommunications Engineering Technology.
- CCNA in Networks Engineering.
- IT Specialist.

# DEDICATION

**This thesis is dedicated to ...**

To my Parents, for their love and endless support.

To my college, Sana'a Community College, for giving us the opportunity to peruse my dreams and ambitions.

To my homeland, Yemen, for teaching us how to struggle and strive for what we believe in.

# **ACKNOWLEDGEMENT**

All thanks to the supervisor of this thesis, Dr. Jamil Sultan, for providing guidance and feedback throughout this project, and for his patience, motivation, enthusiasm, and immense knowledge.

Special gratitude goes to all those who have directly or remotely helped to get this study done.

# TABLE OF CONTENTS

QUR'ANIC VERSE .....	i
AUTHOR BIO.....	ii
ACKNOWLEDGEMENT.....	iv
TABLE OF CONTENTS .....	v
LIST OF TABLES .....	ix
LIST OF FIGURES .....	x
LIST OF ABBREVIATIONS AND ACRONYMS .....	xxi
<b>CHAPTER ONE: INTRODUCTION .....</b>	<b>1</b>
<b>1.1 Introduction .....</b>	<b>2</b>
<b>1.2 Background.....</b>	<b>2</b>
<b>1.3 Motivation.....</b>	<b>4</b>
<b>1.4 Problem Statement.....</b>	<b>4</b>
<b>1.5 Questions.....</b>	<b>5</b>
<b>1.4.1 Main question.....</b>	<b>5</b>
<b>1.4.2 Sub-questions .....</b>	<b>5</b>
<b>1.6 Objectives.....</b>	<b>5</b>
<b>1.7 Importance.....</b>	<b>6</b>
<b>1.8 Scope of Study.....</b>	<b>6</b>
<b>1.8.1 Time scope .....</b>	<b>6</b>
<b>1.8.2 Geographical scope .....</b>	<b>6</b>
<b>1.9 Structure .....</b>	<b>7</b>
<b>1.10 Key Terms.....</b>	<b>7</b>
<b>CHAPTER TWO: LITERATURE REVIEW.....</b>	<b>11</b>
<b>2.1 Introduction .....</b>	<b>11</b>
<b>2.2 Cellular Communications.....</b>	<b>11</b>

2.2.1 Definition .....	11
2.2.2 Mobile Communications Principles .....	12
2.2.3 Early Mobile Telephone System Architecture .....	12
2.2.4 Mobile Telephone System Using the Cellular Concept .....	13
2.2.5 Cellular System Architecture .....	15
2.2.6 North American Analog Cellular Systems .....	19
2.2.7 Narrowband Analog Mobile Phone Service (NAMPS) .....	21
2.2.8 Cellular System Components .....	21
2.2.9 Digital Systems .....	23
2.3 LTE .....	27
2.3.1 Introduction .....	27
2.3.2 LTE Frame Structure .....	29
2.3.3 Spatial Multiplexing .....	30
2.3.4 Transmit Diversity .....	31
2.3.5 Link Adaptation .....	31
2.3.6 Rate Matching .....	31
2.3.7 LTE deployment methodology .....	32
2.3.8 Architecture of LTE System .....	32
2.3.10 Evolved NodeB (eNB) .....	34
2.3.11 Evolved Packet Core (EPC) .....	40
2.3.12 Interfaces in LTE .....	43
2.3.13 Network Evolution towards LTE .....	43
2.4 5G NR .....	44
2.4.1 Introduction .....	44
2.4.2 Hardware .....	44
2.4.3 Software .....	45
2.4.4 Features .....	45

<b>2.4.5 5G Based on Cognitive Radio 5G Concept</b> .....	45
<b>2.4.6 Requirements</b> .....	46
<b>2.4.7 Characteristics</b> .....	47
<b>2.4.8 Applications</b> .....	47
<b>2.4.9 Architecture</b> .....	48
<b>2.4.10 Deployments Scenarios</b> .....	50
<b>2.5 Cellular Planning and Optimization</b> .....	59
<b>2.5.1 Introduction</b> .....	59
<b>2.5.2 Base Station Location</b> .....	60
<b>2.5.3 Frequency Planning</b> .....	61
<b>2.5.4 Radio Resource Management (RRM)</b> .....	62
<b>2.5.5 Capacity Analysis for Wireless Communications</b> .....	64
<b>2.5.6 In-building Solutions</b> .....	66
<b>2.6 Related Works</b> .....	67
<b>CHAPTER THREE: METHODOLOGY</b> .....	74
<b>3.1 Introduction</b> .....	75
<b>3.2 Specifications of the Design</b> .....	77
<b>3.2.1 LTE</b> .....	77
<b>3.2.2 5G NR</b> .....	85
<b>3.3 Technology Requirements</b> .....	93
<b>3.3.1 LTE</b> .....	93
<b>3.3.2 5G NR</b> .....	94
<b>3.4 Initial Settings</b> .....	97
<b>3.4.1 LTE</b> .....	98
<b>3.4.2 5G NR</b> .....	107
<b>3.5 Initial Predictions and Simulations</b> .....	113
<b>3.5.1 LTE</b> .....	113



3.5.2 5G NR .....	125
3.6 Optimization Procedure .....	136
3.6.1 LTE .....	137
3.6.2 5G NR .....	149
<b>CHAPTER FOUR: RESULTS ANALYZING AND DISCUSSION .....</b>	<b>164</b>
4.1 Introduction .....	165
4.2 Results and Discussions .....	165
4.2.1 LTE .....	165
4.2.2 5G NR .....	196
<b>CHAPTER FIVE: RESULTS, RECOMMENDATIONS AND FUTURE RESEARCH PERSPECTIVES .....</b>	<b>221</b>
5.1 Introduction .....	222
5.1 Results .....	222
5.2 Recommendations .....	223
5.3 Future Research Perspectives .....	224
<b>CHAPTER SIX: CONCLUSION .....</b>	<b>226</b>
6.1 Introduction .....	227
6.2 Conclusion.....	227
<b>REFERENCES.....</b>	<b>230</b>

# LIST OF TABLES

<b>Table 2. 1:</b> LTE Network Interfaces .....	43
<b>Table 3. 1:</b> PRACH detection effort vs. cell radius .....	80
<b>Table 3. 2:</b> Mobile technologies Frequency accuracy and cell radius .....	80
<b>Table 3. 3:</b> 5G cells specifications .....	87
<b>Table 3. 4:</b> User experience KPI's and system performance requirements .....	91
<b>Table 3. 5 :</b> LTE requirements according to (Starr et al., 2014) .....	94
<b>Table 3. 6:</b> Initial settings of transmitters in LTE design.....	98
Table 3. 7: Initial settings of cells in LTE design .....	99
<b>Table 3. 8:</b> initial settings of mobility in LTE design .....	104
<b>Table 3. 9:</b> Initial settings of Business User profile in LTE design .....	107
<b>Table 3. 10:</b> Initial settings of Standard User profile in LTE design .....	107
<b>Table 3. 11:</b> Initial settings of transmitters in 5G NR design .....	108
Table 3. 12: Initial settings of cells in 5G NR design.....	109
<b>Table 3. 13:</b> initial settings of the services available in 5G NR design .....	111
<b>Table 3. 14:</b> initial settings of mobility in 5G NR design .....	111
<b>Table 3. 15:</b> Initial settings of Business User profile in 5G NR design .....	112
<b>Table 3. 16:</b> Initial settings of Standard User profile in 5G NR design .....	113

# LIST OF FIGURES

<b>Figure 2. 1:</b> Basic Mobile Telephone Service.....	12
<b>Figure 2. 2:</b> Early Mobile Telephone System Architecture .....	13
<b>Figure 2. 3:</b> Mobile Telephone System Using a Cellular Architecture .....	14
<b>Figure 2. 4:</b> A Seven-Cell Cluster.....	16
<b>Figure 2. 5:</b> Frequency Reuse .....	17
<b>Figure 2. 6:</b> Cell Splitting .....	18
<b>Figure 2. 7:</b> Handoff between Adjacent Cells.....	19
<b>Figure 2. 8:</b> Cellular System Components .....	22
<b>Figure 2. 9:</b> Digital Cellular System .....	24
<b>Figure 2. 10:</b> Fixed Wireless Access .....	26
<b>Figure 2. 11 :</b> OFDMA and SC-FDMA.....	28
<b>Figure 2. 12:</b> Frequency-time domain representation of OFDM signal .....	28
<b>Figure 2. 13:</b> FDD & TDD.....	29
<b>Figure 2. 14:</b> Frame structure used for FDD.....	30
<b>Figure 2. 15:</b> LTE Peak User Bit Rates at 05MHz BW .....	32
<b>Figure 2. 16:</b> LTE Peak User Bit Rates at 20MHz BW .....	32
<b>Figure 2. 17:</b> LTE Architecture.....	33
<b>Figure 2. 18:</b> E-UTRAN .....	34
<b>Figure 2. 19:</b> Equipment block diagram of eNB.....	35
<b>Figure 2. 20:</b> MIMO.....	35
<b>Figure 2. 21:</b> Typical structure of LTE omniceils .....	36
<b>Figure 2. 22:</b> Typical structure of LTE 3-sector cells (each cell includes 3 x 120 degree sectors).....	37
<b>Figure 2. 23:</b> Remote Radio Head .....	37
<b>Figure 2. 24:</b> Baseband Unit .....	38
<b>Figure 2. 25:</b> eNB Antenna with RRH.....	39
<b>Figure 2. 26:</b> eNB Antenna with RRH (Actual scenario).....	39
<b>Figure 2. 27:</b> EPC interfaces .....	40
<b>Figure 2. 28:</b> Evolution of LTE .....	43
<b>Figure 2. 29:</b> 5G System Architecture .....	49
<b>Figure 2. 30:</b> The top three cases of 5G uses .....	50

<b>Figure 2. 31:</b> Option 1 .....	52
<b>Figure 2. 32:</b> High-level 5GC SA Option 2 interworks with EPC .....	53
<b>Figure 2. 33:</b> Option 2 .....	53
<b>Figure 2. 34:</b> Option 3 .....	54
<b>Figure 2. 35:</b> Option 3a .....	55
<b>Figure 2. 36:</b> Option 3x .....	55
<b>Figure 2. 37:</b> Option 4 .....	56
<b>Figure 2. 38:</b> Option 4a .....	57
<b>Figure 2. 39:</b> Option 5 .....	57
<b>Figure 2. 40:</b> Option 7 .....	58
<b>Figure 2. 41:</b> Option 7a .....	58
<b>Figure 2. 42:</b> An illustration of base station location .....	60
<b>Figure 2. 43:</b> An illustration of frequency assignment .....	61
<b>Figure 2. 44:</b> An illustration of interference .....	64
<b>Figure 2. 45:</b> Illustration of interference cancellation .....	65
<b>Figure 2. 46:</b> In-Building Distributed Antenna Systems .....	67
<b>Figure 3. 1:</b> Location of the study within 3 layers of Atoll .....	78
<b>Figure 3. 2:</b> The size of computation zone and its coordination .....	79
<b>Figure 3. 3:</b> Distribution of the 5 sites .....	81
<b>Figure 3. 4:</b> specifications of base station template of LTE technology .....	82
<b>Figure 3. 5:</b> Site radius and site-to-site formulas .....	82
<b>Figure 3. 6:</b> site-to-site distance from site 1 to site 3 .....	83
<b>Figure 3. 7:</b> site-to-site distance from site 4 to site 5 .....	84
<b>Figure 3. 8:</b> Users density value per km <sup>2</sup> .....	85
<b>Figure 3. 9:</b> Distribution of the 24 sites .....	88
<b>Figure 3. 10:</b> specifications of base station template of 5G NR technology .....	88
<b>Figure 3. 11:</b> Site radius and site-to-site formulas .....	89
<b>Figure 3. 12:</b> site-to-site distance from site 21 to site 25 .....	90
<b>Figure 3. 13:</b> site-to-site distance from site 10 to site 14 .....	90
<b>Figure 3. 14:</b> Users density value per km <sup>2</sup> in 5G micro cell .....	92
<b>Figure 3. 15:</b> service requirements setting of LTE within Atoll services table .....	94
<b>Figure 3. 16:</b> Broadband service properties window for 5G NR .....	96

<b>Figure 3. 17:</b> Voice Only properties window for 5G NR .....	97
<b>Figure 3. 18:</b> Initial settings of sites in LTE design.....	98
<b>Figure 3. 19:</b> Initial settings of high speed internet service of LTE .....	101
<b>Figure 3. 20:</b> Initial settings of mobile internet access service of LTE .....	102
<b>Figure 3. 21:</b> Initial settings of video conferencing service of LTE .....	103
Figure 3. 22: Initial settings of voice only service of LTE .....	104
<b>Figure 3. 23:</b> Initial settings of MIMO terminal in LTE design .....	105
<b>Figure 3. 24:</b> Initial settings of mobile terminal in LTE design .....	106
Figure 3. 25 .....	107
<b>Figure 3. 26:</b> Initial settings of sites in 5G NR design.....	108
<b>Figure 3. 27:</b> Initial settings of 5G Smartphone terminal in 5G NR design .....	112
<b>Figure 3. 28:</b> prediction result of Coverage by Transmitter (DL) in LTE technology .....	113
<b>Figure 3. 29:</b> prediction result of Coverage by Signal Level (DL) in LTE technology .....	114
<b>Figure 3. 30:</b> prediction histogram of Coverage by Signal Level (DL) in LTE technology.....	114
<b>Figure 3. 31:</b> prediction result of Overlapping Zones (DL) in LTE technology .....	115
<b>Figure 3. 32:</b> prediction histogram of Overlapping Zones (DL) in LTE technology	115
<b>Figure 3. 33:</b> prediction result of Effective Signal Analysis (DL) in LTE technology .....	116
<b>Figure 3. 34:</b> prediction histogram of Effective Signal Analysis (DL) in LTE technology.....	116
<b>Figure 3. 35:</b> prediction result of Effective Signal Analysis (UL) in LTE technology .....	117
<b>Figure 3. 36:</b> prediction histogram of Effective Signal Analysis (UL) in LTE technology.....	117
<b>Figure 3. 37:</b> prediction result of Coverage by C/(I+N) Level (DL) in LTE technology .....	118
<b>Figure 3. 38:</b> prediction histogram of Coverage by C/(I+N) Level (DL) in LTE technology.....	118
<b>Figure 3. 39:</b> prediction result of Coverage by C/(I+N) Level (UL) in LTE technology .....	119

<b>Figure 3. 40:</b> prediction histogram of Coverage by Coverage by C/(I+N) Level (UL) in LTE technology .....	119
<b>Figure 3. 41:</b> prediction result of Effective Service Area Analysis (DL+UL) in LTE technology.....	120
<b>Figure 3. 42:</b> prediction result of Coverage by Coverage by Throughput (DL) in LTE technology.....	120
<b>Figure 3. 43:</b> prediction histogram of Coverage by Throughput (DL) in LTE technology.....	121
<b>Figure 3. 44:</b> prediction result of Coverage by Throughput (UL) in LTE technology .....	121
<b>Figure 3. 45:</b> prediction histogram of Coverage by Throughput (UL) in LTE technology.....	122
<b>Figure 3. 46:</b> prediction result of Coverage by Quality Indicator (DL) in LTE technology.....	122
<b>Figure 3. 47:</b> prediction histogram of Coverage by Quality Indicator (DL) in LTE technology.....	123
<b>Figure 3. 48:</b> prediction result of Coverage by Quality Indicator (UL) in LTE technology.....	123
<b>Figure 3. 49:</b> prediction histogram of Coverage by Quality Indicator (UL) in LTE technology.....	124
<b>Figure 3. 50:</b> prediction result of Cell Identifier Collision Zones (DL) in LTE technology.....	124
<b>Figure 3. 51:</b> Initial Simulation Demands and Results of LTE technology.....	125
<b>Figure 3. 52:</b> prediction result of Coverage by Transmitter (DL) in 5G NR technology .....	126
<b>Figure 3. 53:</b> 5G NR: Downlink Coverage in 5G NR design .....	126
<b>Figure 3. 54:</b> prediction result of 5G NR: Downlink Quality in 5G NR technology	127
<b>Figure 3. 55:</b> prediction histogram of 5G NR: Downlink Quality in 5G NR technology .....	127
<b>Figure 3. 56:</b> prediction result of 5G NR: Downlink Service Areas in 5G NR technology.....	128
<b>Figure 3. 57:</b> prediction histogram of 5G NR: Downlink Service Areas in 5G NR technology.....	128

<b>Figure 3. 58:</b> prediction result of 5G NR: Downlink Capacity in 5G NR technology	129
<b>Figure 3. 59:</b> prediction histogram of 5G NR: Downlink Capacity in 5G NR technology	129
<b>Figure 3. 60:</b> prediction result of 5G NR: Uplink Coverage in 5G NR technology .	130
<b>Figure 3. 61:</b> prediction histogram of 5G NR: Uplink Coverage in 5G NR technology	130
<b>Figure 3. 62:</b> prediction result of 5G NR: Uplink Quality in 5G NR technology ....	131
<b>Figure 3. 63:</b> prediction histogram of 5G NR: Uplink Quality in 5G NR technology	131
<b>Figure 3. 64:</b> prediction result of 5G NR: Uplink Service Areas in 5G NR technology	132
<b>Figure 3. 65:</b> prediction histogram of 5G NR: Uplink Service Areas in 5G NR technology.....	132
<b>Figure 3. 66:</b> prediction result of 5G NR: Uplink Capacity in 5G NR technology ..	133
<b>Figure 3. 67:</b> prediction histogram of 5G NR: Uplink Capacity in 5G NR technology	133
<b>Figure 3. 68:</b> prediction result of Effective Service Area Analysis (DL+UL) in 5G NR technology.....	134
<b>Figure 3. 69:</b> prediction result of Coverage by Throughput (DL) in 5G NR technology	135
<b>Figure 3. 70:</b> prediction histogram of Coverage by Throughput (DL) in 5G NR technology.....	135
<b>Figure 3. 71:</b> Initial Simulation Demands and Results of 5G NR technology.....	136
<b>Figure 3. 72:</b> Setting the transmitter height to 40m in LTE design .....	137
<b>Figure 3. 73:</b> Simulation results after increasing transmitter height to 40m.....	138
<b>Figure 3. 74:</b> setting the antenna type of the transmitter .....	139
<b>Figure 3. 75:</b> Simulation results after changing the type of antenna .....	140
<b>Figure 3. 76:</b> setting new values of max power .....	141
<b>Figure 3. 77:</b> Simulation results after increasing max power of cells.....	142
<b>Figure 3. 78:</b> Modified settings of MIMO terminal in the LTE design .....	143
<b>Figure 3. 79:</b> Modified settings of Mobile terminal in the LTE design.....	144
<b>Figure 3. 80:</b> Simulation results after the modifications of UE terminals .....	145

<b>Figure 3. 81:</b> Modified settings of Azimuth Angle and Mechanical Down-tilt of Transmitters .....	146
Figure 3. 82: the studied area with the signal level prediction results after the modification of azimuth angle and mechanical down-tilt of transmitters .....	146
<b>Figure 3. 83:</b> Simulation results after the modifications of azimuth angle and mechanical down-tilt of transmitters in LTE design.....	147
<b>Figure 3. 84:</b> Modified settings of Frequency Band and the number of co-scheduled MU-MIMO .....	148
<b>Figure 3. 85:</b> Simulation results after the modifications Frequency Band and the number of co-scheduled MU-MIMO in LTE design.....	149
<b>Figure 3. 86:</b> Setting the transmitter height to 20m in 5G NR design .....	150
<b>Figure 3. 87:</b> Simulation results after decreasing transmitter height to 20m.....	151
<b>Figure 3. 88:</b> setting the antenna type of the transmitter .....	152
<b>Figure 3. 89:</b> Simulation results after changing the type of antenna .....	153
<b>Figure 3. 90:</b> Frequency bands window.....	154
<b>Figure 3. 91:</b> Modified settings of frequency band column within cells table .....	155
<b>Figure 3. 92:</b> Simulation results after modifying settings of frequency band.....	156
<b>Figure 3. 93:</b> Modified settings of MIMO terminal in the 5G NR design.....	157
<b>Figure 3. 94:</b> Modified settings of Mobile terminal in the 5G NR design.....	158
<b>Figure 3. 95:</b> Simulation results after the modifications of UE terminals .....	159
<b>Figure 3. 96:</b> Modified settings of Azimuth Angle and Mechanical Down-tilt of Transmitters .....	160
Figure 3. 97: the studied area with the signal level prediction results after the modification of azimuth angle and mechanical down-tilt of transmitters .....	160
<b>Figure 3. 98:</b> Simulation results after the modifications of azimuth angle and mechanical down-tilt of transmitters in 5G NR design .....	161
<b>Figure 3. 99:</b> Modified settings of Frequency Band and the number of co-scheduled MU-MIMO .....	162
<b>Figure 3. 100:</b> Simulation results after the modifications Frequency Band and the number of co-scheduled MU-MIMO in 5G NR design.....	162
<b>Figure 4. 1:</b> prediction result of Coverage by Transmitter (DL) in LTE technology (Before optimization).....	166



<b>Figure 4. 2:</b> prediction result of Coverage by Transmitter (DL) in LTE technology (After optimization) .....	166
<b>Figure 4. 3:</b> prediction result of Coverage by Signal Level (DL) in LTE technology (Before optimization).....	167
<b>Figure 4. 4:</b> prediction result of Coverage by Signal Level (DL) in LTE technology (After optimization) .....	167
<b>Figure 4. 5:</b> prediction histogram of Coverage by Signal Level (DL) in LTE technology (Before optimization).....	168
<b>Figure 4. 6:</b> prediction histogram of Coverage by Signal Level (DL) in LTE technology (After optimization) .....	168
<b>Figure 4. 7:</b> prediction histogram of Coverage by Signal Level (DL) in LTE technology (Before optimization).....	169
<b>Figure 4. 8:</b> prediction result of Overlapping Zones (DL) in LTE technology (After optimization).....	170
<b>Figure 4. 9:</b> prediction histogram of Overlapping Zones (DL) in LTE technology (Before optimization).....	170
<b>Figure 4. 10:</b> prediction histogram of Overlapping Zones (DL) in LTE technology (After optimization) .....	171
<b>Figure 4. 11:</b> prediction result of Effective Signal Analysis (DL) in LTE technology (Before optimization).....	172
<b>Figure 4. 12:</b> prediction result of Effective Signal Analysis (DL) in LTE technology (After optimization) .....	172
<b>Figure 4. 13:</b> prediction histogram of Effective Signal Analysis (DL) in LTE technology (Before optimization).....	173
<b>Figure 4. 14:</b> prediction histogram of Effective Signal Analysis (DL) in LTE technology (After optimization) .....	173
<b>Figure 4. 15:</b> prediction result of Effective Signal Analysis (UL) in LTE technology (Before optimization).....	174
<b>Figure 4. 16:</b> prediction result of Effective Signal Analysis (UL) in LTE technology (After optimization) .....	175
<b>Figure 4. 17:</b> prediction histogram of Effective Signal Analysis (UL) in LTE technology (Before optimization).....	175
<b>Figure 4. 18:</b> prediction histogram of Effective Signal Analysis (UL) in LTE technology (After optimization) .....	176

<b>Figure 4. 19:</b> prediction result of Coverage by C/(I+N) Level (DL) in LTE technology (Before optimization).....	177
<b>Figure 4. 20:</b> prediction result of Coverage by C/(I+N) Level (DL) in LTE technology (After optimization) .....	177
<b>Figure 4. 21:</b> prediction histogram of Coverage by C/(I+N) Level (DL) in LTE technology (Before optimization).....	178
<b>Figure 4. 22:</b> prediction histogram of Coverage by C/(I+N) Level (DL) in LTE technology (After optimization) .....	178
<b>Figure 4. 23:</b> prediction result of Coverage by C/(I+N) Level (UL) in LTE technology (Before optimization).....	179
<b>Figure 4. 24:</b> prediction result of Coverage by C/(I+N) Level (UL) in LTE technology (After optimization) .....	180
<b>Figure 4. 25:</b> prediction histogram of Coverage by Coverage by C/(I+N) Level (UL) in LTE technology (Before optimization).....	180
<b>Figure 4. 26:</b> prediction histogram of Coverage by Coverage by C/(I+N) Level (UL) in LTE technology (After optimization) .....	181
<b>Figure 4. 27:</b> prediction result of Effective Service Area Analysis (DL+UL) in LTE technology (Before optimization).....	182
<b>Figure 4. 28:</b> prediction result of Effective Service Area Analysis (DL+UL) in LTE technology (After optimization) .....	182
<b>Figure 4. 29:</b> prediction result of Coverage by Coverage by Throughput (DL) in LTE technology (Before optimization).....	183
<b>Figure 4. 30:</b> prediction result of Coverage by Coverage by Throughput (DL) in LTE technology (After optimization) .....	184
<b>Figure 4. 31:</b> prediction histogram of Coverage by Throughput (DL) in LTE technology (Before optimization).....	184
<b>Figure 4. 32:</b> prediction histogram of Coverage by Throughput (DL) in LTE technology (After optimization) .....	185
<b>Figure 4. 33:</b> prediction result of Coverage by Throughput (UL) in LTE technology (Before optimization).....	186
<b>Figure 4. 34:</b> prediction result of Coverage by Throughput (UL) in LTE technology (After optimization) .....	186
<b>Figure 4. 35:</b> prediction histogram of Coverage by Throughput (UL) in LTE technology (Before optimization).....	187

<b>Figure 4. 36:</b> prediction histogram of Coverage by Throughput (UL) in LTE technology (After optimization) .....	187
<b>Figure 4. 37:</b> prediction result of Coverage by Quality Indicator (DL) in LTE technology (Before optimization) .....	188
<b>Figure 4. 38:</b> prediction result of Coverage by Quality Indicator (DL) in LTE technology (After optimization) .....	189
<b>Figure 4. 39:</b> prediction histogram of Coverage by Quality Indicator (DL) in LTE technology (Before optimization) .....	189
<b>Figure 4. 40:</b> prediction histogram of Coverage by Quality Indicator (DL) in LTE technology (After optimization) .....	190
<b>Figure 4. 41:</b> prediction result of Coverage by Quality Indicator (UL) in LTE technology (Before optimization) .....	191
<b>Figure 4. 42:</b> prediction result of Coverage by Quality Indicator (UL) in LTE technology (After optimization) .....	191
<b>Figure 4. 43:</b> prediction histogram of Coverage by Quality Indicator (UL) in LTE technology (Before optimization) .....	192
<b>Figure 4. 44:</b> prediction histogram of Coverage by Quality Indicator (UL) in LTE technology (After optimization) .....	192
<b>Figure 4. 45:</b> prediction result of Cell Identifier Collision Zones (DL) in LTE technology (Before optimization) .....	193
<b>Figure 4. 46:</b> prediction result of Cell Identifier Collision Zones (DL) in LTE technology (After optimization) .....	194
<b>Figure 4. 47:</b> Initial Simulation Demands and Results of LTE technology.....	195
<b>Figure 4. 48:</b> prediction result of Coverage by Transmitter (DL) in 5G NR technology (Before optimization).....	196
<b>Figure 4. 49:</b> prediction result of Coverage by Transmitter (DL) in 5G NR technology (After optimization) .....	196
<b>Figure 4. 50:</b> 5G NR: Downlink Coverage in 5G NR design (Before optimization)	197
<b>Figure 4. 51:</b> 5G NR: Downlink Coverage in 5G NR design (After optimization)..	197
<b>Figure 4. 52:</b> prediction result of 5G NR: Downlink Quality in 5G NR technology (Before optimization).....	198
<b>Figure 4. 53:</b> prediction result of 5G NR: Downlink Quality in 5G NR technology (After optimization) .....	199

<b>Figure 4. 54:</b> prediction histogram of 5G NR: Downlink Quality in 5G NR technology (Before optimization).....	199
<b>Figure 4. 55:</b> prediction histogram of 5G NR: Downlink Quality in 5G NR technology (After optimization) .....	200
<b>Figure 4. 56:</b> prediction result of 5G NR: Downlink Service Areas in 5G NR technology (Before optimization).....	201
<b>Figure 4. 57:</b> prediction result of 5G NR: Downlink Service Areas in 5G NR technology (After optimization) .....	201
<b>Figure 4. 58:</b> prediction histogram of 5G NR: Downlink Service Areas in 5G NR technology (Before optimization).....	202
<b>Figure 4. 59:</b> prediction histogram of 5G NR: Downlink Service Areas in 5G NR technology (After optimization) .....	202
<b>Figure 4. 60:</b> prediction result of 5G NR: Downlink Capacity in 5G NR technology (Before optimization).....	203
<b>Figure 4. 61:</b> prediction result of 5G NR: Downlink Capacity in 5G NR technology (After optimization) .....	204
<b>Figure 4. 62:</b> prediction histogram of 5G NR: Downlink Capacity in 5G NR technology (Before optimization).....	204
<b>Figure 4. 63:</b> prediction histogram of 5G NR: Downlink Capacity in 5G NR technology (After optimization) .....	205
<b>Figure 4. 64:</b> prediction result of 5G NR: Uplink Coverage in 5G NR technology (Before optimization).....	206
<b>Figure 4. 65:</b> prediction result of 5G NR: Uplink Coverage in 5G NR technology (After optimization).....	206
<b>Figure 4. 66:</b> prediction histogram of 5G NR: Uplink Coverage in 5G NR technology (Before optimization).....	207
<b>Figure 4. 67:</b> prediction histogram of 5G NR: Uplink Coverage in 5G NR technology (After optimization) .....	207
<b>Figure 4. 68:</b> prediction result of 5G NR: Uplink Quality in 5G NR technology (Before optimization).....	208
<b>Figure 4. 69:</b> prediction result of 5G NR: Uplink Quality in 5G NR technology (After optimization).....	209
<b>Figure 4. 70:</b> prediction histogram of 5G NR: Uplink Quality in 5G NR technology (Before optimization).....	209

<b>Figure 4. 71:</b> prediction histogram of 5G NR: Uplink Quality in 5G NR technology (After optimization) .....	210
<b>Figure 4. 72:</b> prediction result of 5G NR: Uplink Service Areas in 5G NR technology (Before optimization).....	211
<b>Figure 4. 73:</b> prediction result of 5G NR: Uplink Service Areas in 5G NR technology (After optimization) .....	211
<b>Figure 4. 74:</b> prediction histogram of 5G NR: Uplink Service Areas in 5G NR technology (Before optimization) .....	212
<b>Figure 4. 75:</b> prediction histogram of 5G NR: Uplink Service Areas in 5G NR technology (After optimization) .....	212
<b>Figure 4. 76:</b> prediction result of 5G NR: Uplink Capacity in 5G NR technology (Before optimization).....	213
<b>Figure 4. 77:</b> prediction result of 5G NR: Uplink Capacity in 5G NR technology (After optimization).....	214
<b>Figure 4. 78:</b> prediction histogram of 5G NR: Uplink Capacity in 5G NR technology (Before optimization).....	214
<b>Figure 4. 79:</b> prediction histogram of 5G NR: Uplink Capacity in 5G NR technology (After optimization) .....	215
<b>Figure 4. 80:</b> prediction result of Effective Service Area Analysis (DL+UL) in 5G NR technology (Before optimization) .....	216
<b>Figure 4. 81:</b> prediction result of Effective Service Area Analysis (DL+UL) in 5G NR technology (After optimization) .....	216
<b>Figure 4. 82:</b> prediction result of Coverage by Throughput (DL) in 5G NR technology (Before optimization).....	217
<b>Figure 4. 83:</b> prediction result of Coverage by Throughput (DL) in 5G NR technology (After optimization) .....	217
<b>Figure 4. 84:</b> prediction histogram of Coverage by Throughput (DL) in 5G NR technology (Before optimization) .....	218
<b>Figure 4. 85:</b> prediction histogram of Coverage by Throughput (DL) in 5G NR technology (After optimization) .....	218
<b>Figure 4. 86:</b> Initial Simulation Demands and Results of 5G NR technology.....	219

# LIST OF ABBREVIATIONS AND ACRONYMS

<b>3GPP</b>	3rd Generation Partnership Project
<b>5G</b>	Fifth Generation
<b>ARFCN</b>	Absolute Radio-Frequency Channel Number
<b>BCCH</b>	Broadcast Control Channel
<b>BCH</b>	Broadcast Channel
<b>BPSK</b>	Binary Phase Shift Keying
<b>CDMA</b>	Code Division Multiple Access
<b>CINR</b>	Carrier to Interference and Noise Ratio
<b>CP</b>	Cyclic Prefix
<b>CSI-RS</b>	Channel State Information Reference Signal
<b>DL</b>	Downlink
<b>DM-RS</b>	Demodulation Reference Signal
<b>DTM</b>	Digital Terrain Model
<b>eMBB</b>	Enhanced Mobile Broadband
<b>EPRE</b>	Energy Per Resource Element
<b>FDD</b>	Frequency Division Duplex
<b>GSM</b>	Global System for Mobile communications
<b>IMT-2020</b>	International Mobile Telecommunications 2020
<b>ITU</b>	International Telecommunications Union
<b>ITU-R</b>	International Telecommunications Union-Radio Communications Sector
<b>LTE</b>	Long-Term Evolution
<b>MAC</b>	Medium Access Control
<b>MIMO</b>	Multiple-Input Multiple-Output
<b>mMTC</b>	Massive Machine Type Communication
<b>MU-MIMO</b>	Multi-User MIMO
<b>NB-IoT</b>	Narrow-Band Internet-of-Things
<b>NR</b>	New Radio
<b>OFDM</b>	Orthogonal Frequency-Division Multiplexing
<b>PBCH</b>	Physical Broadcast Channel
<b>PBCH</b>	Physical Broadcast Channel
<b>PCCH</b>	Paging Control Channel

<b>PDCCH</b>	Physical Downlink Control Channel
<b>PDCP</b>	Packet Data Convergence Protocol
<b>PDSCH</b>	Physical Downlink Shared Channel
<b>PHY</b>	Physical Layer
<b>PRACH</b>	Physical Random Access Channel
<b>PRACH</b>	Physical Random-Access Channel
<b>PSS</b>	Primary Synchronization Signal
<b>PT-RS</b>	Phase Tracking Reference Signal
<b>PUCCH</b>	Physical Uplink Control Channel
<b>PUSCH</b>	Physical Uplink Shared Channel
<b>QAM</b>	Quadrature Amplitude Modulation
<b>QPSK</b>	Quadrature Phase Shift Keying
<b>RB</b>	Resource Block
<b>RLC</b>	Radio Link Control

# **CHAPTER ONE**

# **INTRODUCTION**



# CHAPTER ONE

## INTRODUCTION

### 1.1 Introduction

The first chapter presents the general framework of the study including; the introduction, the motivation, the problem statement, the importance, the scope, the structure and the key terms of the study.

### 1.2 Background

Telecommunications engineering field is a field of non-stopping advancements especially in term of cellular communications. These advancements appear as a result of the new requirements that urge for a next generation technology every time. starting from the voice-only systems to today's intelligent communication systems. At each stage there were new requirements that could not be achieved using the current technology available back then. This led to an enormous effort looking for advanced technologies that can match the expectations of the users. Since the beginning of the last decade of 2010s until the current year of 2022, there were two theologies developed in a rapid pace. These technologies are LTE and 5G NR with many releases of them. They made an enormous change in telecommunications field in term of performance and supported applications.

Long Term Evolution also known as LTE was developed by the 3rd Generation Partnership Project (3GPP), collaboration between groups of telecommunication associations. It was released in the 4th quarter of 2008.

The 3GPP partner from the US is the Alliance for Telecommunications Industry Solutions which members include telecommunication companies, such as AT&T, Cisco and Verizon. The LTE standard is officially known as “document 3GPP Release 8”. LTE Release 8 is sometimes also called as 3.9G because it almost achieves full compliance with IMT-Advanced (Kazi, 2013).

The 5G network evolution is well underway, and it has progressed swiftly since the 3GPP standardized the first 5G NR (New Radio) release (release 15) in mid-2018. The leading mobile network operators (MNOs) in several regions of the world have already launched the first commercial 5G NR networks with mid-bands (i.e., 3–6 GHz) with the existing 4G cell sites, resulting in a significant performance boost (Dahlman et al., 2018).

Cellular planning and optimization of mobile heterogeneous networks has been a topic of study for several decades with a diversity of resources, such as analytical formulations and simulation software being employed to characterize different scenarios with the aim of improving system capacity. Furthermore, the world has now witnessed the birth of the first commercial 5G New Radio networks with a technology that was developed to ensure the delivery of much higher data rates with comparably lower levels of latency. In the challenging scenarios of 4G and beyond, Carrier Aggregation has been proposed as a resource to allow enhancements in coverage and capacity. Another key element to ensure the success of 4G and 5G networks is the deployment of Small Cells to offload Macro cells (Ramos, 2019).

According to the above mentioned points, there was a need for this bachelor thesis. This thesis studies LTE and 5G NR technologies, and the planning and optimization processes related to them. This study is done in a comparative style between the two technologies. The comparison is done through realistic simulations using Forsk Atoll software. The study aims to

achieve the optimum performance in both technologies within the same geographical parameters.

### **1.3 Motivation**

The need of higher data rates which were not provided in the 3<sup>rd</sup> generation of cellular communications technologies has led to the releases of LTE technology. This did not last for a long time, and there was a need of increasing the user density and decreasing the latency time, and all this was caused mainly by to advancement of other technologies in other fields that depend on cellular communications technologies.

Since it is difficult to deploy 5G NR at everywhere, telecom companies became interested in understanding and developing practical approaches to plan and optimize LTE and 5G NR Networks. In addition, these companies are interested in comparing the deployment process of both technologies within similar geographical areas in order to understand the similarities and differences of many aspects, so that they can review best options to make good decisions based on this kind of studies, and this was the main motivation of the current study.

### **1.4 Problem Statement**

The 3<sup>rd</sup> generation of cellular communications technologies was considered as a real revolution by the time it was first introduced in, but as years pass and the technology of different fields advance, an urgent need for a better technology started rising to the surface. The release of LTE with higher rates of data was a major enhancement that users experienced. This enhancement allowed users to get services such as video conferencing and other real-time applications that were really useful.

A few years later, there was an advancement in the field of IoT (Internet of Things), and even though LTE releases like LTE-A and LTE-Advanced Pro improved the quality of service in term of high data rates, there was a need

for a very low level of latency and a very high level of users density, and the reason behind this is that the expanded use of IoT will increase the number of connected devices, and the low latency is required since IoT is being used in medical and industrial fields that require high accuracy which requires low latency. According the previously mentioned points, there is a real need for understanding and developing practical methods for planning and optimizing LTE and 5G NR networks, and since different areas require different technologies, there was a need for a comparative study that shows the similarities and differences between the tow technologies in term of several aspects.

## **1.5 Questions**

### **1.4.1 Main question**

- What are the main differences between LTE and 5G NR technologies?

### **1.4.2 Sub-questions**

- What are the main factors that affect the planning and optimization process of each technology?
- What are the main parameters that must be different in each technology?
- What are the best options available to achieve the optimum performance level of the network in each technology?

## **1.6 Objectives**

- To investigate different settings and parameters that should be done in each technology.
- To conduct different simulations in different scenarios similar to practical environment and scenarios.

- To find the best options that can be used to achieve the optimum performance level of the network in each technology.
- To draw a general guideline for future works based on realistic simulation results.
- To clarify the pros and cons of deploying each technology which can be helpful for telecom companies to review their options and decisions.

## **1.7 Importance**

The significance of the current study comes from its nature that aims to present an inclusive vision of planning and optimizing the performance of LTE and 5G NR networks. Especially in time of rapid upgrading style that is followed by telecommunications companies in many countries. These companies are interested in understanding and applying effective deployment approaches that provide optimum level of performance while keeping an eye on a relatively good costs in order to achieve a balance of costs and quality of service.

## **1.8 Scope of Study**

### **1.8.1 Time scope**

The time scope of the current study was limited within the period from January 14, 2022 to August 4, 2022.

### **1.8.2 Geographical scope**

The geographical scope of the study was limited to an area located in the province of Sana'a, Yemen. This area is in the northern part of Sana'a province. It is basically the area where Sana'a Community College is located, and it is expanded to in all directions to cover a larger area surrounding the college. This college is where the researchers of this study have studied for their bachelor degree.

### 1.8.3 Subject Scope

The subjective scope of the study was limited to the topic of "Planning and Optimization of Mobile Networks Using Forsk Atoll Software (A Comparative Study of LTE and 5G NR Networks)".

## 1.9 Structure

The current study is divided into 6 chapters;

- Chapter One: Introduction
- Chapter Two: Literature Review and Related Works
- Chapter Three: Methodology
- Chapter Four: Results and Discussion
- Results, Recommendations and Future Research Perspectives
- Chapter Six: Conclusion

## 1.10 Key Terms

- **Network Planning:** is a process that consists of several activities whose final target is to define an optimal cost-effective network design, which is then built as a mobile cellular network.
- **Network Optimization:** is a process that occurs during network implementation to prepare the network for the launch. The aim is to ensure that the agreed objectives for coverage, quality and service performance are met.

- **LTE (Long-Term Evolution):** is a fourth-generation (4G) wireless standard that provides increased network capacity and speed for cellphones and other cellular devices compared with third-generation (3G) technology.
  
- **5G New Radio (NR):** is the global standard for a unified, more capable 5G wireless air interface. It will deliver significantly faster and more responsive mobile broadband experiences, and extend mobile technology to connect and redefine a multitude of new industries.
  
- **Forsk Atoll:** is a multi-technology wireless network design and optimization software that allows operators to streamline planning and optimization activities by combining predictions and live network data.





# **CHAPTER 2**

## **LITERATURE REVIEW**

# CHAPTER TWO

## LITERATURE REVIEW

### 2.1 Introduction

This chapter presents the literature review and related works. The literature review includes; the concept of cellular communications and its aspects, LTE technology and its aspects, 5G NR technology and its aspects and the concept of cellular planning and optimization. In addition, it presents an overview of a number of related works.

### 2.2 Cellular Communications

#### 2.2.1 Definition

A cellular mobile communications system uses a large number of low-power wireless transmitters to create cells—the basic geographic service area of a wireless communications system. Variable power levels allow cells to be sized according to the subscriber density and demand within a particular region. As mobile users travel from cell to cell, their conversations are "handed off" between cells in order to maintain seamless service. Channels (frequencies) used in one cell can be reused in another cell some distance away. Cells can be added to accommodate growth, creating new cells in unserved areas or overlaying cells in existing areas (Reed, 2014).

## 2.2.2 Mobile Communications Principles

Each mobile uses a separate, temporary radio channel to talk to the cell site. The cell site talks to many mobiles at once, using one channel per mobile. Channels use a pair of frequencies for communication—one frequency, the forward link, for transmitting from the cell site, and one frequency, the reverse link, for the cell site to receive calls from the users. Radio energy dissipates over distance, so mobiles must stay near the base station to maintain communications. The basic structure of mobile networks include telephone systems and radio services. Where mobile radio service operates in a closed network and has no access to the telephone system, mobile telephone service allows interconnection to the telephone network (see Figure 2. 1) (Reed, 2014).

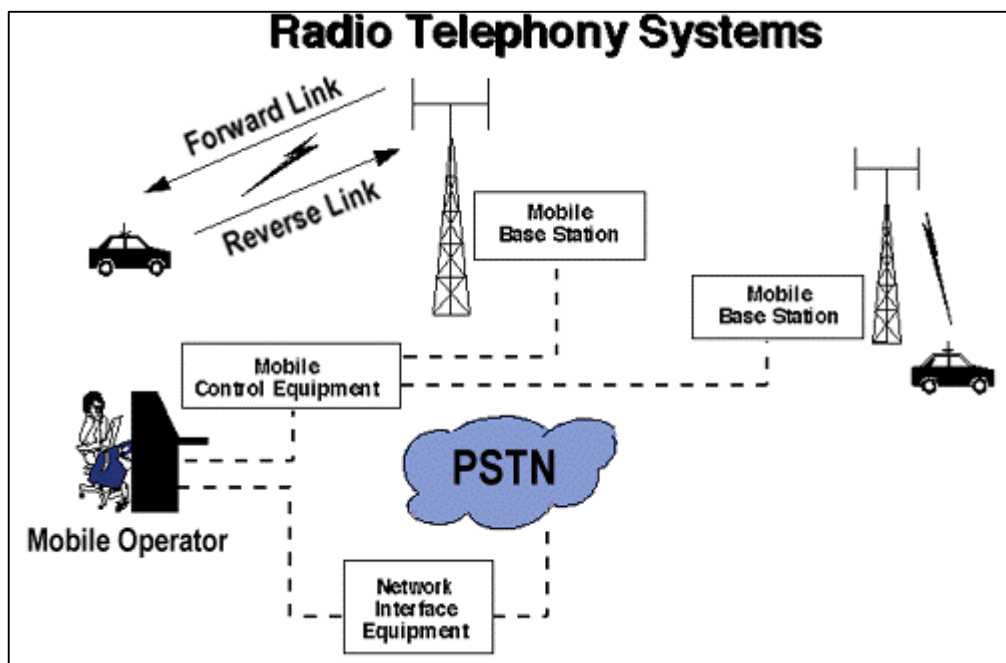
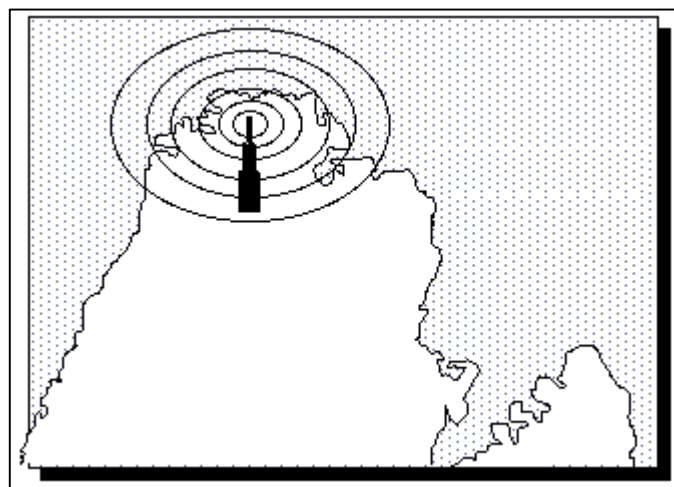


Figure 2. 1: Basic Mobile Telephone Service

## 2.2.3 Early Mobile Telephone System Architecture

Traditional mobile service was structured similar to television broadcasting: One very powerful transmitter located at the highest spot in an area would broadcast in a radius of up to fifty kilometers. The cellular concept" structured the mobile telephone network in a different way. Instead of using

one powerful transmitter, many low-power transmitters were placed throughout a coverage area. For example, by dividing a metropolitan region into one hundred different areas (cells) with low-power transmitters using twelve conversations (channels) each, the system capacity theoretically could be increased from twelve conversations— or voice channels using one powerful transmitter—to twelve hundred conversations (channels) using one hundred low-power transmitters. Figure 2.2 shows a metropolitan area configured as a traditional mobile telephone network with one high-power transmitter (Reed, 2014).



**Figure 2. 2:** Early Mobile Telephone System Architecture

### **2.2.4 Mobile Telephone System Using the Cellular Concept**

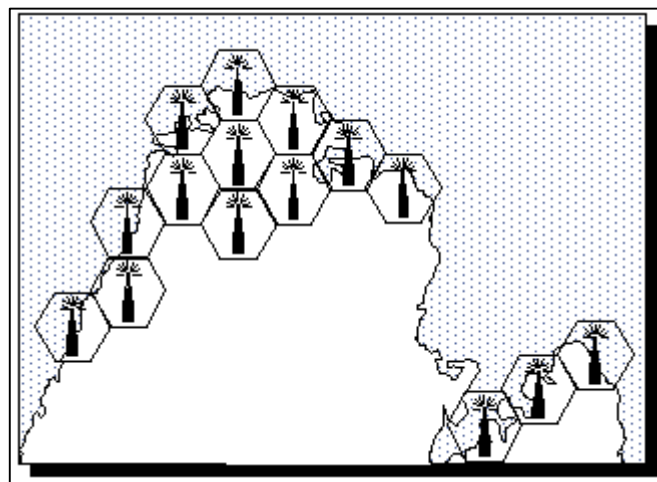
Interference problems caused by mobile units using the same channel in adjacent areas proved that all channels could not be reused in every cell. Areas had to be skipped before the same channel could be reused. Even though this affected the efficiency of the original concept, frequency reuse was still a viable solution to the problems of mobile telephony systems (Poole, 2006).

Engineers discovered that the interference effects were not due to the distance between areas, but to the ratio of the distance between areas to the transmitter power (radius) of the areas. By reducing the radius of an area by fifty percent, service providers could increase the number of potential

customers in an area fourfold. Systems based on areas with a one-kilometer radius would have one hundred times more channels than systems with areas ten kilometers in radius. Speculation led to the conclusion that by reducing the radius of areas to a few hundred meters, millions of calls could be served (Poole, 2006).

The cellular concept employs variable low-power levels, which allows cells to be sized according to the subscriber density and demand of a given area. As the population grows, cells can be added to accommodate that growth. Frequencies used in one cell cluster can be reused in other cells (Poole, 2006).

Conversations can be handed off from cell to cell to maintain constant phone service as the user moves between cells (see Figure 2. 3).



**Figure 2. 3:** Mobile Telephone System Using a Cellular Architecture

The cellular radio equipment (base station) can communicate with mobiles as long as they are within range. Radio energy dissipates over distance, so the mobiles must be within the operating range of the base station. Like the early mobile radio system, the base station communicates with mobiles via a channel. The channel is made of two frequencies, one for transmitting to the base station and one to receive information from the base station (Poole, 2006).

## **2.2.5 Cellular System Architecture**

Increases in demand and the poor quality of existing service led mobile service providers to research ways to improve the quality of service and to support more users in their systems. Because the amount of frequency spectrum available for mobile cellular use was limited, efficient use of the required frequencies was needed for mobile cellular coverage. In modern cellular telephony, rural and urban regions are divided into areas according to specific provisioning guidelines. Deployment parameters, such as amount of cell-splitting and cell sizes, are determined by engineers experienced in cellular system architecture (Lee, 2005).

Provisioning for each region is planned according to an engineering plan that includes cells, clusters, frequency reuse, and handovers.

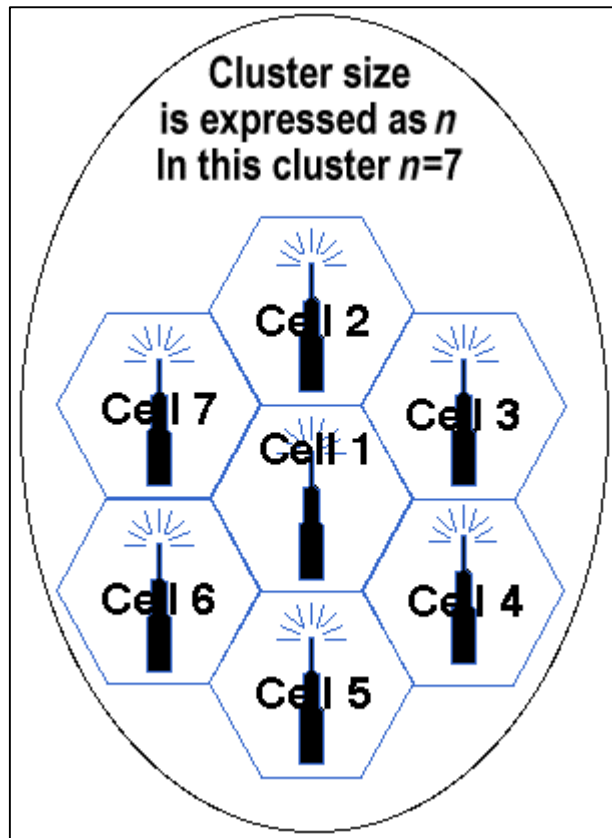
### **2.2.5.1 Cells**

A cell is the basic geographic unit of a cellular system.

The term cellular comes from the honeycomb shape of the areas into which a coverage region is divided. Cells are base stations transmitting over small geographic areas that are represented as hexagons. Each cell size varies depending on the landscape. Because of constraints imposed by natural terrain and man-made structures, the true shape of cells is not a perfect hexagon (Lee, 2005).

### **2.2.5.2 Clusters**

A cluster is a group of cells. No channels are reused within a cluster. Figure 2.4 illustrates a seven-cell cluster.

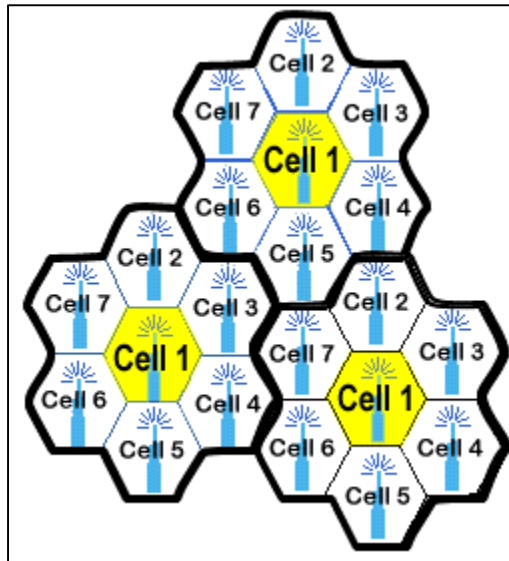


**Figure 2. 4:** A Seven-Cell Cluster

### 2.2.5.3 Frequency Reuse

Because only a small number of radio channel frequencies were available for mobile systems, engineers had to find a way to reuse radio channels in order to carry more than one conversation at a time. The solution the industry adopted was called frequency planning or frequency reuse. Frequency reuse was implemented by restructuring the mobile telephone system architecture into the cellular concept (Lee, 2005).

The concept of frequency reuse is based on assigning to each cell a group of radio channels used within a small geographic area. Cells are assigned a group of channels that is completely different from neighboring cells. The coverage area of cells are called the footprint. This footprint is limited by a boundary so that the same group of channels can be used in different cells that are far enough away from each other so that their frequencies do not interfere (see Figure 2. 5).



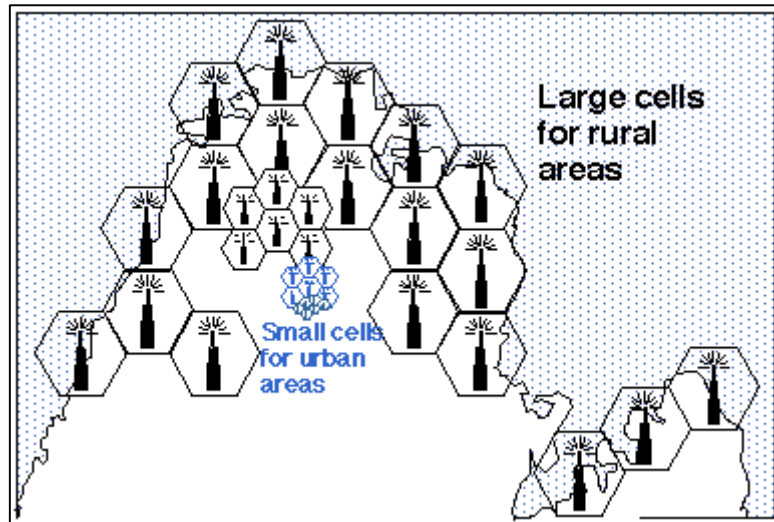
**Figure 2. 5:** Frequency Reuse

Cells with the same number have the same set of frequencies. Here, because the number of available frequencies is 7, the frequency reuse factor is  $1/7$ . That is, each cell is using  $1/7$  of available cellular channels (Lee, 2005).

#### **2.2.5.4 Cell Splitting**

Unfortunately, economic considerations made the concept of creating full systems with many small areas impractical. To overcome this difficulty, system operators developed the idea of cell splitting. As a service area becomes full of users, this approach is used to split a single area into smaller ones. In this way, urban centers can be split into as many areas as necessary in order to provide acceptable service levels in heavy-traffic regions, while larger, less expensive cells can be used to cover remote rural regions (see Figure 2. 6) (Lee, 2005).

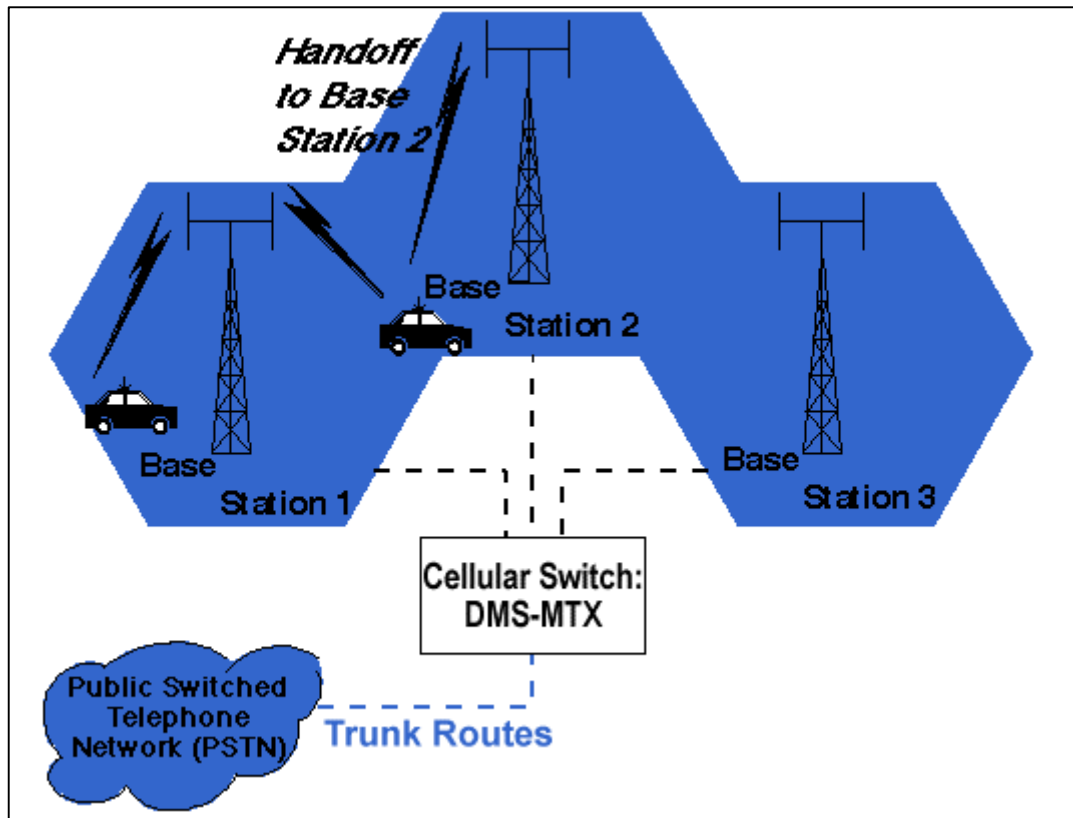




**Figure 2. 6: Cell Splitting**

#### **2.2.5.4 Handoff**

The final obstacle in the development of the cellular network involved the problem created when a mobile subscriber traveled from one cell to another during a call. As adjacent areas do not use the same radio channels, a call must either be dropped or transferred from one radio channel to another when a user crosses the line between adjacent cells. Because dropping the call is unacceptable, the process of handoff was created. Handoff occurs when the mobile telephone network automatically transfers a call from radio channel to radio channel as a mobile crosses adjacent cells (see Figure 2. 7).



**Figure 2. 7:** Handoff between Adjacent Cells

During a call, two parties are on one voice channel. When the mobile unit moves out of the coverage area of a given cell site, the reception becomes weak. At this point, the cell site in use requests a handoff. The system switches the call to a stronger-frequency channel in a new site without interrupting the call or alerting the user. The call continues as long as the user is talking, and the user does not notice the handoff at all (McNally et al., 2007).

### **2.2.6 North American Analog Cellular Systems**

Originally devised in the late 1970s to early 1980s, analog systems have been revised somewhat since that time and operate in the 800-MHz range. A group of government, telco, and equipment manufacturers worked together as a committee to develop a set of rules (protocols) that govern how cellular subscriber units (mobiles) communicate with the "cellular system." System development takes into consideration many different, and often opposing, requirements for the system, and often a compromise between conflicting

requirements results. Cellular development involves some basic topics (McNally et al., 2007):

1. frequency and channel assignments
2. type of radio modulation
3. maximum power levels
4. modulation parameters
5. messaging protocols
6. call-processing sequences

### **2.2.7 The Advanced Mobile Phone Service (AMPS)**

AMPS was released in 1983 using the 800-MHz to 900-MHz frequency band and the 30 kHz bandwidth for each channel as a fully automated mobile telephone service. It was the first standardized cellular service in the world and is currently the most widely used standard for cellular communications. Designed for use in cities, AMPS later expanded to rural areas. It maximized the cellular concept of frequency reuse by reducing radio power output. The AMPS telephones (or handsets) have the familiar telephone-style user interface and are compatible with any AMPS base station. This makes mobility between service providers (roaming) simpler for subscribers. Limitations associated with AMPS include (McNally et al., 2007):

1. low calling capacity
2. limited spectrum
3. no room for spectrum growth
4. poor data communications
5. minimal privacy
6. inadequate fraud protection

AMPS is used throughout the world and is particularly popular in the United States, South America, China, and Australia. AMPS uses frequency modulation (FM) for radio transmission. In the United States, transmissions

from mobile to cell site use separate frequencies from the base station to the mobile subscriber.

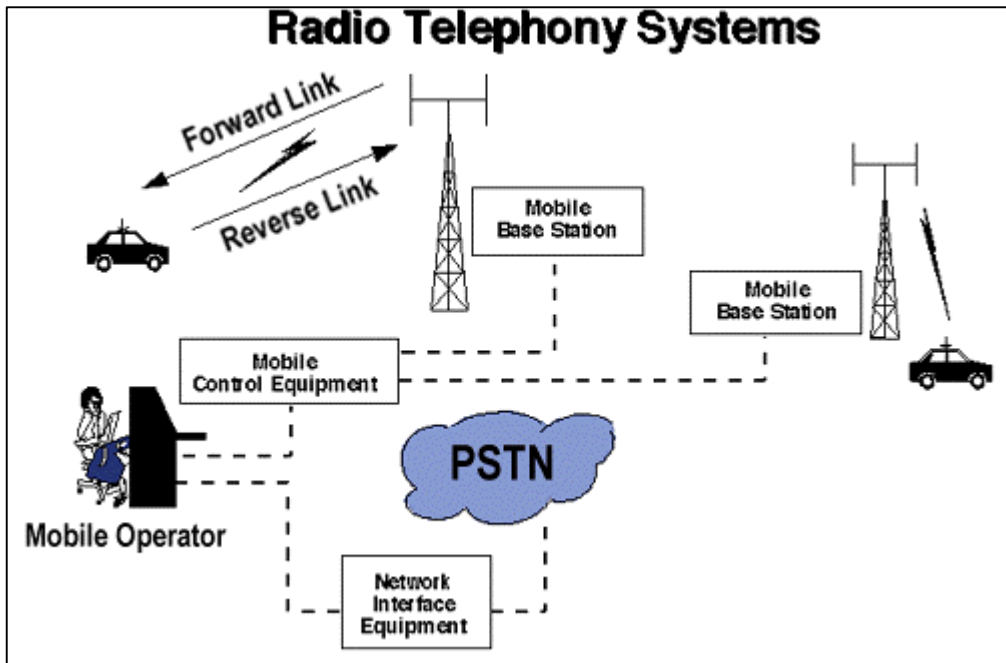
### **2.2.7 Narrowband Analog Mobile Phone Service (NAMPS)**

Since analog cellular was developed, systems have been implemented extensively throughout the world as first-generation cellular technology. In the second generation of analog cellular systems, NAMPS was designed to solve the problem of low calling capacity. NAMPS is now operational in 35 U.S. and overseas markets and NAMPS was introduced as an interim solution to capacity problems. NAMPS is a U.S. cellular radio system that combines existing voice processing with digital signaling, tripling the capacity of today's AMPS systems. The NAMPS concept uses frequency division to get three channels in the AMPS 30-kHz single channel bandwidth. NAMPS provides three users in an AMPS channel by dividing the 30-kHz AMPS bandwidth into three 10-kHz channels. This increases the possibility of interference because channel bandwidth is reduced (McNally et al., 2007).

### **2.2.8 Cellular System Components**

The cellular system offers mobile and portable telephone stations the same service provided fixed stations over conventional wired loops. It has the capacity to serve tens of thousands of subscribers in a major metropolitan area. The cellular communications system consists of the following four major components that work together to provide mobile service to subscribers (see Figure 2. 8) (Tripathi & Reed, 2014):

1. Public Switched Telephone Network (PSTN)
2. Mobile Telephone Switching Office (MTSO)
3. Cell Site with Antenna System
4. Mobile Subscriber Unit (MSU)



**Figure 2. 8:** Cellular System Components

### 2.2.8.1 PSTN

The PSTN is made up of local networks, the exchange area networks, and the long-haul network that interconnect telephones and other communication devices on a worldwide basis (Taylor & Francis, 2012).

### 2.2.8.2 Mobile Telephone Switching Office (MTSO)

The MTSO is the central office for mobile switching. It houses the mobile switching center (MSC), field monitoring and relay stations for switching calls from cell sites to wireline central offices (PSTN). In analog cellular networks, the MSC controls the system operation. The MSC controls calls, tracks billing information, and locates cellular subscribers (Taylor & Francis, 2012).

### 2.2.8.3 The Cell Site

The term cell site is used to refer to the physical location of radio equipment that provides coverage within a cell. A list of hardware located at a cell site

includes power sources, interface equipment, radio frequency transmitters and receivers, and antenna systems (Taylor & Francis, 2012).

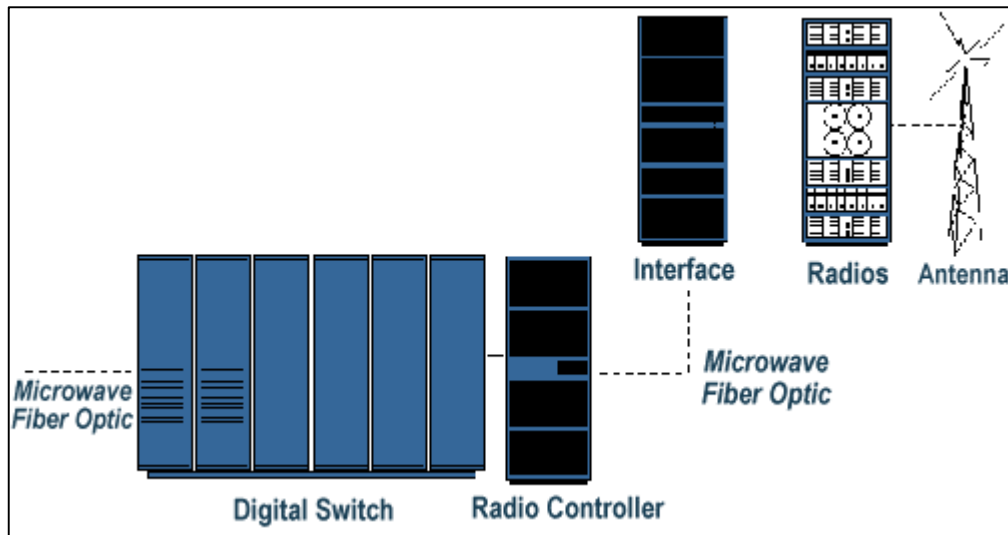
**Mobile Subscriber Units (MSUs)** The mobile subscriber unit consists of a control unit and a transceiver that transmits and receives radio transmissions to and from a cell site. Three types of MSUs are available:

1. The mobile telephone (typical transmit power is 4.0 watts)
2. The portable (typical transmit power is 0.6 watts)
3. The transportable (typical transmit power is 1.6 watts)

The mobile telephone is installed in the trunk of a car, and the handset is installed in a convenient location to the driver. Portable and transportable telephones are hand-held and can be used anywhere. The use of portable and transportable telephones is limited to the charge life of the internal battery.

### **2.2.9 Digital Systems**

As demand for mobile telephone service has increased, service providers found that basic engineering assumptions borrowed from wireline (landline) networks did not hold true in mobile systems. While the average landline phone call lasts at least ten minutes, mobile calls usually run ninety seconds. Engineers who expected to assign fifty or more mobile phones to the same radio channel found that by doing so they increased the probability that a user would not get dial tone—this is known as call-blocking probability. As a consequence, the early systems quickly became saturated, and the quality of service decreased rapidly. The critical problem was capacity. The general characteristics of TDMA, GSM, PCS1900, and CDMA promise to significantly increase the efficiency of cellular telephone systems to allow a greater number of simultaneous conversations. Figure 2.9 shows the components of a typical digital cellular system (Stüber, 2017).



**Figure 2. 9:** Digital Cellular System

The advantages of digital cellular technologies over analog cellular networks include increased capacity and security. Technology options such as TDMA and CDMA offer more channels in the same analog cellular bandwidth and encrypted voice and data. Because of the enormous amount of money that service providers have invested in AMPS hardware and software, providers look for a migration from AMPS to DAMPS by overlaying their existing networks with TDMA architectures (Stüber, 2017).

### **2.2.9.1 Time Division Multiple Access (TDMA)**

North American digital cellular (NADC) is called DAMPS and TDMA. Because AMPS preceded digital cellular systems, DAMPS uses the same setup protocols as analog AMPS. TDMA has the following characteristics:

1. IS-54 standard specifies traffic on digital voice channels
2. Initial implementation triples the calling capacity of AMPS systems
3. Capacity improvements of 6 to 15 times that of AMPS are possible
4. Uses many blocks of spectrum in 800 MHz and 1900 MHz
5. All transmissions are digital
6. TDMA/FDMA application

TDMA is one of several technologies used in wireless communications. TDMA provides each call with time slots so that several calls can occupy one bandwidth. Each caller is assigned a specific time slot. In some cellular systems, digital packets of information are sent during each time slot and reassembled by the receiving equipment into the original voice components. TDMA uses the same frequency band and channel allocations as AMPS. Like NAMPS, TDMA provides three to six time channels in the same bandwidth as a single AMPS channel. Unlike NAMPS, digital systems have the means to compress the spectrum used to transmit voice information by compressing idle time and redundancy of normal speech. TDMA is the digital standard and has 30-kHz bandwidth. Using digital voice encoders, TDMA is able to use up to six channels in the same bandwidth where AMPS uses one channel (Stüber, 2017).

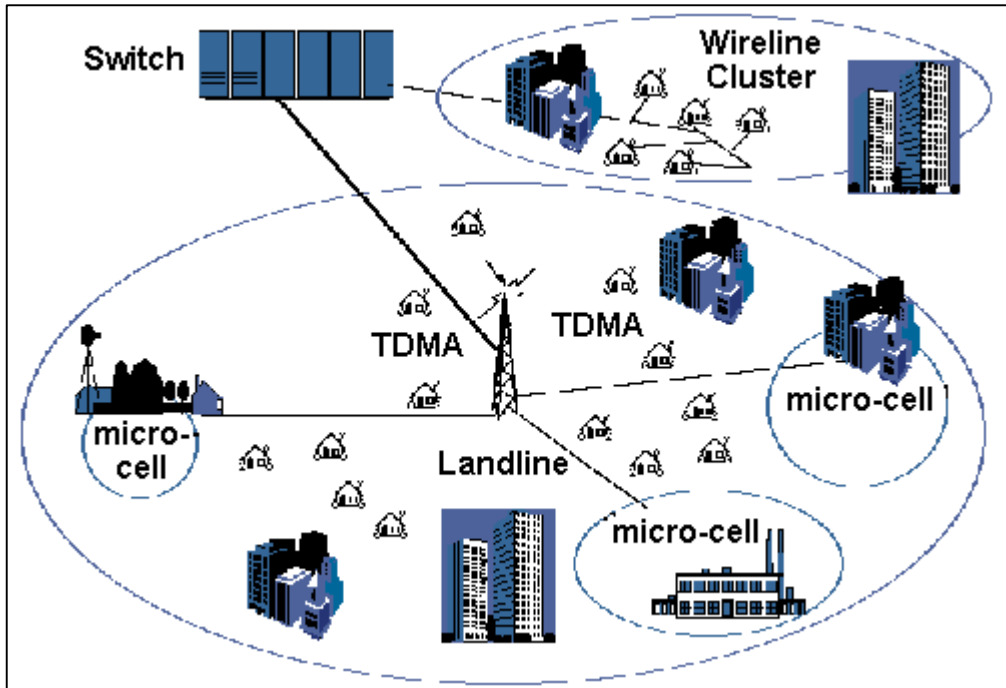
#### **2.2.9.2 Extended Time Division Multiple Access (E-TDMA)**

The extended TDMA (E-TDMA) standard claims a capacity of fifteen times that of analog cellular systems. This capacity is achieved by compressing quiet time during conversations. E-TDMA divides the finite number of cellular frequencies into more time slots than TDMA. This allows the system to support more simultaneous cellular calls (Stüber, 2017).

#### **2.2.9.3 Fixed Wireless Access (FWA)**

Fixed wireless access (FWA) is a radio-based local exchange service in which telephone service is provided by common carriers (see Figure 2. 10). It is primarily arural application—that is, it reduces the cost of conventional wireline. FWA extends telephone service to rural areas by replacing a wireline local loop with radio communications. Other labels for wireless access include fixed loop, fixed radio access, wireless telephony, radio loop, fixed wireless, radio access, and Ionica. FWA systems employ TDMA or CDMA access technologies (Stüber, 2017).





**Figure 2. 10:** Fixed Wireless Access

#### **2.2.9.4 Personal Communications Services (PCS)**

The future of telecommunications includes personal communications services. PCS at 1900 MHz (PCS1900) is the North American implementation of DCS1800 (Global System for Mobile communications, or GSM). Trial networks were operational in the United States by 1993, and in 1994 the Federal Communications Commission (FCC) began spectrum auctions. As of 1995, the FCC auctioned commercial licenses. In the PCS frequency spectrum the operator's authorized frequency block contains a definite number of channels. The frequency plan assigns specific channels to specific cells, following a reuse pattern which restarts with each  $n$ th cell. The uplink and downlink bands are paired mirror images. As with AMPS, a channel number implies one uplink and one downlink frequency: e.g., Channel 512 = 1850.2 MHz uplink paired with 1930.2 MHz downlink (Stüber, 2017).

Code Division Multiple Access (CDMA) Code division multiple access (CDMA) is a digital air interface standard, claiming eight to fifteen times the

capacity of analog. It employs a commercial adaptation of military spread-spectrum single-sideband technology. Based on spread spectrum theory, it is essentially the same as wireline service—the primary difference is that access to the local exchange carrier (LEC) is provided via wireless phone. Because users are isolated by code, they can share the same carrier frequency, eliminating the frequency reuse problem encountered in AMPS and DAMPS. Every CDMA cell site can use the same 1.25 MHz band, so with respect to clusters,  $n = 1$ . This greatly simplifies frequency planning in a fully CDMA environment (Stüber, 2017).

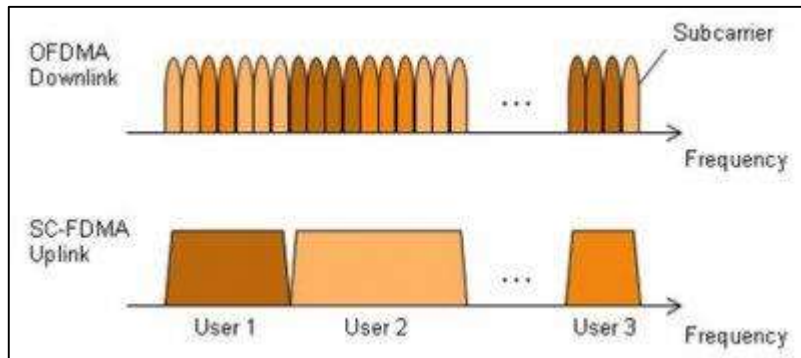
CDMA is an interference limited system. Unlike AMPS/TDMA, CDMA has a soft capacity limit; however, each user is a noise source on the shared channel and the noise contributed by users accumulates. This creates a practical limit to how many users a system will sustain. Mobiles that transmit excessive power increase interference to other mobiles. For CDMA, precise power control of mobiles is critical in maximizing the system's capacity and increasing battery life of the mobiles. The goal is to keep each mobile at the absolute minimum power level that is necessary to ensure acceptable service quality. Ideally, the power received at the base station from each mobile should be the same (minimum signal to interference) (Stüber, 2017).

## **2.3 LTE**

### **2.3.1 Introduction**

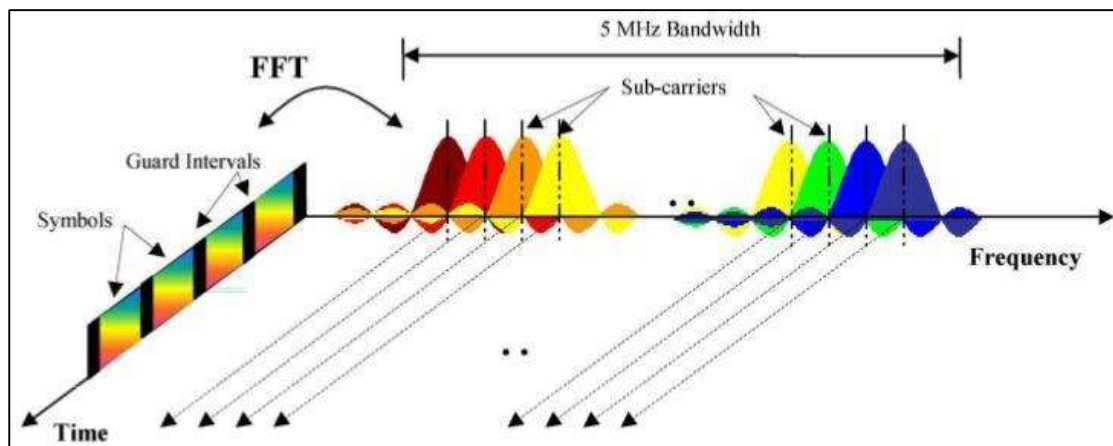
LTE is based on orthogonal frequency division multiplexing (OFDM) thus enabling it to transmit efficiently over higher bandwidths while being resilient to the channel conditions and interference. In the downlink, i.e. from base station to the user equipment, LTE uses OFDMA (Orthogonal Frequency Division Multiple Access) and in the uplink, i.e. from user equipment to the base station, it uses SC-FDMA (Single Carrier - Frequency Division Multiple Access). The SC-FDMA is adopted for uplink due to its low peak-to-average power ratio (PAPR) when compared to OFDMA. This

enables a better coverage in the uplink by utilizing the power amplifier efficiently (Rumney, 2013).



**Figure 2. 11 : OFDMA and SC-FDMA**

The OFDM splits the wideband carrier in to multiple overlapping narrowband orthogonal subcarriers for carrying the data. A frequency-time domain representation of a 5 MHz OFDM signal is shown in the below Figure 2.12: Frequency-time domain representation of OFDM signal (Rumney, 2013).



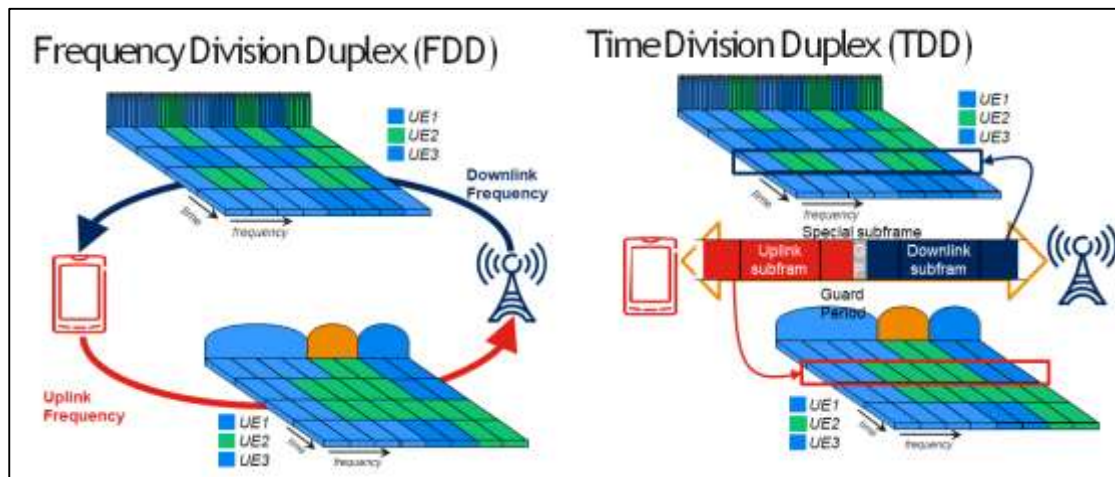
**Figure 2. 12: Frequency-time domain representation of OFDM signal**

OFDMA technology has been incorporated into LTE because it enables high data bandwidths to be transmitted efficiently while still providing a high degree of resilience to reflections and interference (Rumney, 2013).

LTE was initially designed to support a scalable bandwidth (BW) of up to 20 MHz with a peak data rate of 300 Mbps using a  $4 \times 4$  multiple input multiple output (MIMO) configuration and 64 QAM modulation, and later extended to support up to 100 MHz by aggregating five 20 MHz carriers. A unified frame and symbol structure is defined for all the supported bandwidths with the same subcarrier spacing of 15 KHz (Rumney, 2013).

### 2.3.2 LTE Frame Structure

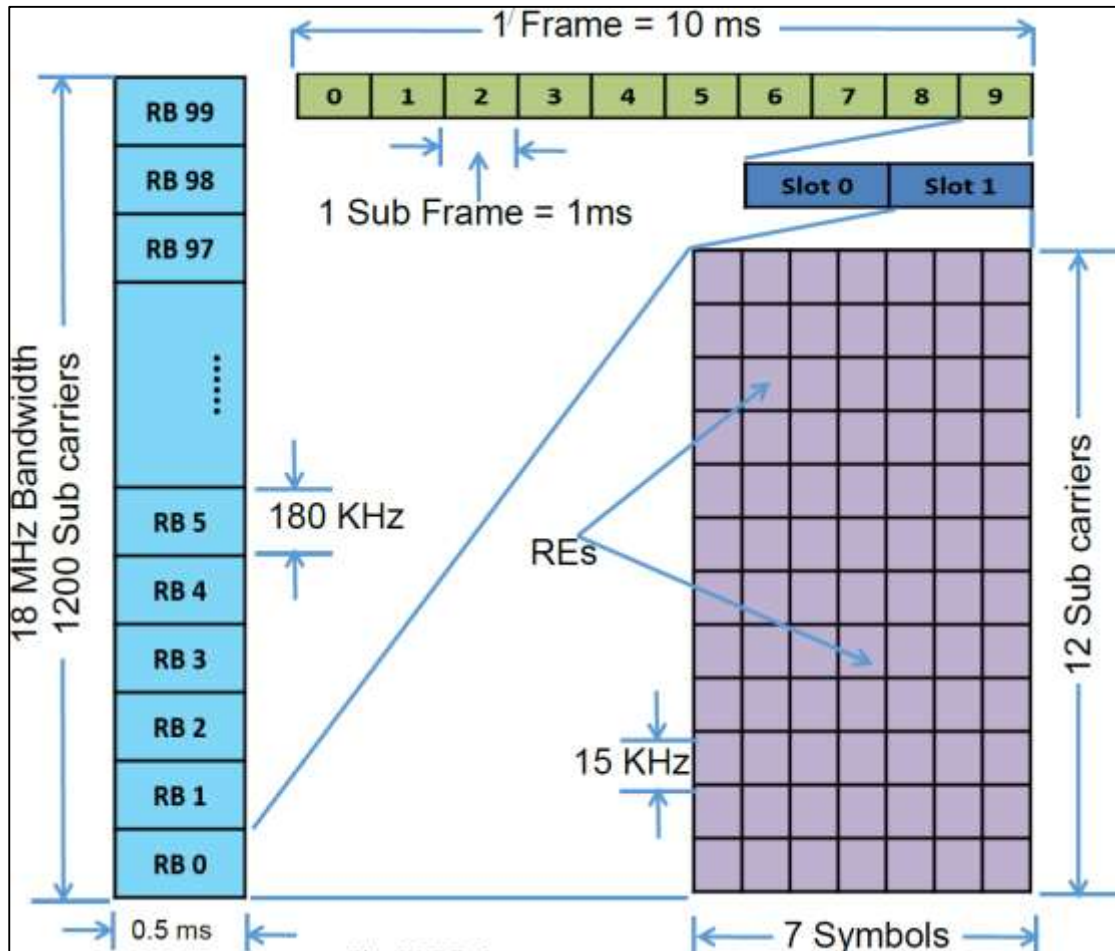
LTE uses OFDM as its waveform, and defines two types of frame structures for frequency division duplex (FDD) and time division duplex (TDD) mode (Holma & Toskala, 2012).



**Figure 2. 13: FDD & TDD**

The radio frame length is of 10 ms duration, and it is divided into 10 subframes each of 1 ms duration. Each subframe consists of two slots each of length 0.5 ms. Each slot contains 7 (for normal CP) or 6 (for extended CP) OFDM symbols. The unit of allocation is in terms of resource blocks (RB) which composed of one slot duration and 12 subcarriers. Scheduling is done in terms of RB pairs. A resource element (RE) is the smallest element in the RB which is of one subcarrier for one OFDM symbol duration. Therefore, a

RB consists of 84 REs (for normal CP), or 72 REs (for extended CP) (Holma & Toskala, 2012).



**Figure 2. 14:** Frame structure used for FDD

It is to be noted that not all subcarriers are used for transmission. For example, dc subcarrier and the subcarriers at the edges are left as guard band. There are 100 RBs in a 20 MHz BW (Holma & Toskala, 2012).

### 2.3.3 Spatial Multiplexing

Spatial multiplexing (SM) allows transmitting different data streams on the same time and frequency resource by exploiting the spatial dimension of the radio channel. When this is performed to increase the spectral efficiency by exploiting the multiple antennas at the eNodeB and a single user, it is called as single user MIMO (SU-MIMO). When the multiple antennas at the eNodeB and the multiple antennas located across users located in different

geographical location are exploited to increase the overall system throughput, it is called as multiuser MIMO (MU-MIMO) (Dahlman, 2013).

### **2.3.4 Transmit Diversity**

Transmit Diversity schemes play a key role in ensuring reliable communication in fading scenarios. It helps to improve the robustness of the data transmission by sending replicas over multiple transmit antennas. An antenna specific code w.r.t. channel is applied on the signal before transmission to achieve the diversity gain at the receiver. Appropriate MIMO modes are chosen based on the user velocity, channel signal to interference plus noise ratio (SINR), and user equipment (UE) capability (Cox, 2012).

### **2.3.5 Link Adaptation**

Link Adaptation is a technique used by the eNodeB to select appropriate modulation and coding rate based on the channel quality information feedback by the UE to maximize the throughput. The UE computes the post processing SINR of the receiver, and map to appropriate MCS supported by LTE and the index is reported back to the eNodeB (Zaki, 2012).

### **2.3.6 Rate Matching**

The data transmitted to the UE in LTE are in terms of transport blocks (TBs). The TB size in LTE is of pre-determined lengths, and moreover, the allocation of resources is in terms of multiples of RB pairs. The chosen TB size may not match the size of the allocated resources. To fit the TB in the allocated resources, some of the bits will be punctured, or more redundant bits are added depending on the bits in the TB and the number of bits the allocated resources can accommodate. Puncturing and repetition will result in increasing and decreasing the code rate, respectively (Sauter, 2011).

### 2.3.7 LTE deployment methodology

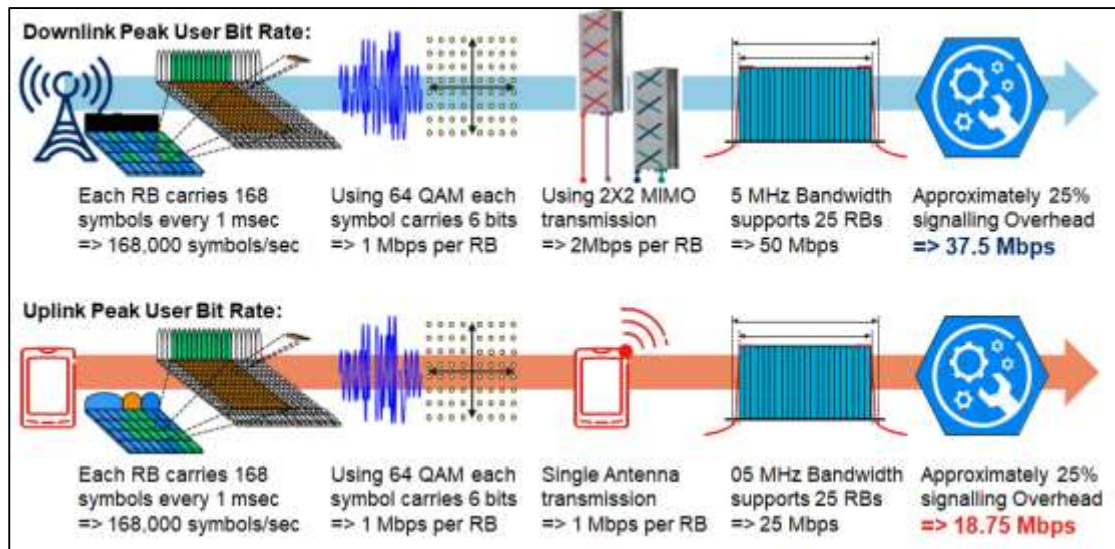


Figure 2. 15: LTE Peak User Bit Rates at 05MHz BW

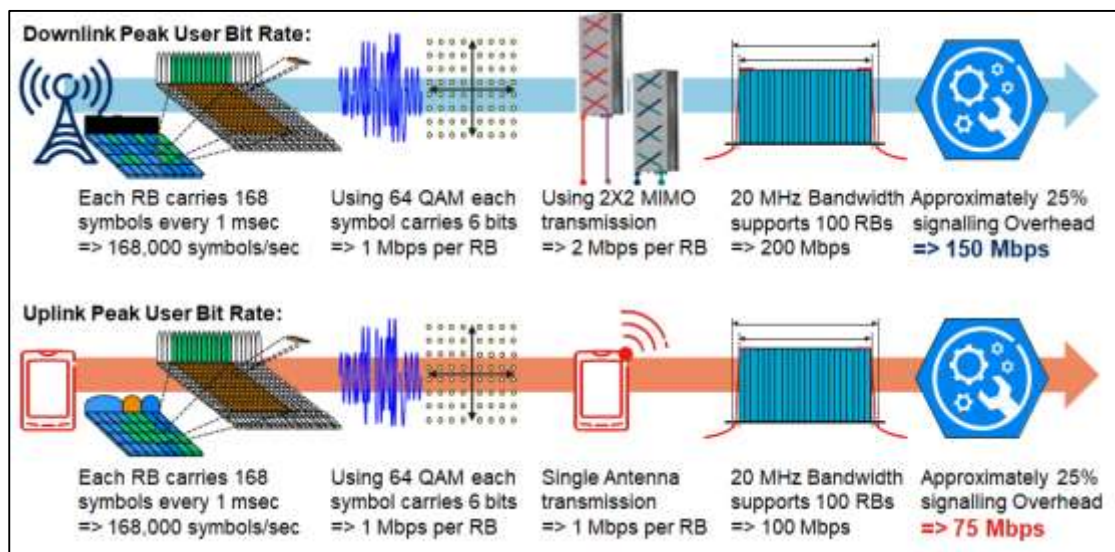


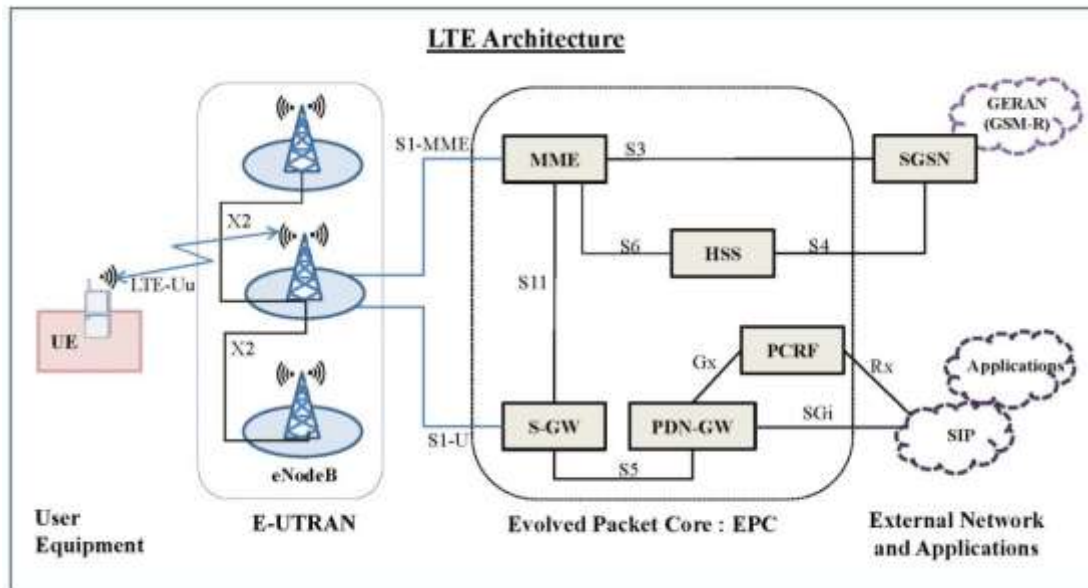
Figure 2. 16: LTE Peak User Bit Rates at 20MHz BW

### 2.3.8 Architecture of LTE System

The LTE network called EPS is divided into two parts - LTE part which deals with the technology related to a radio access network Evolved Universal Terrestrial Radio Access Network (E-UTRAN) and Evolved Packet Core (EPC) part which deals with the technology related to a core

network. User Equipment (UE) is connected to the EPC over E-UTRAN (LTE access network) (Zeadally et al., 2013).

The Evolved NodeB (eNodeB) is the base station for LTE radio. The EPC is composed of five network elements: the Serving Gateway (Serving GW), the PDN Gateway (PDN GW), the MME, PCRF and the HSS (Figure 2.17: LTE Architecture) (Zeadally et al., 2013).

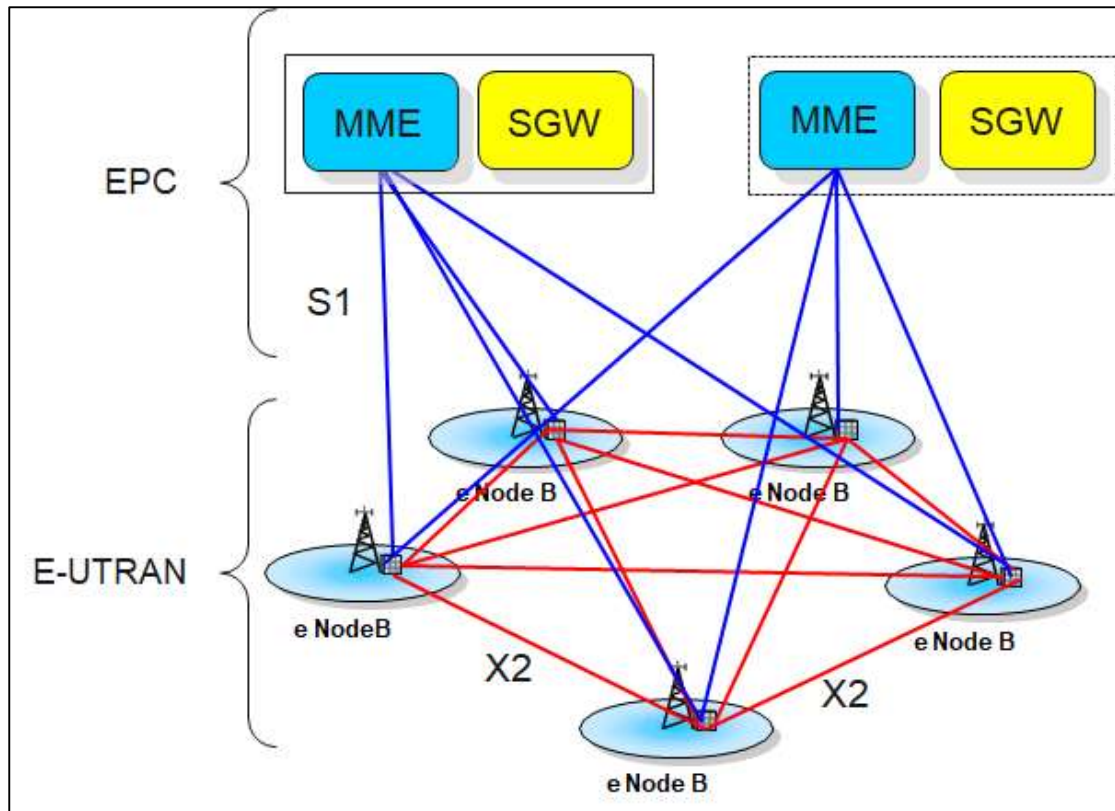


**Figure 2. 17:** LTE Architecture

2.3.9 Evolved Universal Terrestrial Radio Access Network (E-UTRAN)  
 E-UTRAN or LTE is the access part of the Evolved Packet System (EPS). E-UTRAN is a radio access network (RAN) of base stations called evolved NodeB (eNB) through which the user equipment (UE) are linked to the LTE core network. There is no centralized intelligent controller, and the eNBs are normally inter-connected via the X2-interface and towards the core network by the S1-interface. The reason for distributing the intelligence amongst the base-stations in LTE is to speed up the connection set-up and reduce the time required for a handover (Zeadally et al., 2013).

It provides higher data rates, lower latency and is optimized for packet data. It uses OFDMA radio-access for the downlink and SC-FDMA on the uplink (Zeadally et al., 2013).





**Figure 2. 18: E-UTRAN**

### 2.3.10 Evolved NodeB (eNB)

The Evolved NodeB (eNodeB) is the base station for LTE radio. eNodeB is the RAN (Radio Access Network) node in the network architecture that is responsible for radio transmission to and reception from UEs ( User Equipment) in one or more cells.

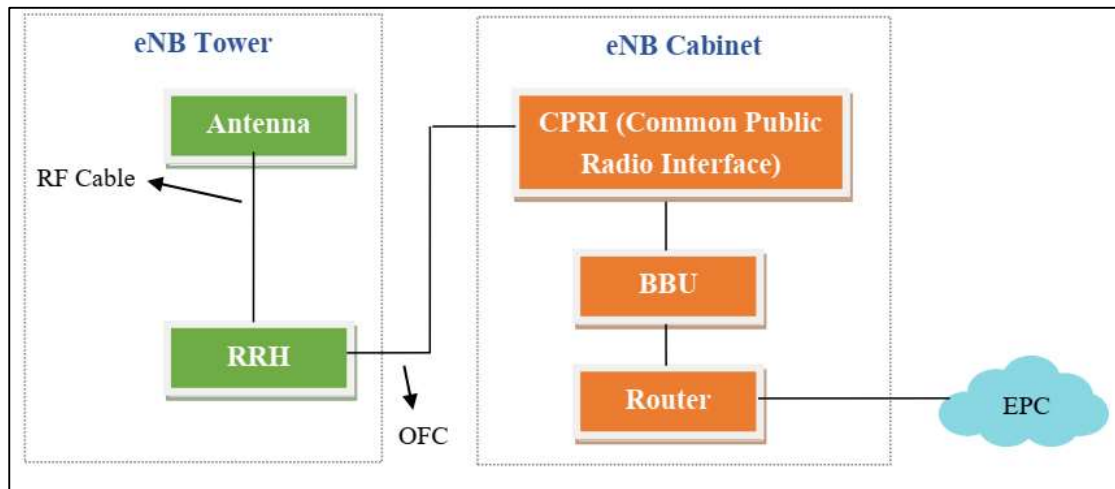
The radio coverage area of an eNodeB is called a cell. Accordingly, the cell site is where the eNodeB radio equipment and its antennas are placed.

The eNodeB is connected to EPC nodes by means of an S1 interface. The eNodeB is also connected to its neighbor eNodeBs by means of the X2 interface. eNB is equivalent of BSS in GSM-R (Ghosh, 2011).

Physically the eNodeB consists of the followings:

- Antenna
- Remote Radio Head (RRH)

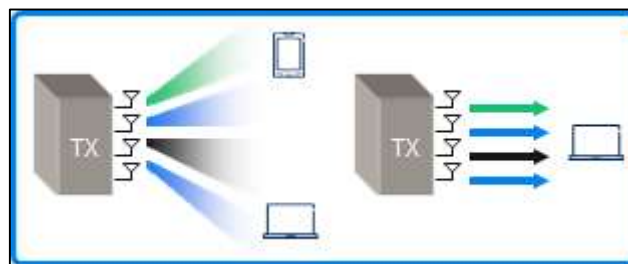
- Baseband Unit (BBU)



**Figure 2. 19:** Equipment block diagram of eNB

### 2.3.10.1 Antenna

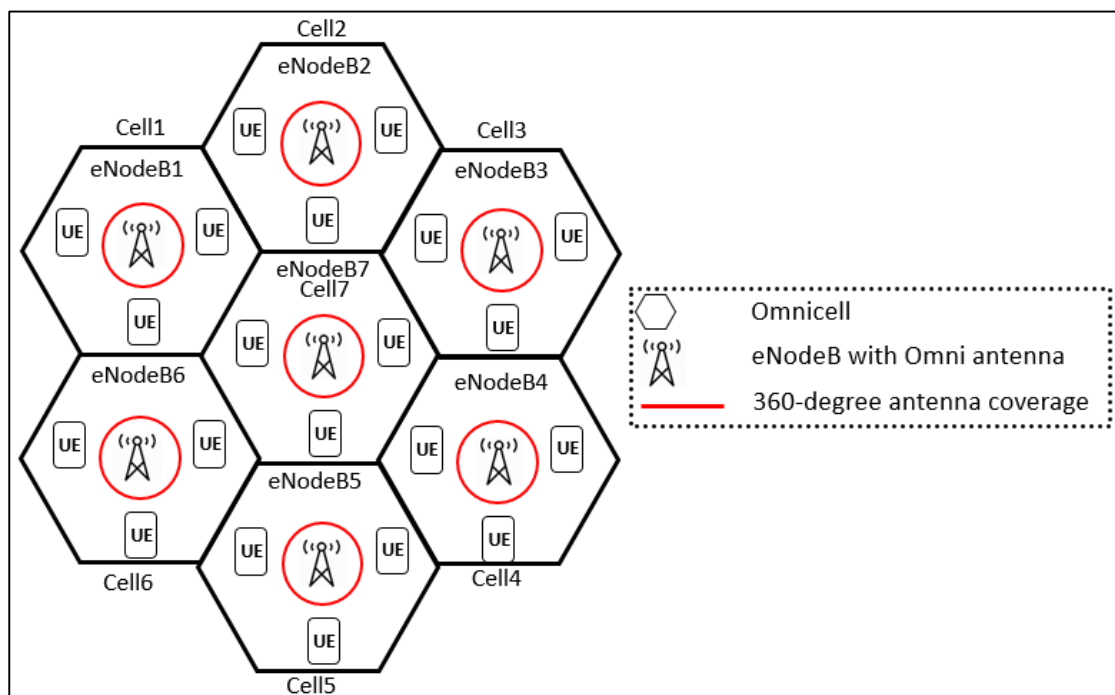
LTE adopts multiple input multiple output (MIMO) as the antenna technology. MIMO is a technique where multiple antennas are used at both the transmitter and the receiver to increase the link reliability and the spectral efficiency. One of the main problems that previous telecommunications systems have encountered is that of multiple signals arising from the many reflections that are encountered in antenna deployments. By using MIMO, these additional signal paths can be used to advantage and are able to be used to increase the throughput (Ghosh, 2011).



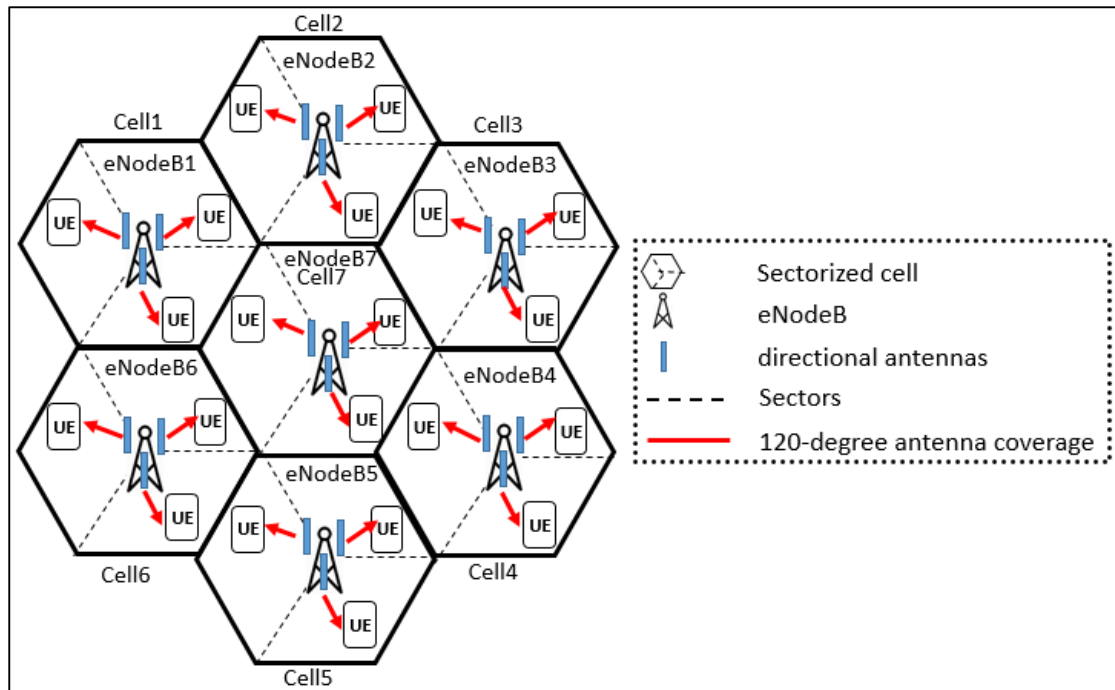
**Figure 2. 20:** MIMO

Based on the antenna type, there can be two types of cell deployments: omnidirectional cell and sectorized cell. The omnidirectional cell also called omniscell, includes an Omni antenna to cover the signals in 360-degree field which practically means in all directions.

In contrast to omniceils, the sectorized cells have been designed to enhance the cellular system capacity. The sectorization refers to when cells are divided into different parts called sector. The antenna for eNodeB is replaced with sector antenna owning different order of sectorization, e.g. three, six, or nine with 120, 60, 40 degrees' coverage, respectively, where each sector is covered by one of the sector antennas. The importance of cell sectorization is mainly due to improving the transmission capabilities and capacity gain and thereby, it is widely used by mobile communication industries to increase the data rate.



**Figure 2. 21:** Typical structure of LTE omniceils



**Figure 2. 22:** Typical structure of LTE 3-sector cells (each cell includes 3 x 120 degree sectors)

### 2.3.10.2 Remote Radio Head (RRH)

An RRH transmits and receives wireless signals. An RRH converts the digital baseband signals from BBU that have been subjected to protocol-specific processing into radio frequency (RF) signals and power-amplifies them to transmit to UE. The RF signals received from UE are amplified and converted to digital baseband signals for transmission to the BBU (Ghosh, 2011).



**Figure 2. 23:** Remote Radio Head

### 2.3.10.3 Baseband Unit (BBU)

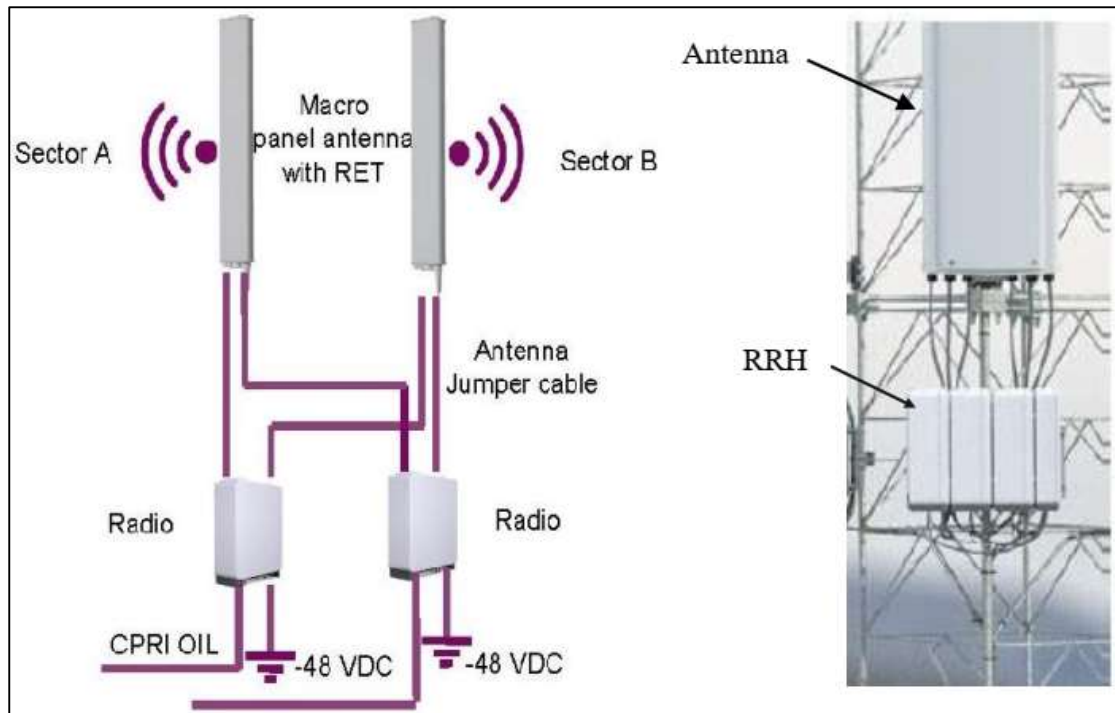
The BBU is responsible for digital baseband signal processing, termination of S1 line used for connecting with a core network, termination of X2 line used for connecting with the neighboring eNodeB, call processing and monitoring control processing. IP packets received from the core network are modulated into digital baseband signals and transmitted to the RRH(s). The digital baseband signals received from the RRH(s) are demodulated and IP packets are transmitted to the core network (Ghosh, 2011).



**Figure 2. 24:** Baseband Unit

The interfacing between BBU and RRH is with Optic Fibre Cable and compliant to the Common Public Radio Interface (CPRI) specification or OBSAI (Open Base Station Architecture Initiative) (Ghosh, 2011).

The BBU and RRH shall be designed to work in 5 MHz (paired) in 700 MHz band (703-748 MHz Uplink & 758-803 MHz Downlink) allocated to Indian Railways. The eNodeB (BBU and RRH) shall support Omni Cell and Cell Sectorization (Sectoring) and MIMO configuration as per site requirement (Ghosh, 2011).



**Figure 2. 25:** eNB Antenna with RRH



**Figure 2. 26:** eNB Antenna with RRH (Actual scenario)

### 2.3.11 Evolved Packet Core (EPC)

The Evolved packet Core (EPC) is the Core network of LTE system. It is a framework for providing converged voice and data on a LTE network. 2G and 3G network architectures process and switch voice and data through two separate sub-domains: circuit-switched (CS) for voice and packet-switched (PS) for data. Evolved Packet Core unifies voice and data on an Internet Protocol (IP ) service architecture and voice is treated as just another IP application. This allows operators to deploy and operate one packet network for 2G, 3G, and LTE (Ghosh, 2011).

EPC is composed of four network elements: Mobility Management Entity (MME), Home Subscriber Server (HSS), Serving Gateway (S-GW) and Packet Data Network Gateway (PGW) (Ghosh, 2011).

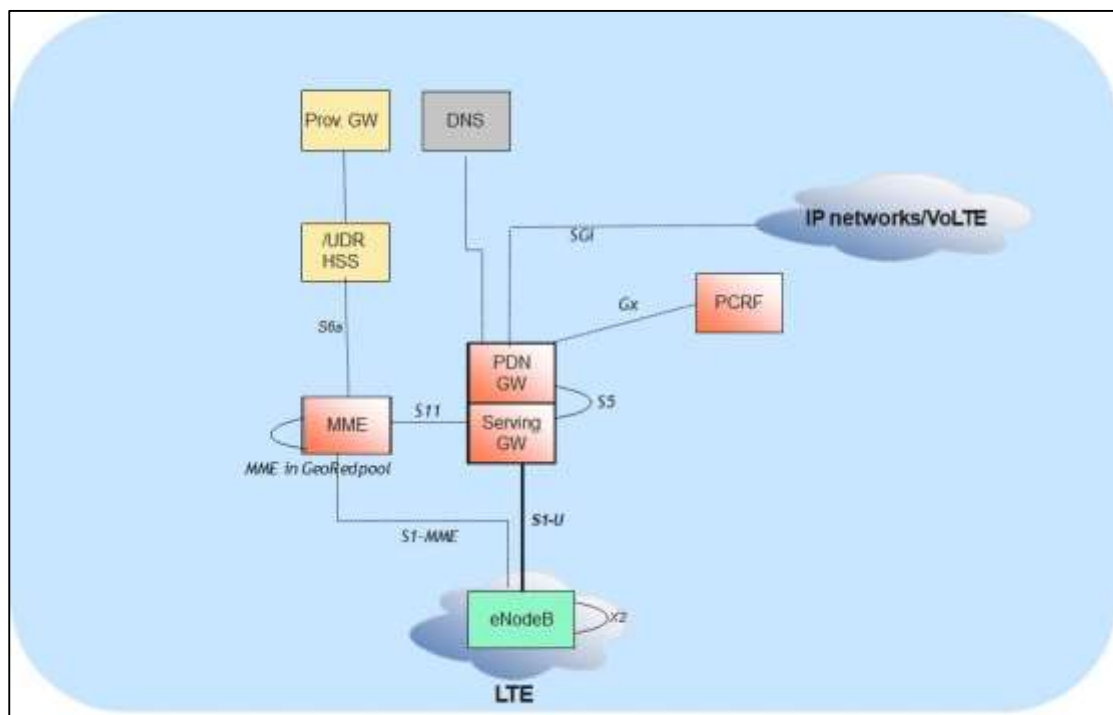


Figure 2. 27: EPC interfaces

#### 2.3.11.1 Mobility Management Entity (MME)

The MME is the key control-node for the LTE access-network. It handles the signalling related to mobility and security for E-UTRAN access. It is involved in the bearer activation/deactivation process and is also responsible for choosing the Serving Gateway for a UE at the initial attach and at time of

intra-LTE handover. It manages session states and is responsible for authenticating the user (by interacting with the Home Subscriber Server). It is responsible for the tracking and the paging of UE in idle-mode. It is the termination point of the Non-Access Stratum (NAS) signaling and is responsible for generation and allocation of temporary identities to UEs. The MME also provides the control plane function for mobility between LTE and 2G/3G access networks with the S3 interface and terminates the S6a interface towards the HSS for roaming UEs (Ghosh, 2011).

#### **2.3.11.2 Home Subscriber Server (HSS)**

The HSS (for Home Subscriber Server) is a database that contains user-related and subscriber related information. It also provides support functions in mobility management, call and session setup, user authentication and access authorization.

A Home Network may contain one or several HSSs: it depends on the number of mobile subscribers, on the capacity of the equipment and on the organization of the network (Ghosh, 2011).

#### **2.3.11.3 Serving Gateway (S-GW)**

The gateways (Serving GW and Packet Data Network GW) deal with the user plane. They transport the IP data traffic between the User Equipment (UE) and the external networks. The Serving GW is the point of interconnect between the radio-side and the EPC. As its name indicates, this gateway serves the UE by routing the incoming and outgoing IP packets. For each UE associated with the EPS, at a given point of time, there is a single Serving GW. For idle state User Equipment, the Serving Gateway terminates the downlink data path and triggers paging when downlink data arrives for the User Equipment (Ghosh, 2011).

It is the anchor point for the intra-LTE mobility (i.e. in case of handover between eNodeBs) and between LTE and other 3GPP accesses. It is logically connected to the other gateway, the PDN GW (Ghosh, 2011).



#### **2.3.11.4 Packet Data Network Gateway (P-GW)**

The PDN GW acts as the interface between the LTE network and the external IP networks. It manages quality of service (QoS). The PDN GW routes packets to and from the PDNs. The PDN GW performs policy enforcement, packet filtering for each user, charging support, lawful interception and packet screening. Another key role of the PDN GW is to act as the anchor for mobility between 3GPP and non-3GPP technologies such as WiMAX and 3GPP2 (Ghosh, 2011).

3GPP specifies these gateways independently but in practice they may be combined in a single "box" by network vendors. A piece of User Equipment (UE) may have simultaneous connectivity with more than one Packet Data Network Gateway for accessing multiple packet data networks. If a UE is accessing multiple PDNs, there may be more than one PDN GW for that UE (Ghosh, 2011).

The PDN GW and the Serving GW may be implemented in one physical node or separated physical nodes (Ghosh, 2011).

#### **2.3.11.5 Policy and Charging Rules Function (PCRF)**

The Policy and Charging Rules Function (PCRF), is a combination of the Charging Rules Function (CRF) and the Policy Decision Function (PDF). PCRF brings together and enhances capabilities from earlier 3GPP releases to deliver dynamic control of policy and charging on a per subscriber and per IP flow basis. It is responsible for policy control decision-making, as well as for controlling the flow-based charging functionalities in the Policy Control Enforcement Function (PCEF), which resides in the P-GW. The PCRF provides the QoS (Quality of Service) authorization that decides how a certain data flow will be treated in the PCEF and ensures that this is in accordance with the user's subscription profile (Ghosh, 2011).

In a nutshell, PCRF is the policy manager of the LTE technology. All the quality of service (QoS) rules and regulations are distributed to the PDN GW by the PCRF (Ghosh, 2011).

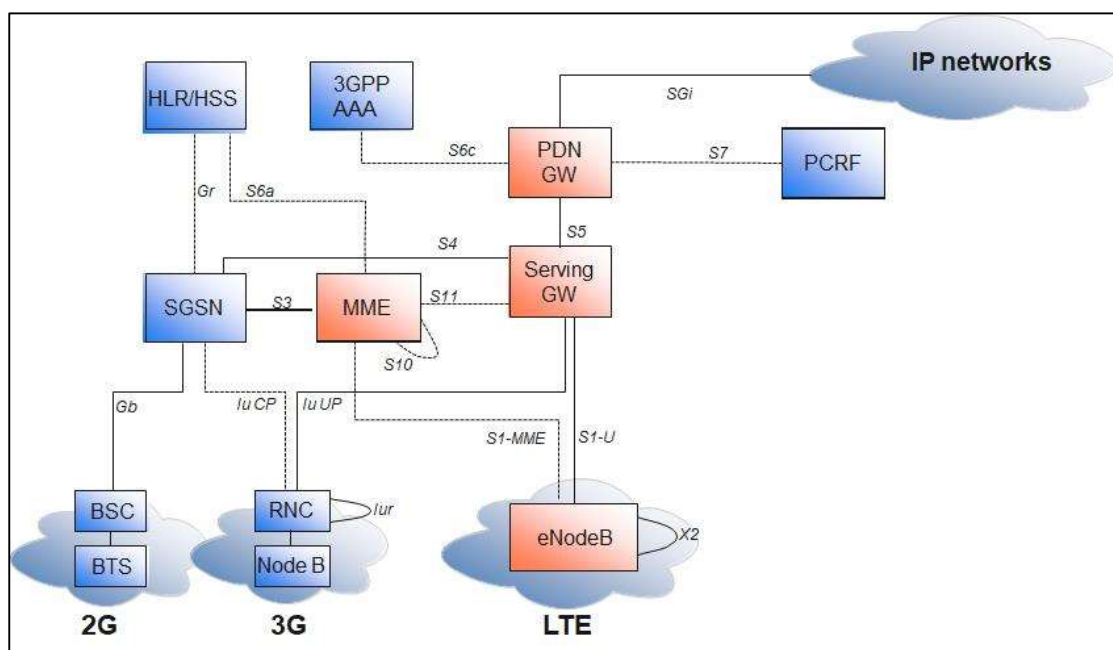
### 2.3.12 Interfaces in LTE

Interface represents a channel on which two network entities exchange information. Interfaces are needed in LTE to deliver information (signaling or user data) for a subscriber or network element. The various network interfaces are defined by 3GPP. All network vendors or manufacturers are required to comply with these standards (Sesia, 2011).

**Table 2. 1:** LTE Network Interfaces

Interface Name	Connecting Nodes
LTE-Uu	UE & eNB
S1-U	eNB & S-GW
S1-MME	eNB & MME
X2	eNB & eNB
S11	MME & S-GW
S5/ S8	S-GW & P-GW
S7	P-GW & PCRF
S10	MME & MME
S6a	MME & HSS

### 2.3.13 Network Evolution towards LTE



**Figure 2. 28:** Evolution of LTE

## **2.4 5G NR**

### **2.4.1 Introduction**

Fifth Generation (5G) of mobile communication, started from late 2010, aims to provide a better level of connectivity and coverage, complete wireless communication with almost no limitations and enhanced quality of service (QoS). It is highly supportable to WWW (Wireless World Wide Web) (Jonathan Rodriguez, 2015).

The 5G NR is a new aerial interface developed for 5G. This is the radio frequency part of the circuit between the mobile terminal and the base station.

5G will initially be available through improvements in LTE, LTE-Advanced and LTE Pro technologies. However, it will soon be followed by a major step with the introduction of a new radio interface (Ericsson, 2019).

5G Technology stands for 5th Generation Mobile technology. 5G mobile technology has changed the means to use cell phones within very high bandwidth. User never experienced ever before such a high value technology. Nowadays mobile users have much awareness of the cell phone (mobile) technology. The 5G technologies include all type of advanced features which makes 5G mobile technology most powerful and in huge demand in near future.

### **2.4.2 Hardware**

- UWB Networks: higher bandwidth at low energy levels.
- Bandwidth: 4000 Mbps, which is 400 times faster than today's wireless networks.
- Smart Antennas: Switched Beam Antennas, Adaptive Array Antennas.
- Multiplexing: CDMA (Code Division Multiple Access).

### **2.4.3 Software**

5G will be single unified standard of different wireless networks, including wireless LAN technologies LAN, WLAN, PAN and WWW (world wide wireless web), unified IP and seamless combination of broadband.

### **2.4.4 Features**

-5G technology offer high resolution for mobile user and large bandwidth shaping.

-The advanced billing interfaces of 5G technology makes it more attractive and effective.

-The advanced billing interfaces of 5G technology makes it more attractive and effective.

-The high quality services of 5G technology based on Policy to avoid error.

-5G technology offer transporter class gateway with unparalleled consistency.

-The 5G technology is providing up to 25 Mbps connectivity speed.

-The 5G technology also support virtual private network.

-The uploading and downloading speed of 5G technology touching the peak.

### **2.4.5 5G Based on Cognitive Radio 5G Concept**

The twenty-one century is surely the “century of speed”, and achieves a high evolution in all the possible domains, especially in communication: a very large variety of services, software, equipment, possibilities etc. But this huge and colored offer also brings a complicated lifestyle and waste of time for the human beings, and needs to be integrated and achievable in a simple manner. Therefore, a new technology started to be delineated, that will provide all the possible applications, by using only one universal device, and interconnecting the already existing communication infrastructures that is the

fifth generation of the mobile communications standards—5G (Toskala ET AL., 2020).

Both the cognitive radio (CR) and the fifth generation of cellular wireless standards (5G) are considered to be the future technologies: on one hand, CR offers the possibility to significantly increase the spectrum efficiency, by smart secondary users (CR users) using the free licensed users spectrum holes; on the other hand, the 5G implies the whole wireless world interconnection (WISDOM—Wireless Innovative System for Dynamic Operating Mega communications concept), together with very high data rates Quality of Service (QoS) service applications. Cognitive Radios (CRs) integrate radio technology and networking technology to provide efficient use of radio spectrum, a natural resource, and advanced user services. The idea of a cognitive radio extends the concepts of a hardware radio and a software defined radio (SDR) from a simple, single a function device to a radio that senses and reacts to its operating environment. A Cognitive Radio incorporates multiple sources of information, determines its current operating settings, and collaborates with other cognitive radios in a wireless network. The promise of cognitive radios is improved use of spectrum resources, reduced engineering and planning time, and adaptation to current operating conditions (Toskala ET AL., 2020).

### **2.4.6 Requirements**

The three fundamental requirements for building 5G wireless networks are (Jonathan, 2015):

- Capabilities for supporting massive capacity and massive connectivity.
- Support for an increasingly diverse set of services, application and user all with Extremely diverging requirements for work and life.
- Flexible and efficient use of all available non-contiguous spectrum for wildly different network deployment scenarios.

## 2.4.7 Characteristics

The main characteristics of 5G NR technology are (Osseiran et al., 2016);

- The technology 5G presents the high resolution for sharp, passionate cell phone every day and give consumers well shape and fast Internet access.
- The 5G technology provides billing limits in advance that the more beautiful and successful of the modern era.
- The 5G technology also allows users of mobile phones, cell phone records for printing operations.
- The 5G technology for large volume data distribution in Gigabit, which also maintains close ties to almost 65,000.
- The technology gives you 5G carrier distribution gateways to unprecedented maximum stability without delay.
- The information from the data transfer technology 5G organize a more accurate and reliable results.
- Using remote control technology to get the consumer can also get a 5G comfort and relax by having a better speed and clarity in less time alone.
- The 5G technology also support virtual private network.
- The uploading and downloading speed of 5G technology touching the peak.
- The 5G technology network offering enhanced and available connectivity just about the world.
- 5G network is very fast and reliable.

## 2.4.8 Applications

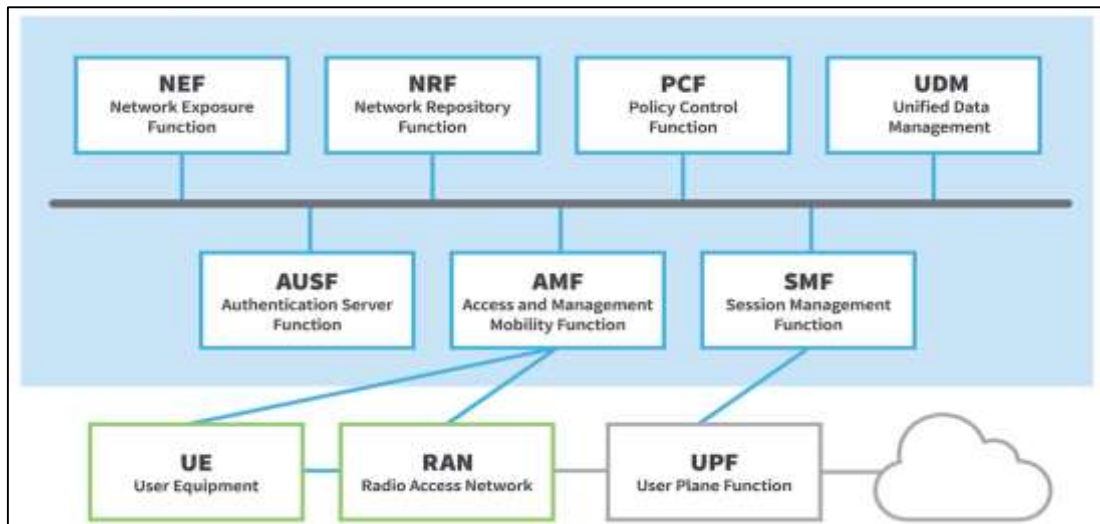
The main applications of 5G NR technology are (Schober et al., 2017);

- 1) Real wireless world with no more limitation with access and zone issues.

- 2) Wearable devices with AI capabilities.
- 3) Internet protocol version 6(IPv6), where a visiting care-of mobile IP address is assigned according to location and connected network.
- 4) One unified global standard.
- 5) Pervasive networks providing ubiquitous computing: The user can simultaneously be connected to several wireless access technologies and seamlessly move between them these access technologies can be a 2.5G,3G, 4G or 5G mobile networks, Wi-Fi, WPAN or any other future access technology. In 5G, the concept may be further developed into multiple concurrent data transfer paths.
- 6) Cognitive radio technology, also known as smart radio: allowing different radio technologies to share the same spectrum efficiently by adaptively finding unused spectrum and adapting the transmission scheme to the requirements of the technologies currently sharing the spectrum. This dynamic radio resource management is achieved in a distributed fashion, and relies on software defined radio.
- 7) High altitude stratospheric platform station (HAPS) Systems. The radio interface of 5G communication systems is suggested in a Korean research and development program to be based on beam division multiple access (BDMA) and group cooperative relay techniques.

### **2.4.9 Architecture**

5G was designed from the ground up, and network functions are split up by service. That is why this architecture is also called 5G core Service-Based Architecture (SBA). The following 5G network topology diagram shows the key components of a 5G core network (Asif, 2018):



**Figure 2. 29:** 5G System Architecture

Here's how it works:

- User Equipment (UE) like 5G smartphones or 5G cellular devices connect over the 5G New Radio Access Network to the 5G core and further to Data Networks (DN), like the Internet.
- The Access and Mobility Management Function (AMF) acts as a single-entry point for the UE connection.
- Based on the service requested by the UE, the AMF selects the respective Session Management Function (SMF) for managing the user session.
- The User Plane Function (UPF) transports the IP data traffic (user plane) between the User Equipment (UE) and the external networks.
- The Authentication Server Function (AUSF) allows the AMF to authenticate the UE and access services of the 5G core.
- Other functions like the Session Management Function (SMF), the Policy Control Function (PCF), the Application Function (AF) and the Unified Data Management (UDM) function provide the policy control framework, applying policy decisions and accessing subscription information, to govern the network behavior.

As you can see, the 5G network architecture is more complex behind the scenes, but this complexity is needed to provide better service that can be tailored to the broad range of 5G use cases.



5G NR core will include three fundamental elements described in the figure below (Al-Dulaimi et al., 2018):



**Figure 2. 30:** The top three cases of 5G uses

- Enhanced Mobile Broadband (eMBB): Including data speeds of several gigabits per second (Gbit/s) for applications such as virtual reality and the ability to support significant growth in data traffic.
- Ultra-reliable and Low-latency Communications (uRLLC) or Mission-Critical Control: for latency-sensitive services requiring extremely high reliability, availability and safety, such as autonomous driving.
- Massive Machine Type Communications (mMTC) or Massive IoT: Offering the ability to support a large number of low-cost IoT connections with a very long battery life and wide coverage, including inside buildings (Erik Guttman).

The RAN based on the New Radio (NR) standard will provide high levels of capacity and peak data rates along with low latency. These networks can provide 10 Mbits/s to 10 of 100 of users at the same time.

#### **2.4.10 Deployments Scenarios**

3GPP introduce the 5G standards in Release 15 to provide guidelines for 5G networks. These standards aim to provide massive throughput and low latency to the end user (Gallardo, 2019).

There are different phases under which 5G NR (New Radio) will be deployed as per 3GPP specifications published in the December 2017 (Gabriel Brown).

phase 1 (Rel-15, 06.18 stage 3 freeze) and phase 2 (Rel-16, 12.19 stage 3 freeze).

5G can be deployed in five different deployment options, where SA (standalone) options consist of only one generation of radio access technology and NSA options consist of four generations of radio access technologies (4G LTE and 5G).

3GPP has defined two solutions for 5G networks as follows (Imane et al., 2020):

#### **2.4.10.1 5G Standalone (SA)**

The 5G Standalone architecture SA will depend on 5G New Radio (5G NR) and 5G Core Network (5GC). New capabilities like Network Slicing using E2E, CUPS, Virtualization, MultiGbps support, and Ultra low latency will be inherently built into the 5G SA Packet Core architecture (Zetao Xu, Yang Zhang, Ao Shen, Bao Guo, Yuehua Han and Yi Liu, 2019).

The salient features of SA implementation are:

- 5G will be used for both C-Plane and U-Plane.
- All radio control parameters will be exchanged through 5G.
- Paging channels will be monitored by UE on 5G.

#### **2.4.10.2 5G Non-Standalone (NSA):**

The Non-Standalone deployment based on the already existing LTE radio access and core network (EPC) as an anchor for mobility management and coverage to add the 5G carrier. This solution will be more cost-efficient and can be provided in a shorter time.

NSA mode is based on EUTRA-NR Dual connectivity (ENDC) where 5G radio will work with 4G-core network and will give hotspot coverage along with the existing 4G network.

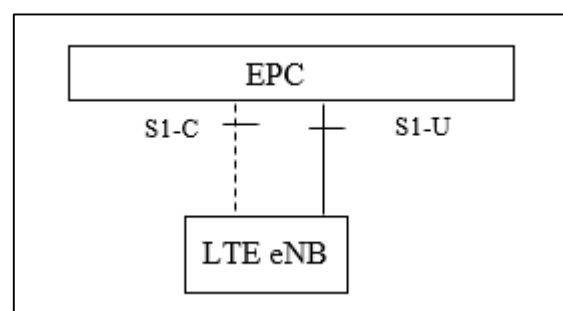
In NSA, 5G will only focus on U-Plane; all the C-plane messages like call origination/termination, location registration, etc. will be handled by the LTE

eNB and EPC (Zetao Xu, Yang Zhang, Ao Shen, Bao Guo, Yuehua Han and Yi Liu, 2019).

#### 2.4.10.3 Option 1: SA LTE under EPC

Option 1 represents current 4G (LTE) deployments. It is also called Standalone LTE or EPC connected system. At present, most operators may have already deployed this option.

The SA option is a simple solution for operators to manage and can be deployed as an independent network using the Handover between 4G and 5G for service continuity.



**Figure 2. 31:** Option 1

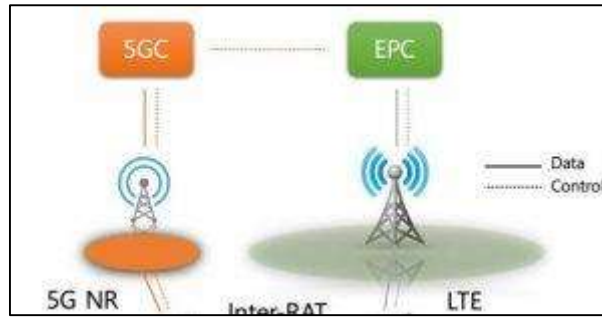
#### 2.4.10.4 Option2: SA NR under 5GC

This deployment scenario will be particularly beneficial in areas where there is no LTE system and where the operator wants to deploy a full-fledged 5G NR access system without 4G interconnection.

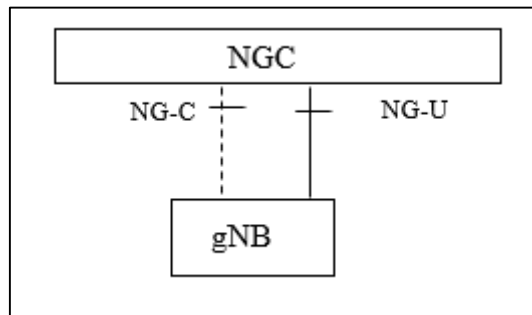
This option allows the operator to implement all types of 5G use cases such as eMBB, mMTC and URLLC.

A prerequisite for this option is that the operator should have multiple spectra so that they can provide ubiquitous 5G coverage and enjoy all the benefits.

Standalone option 2 is where radio access network consists of only gNBs and connects to 5G Core, and the 5GC interworks with EPC. SA option 2 has no impact on LTE radio and can fully support all 5G use cases.



**Figure 2. 32:** High-level 5GC SA Option 2 interworks with EPC



**Figure 2. 33:** Option 2

In SA NR, the gNB connects directly to the 5G core. The SA NR system has been defined in the 5G specifications, for 3GPP Rel-15. The benefits of this option are:

- The operator can fully leverage 5G E2E (End-to-end) capabilities.
- All specifications have been standardized to 3GPP Rel-15 (September-2018)
- The user plan and the control plan are both managed by 5G network.
- The operator can deploy Inter-RAT mobility between LTE/EPC and NR / 5GC.
- The operator can choose between Voice fallback on VoLTE, or IMS Voice on NR (VoNR).

The drawbacks of this approach are:

- Direct deployment of 5G requires more investment.

- The operator cannot take advantage of existing deployments of the existing network (LTE) in the short term.

This phase promises the greatest potential for future evolution and growth, with many new capabilities introduced in 5GC. The devices will also be able to handle many new services.

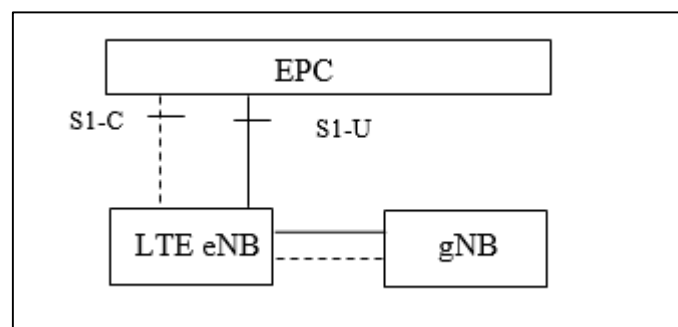
#### 2.4.10.5 Option 3: NSA LTE and NR under EPC

Option 3 is a NSA scenario where the network still use LTE with NR radio access, but using only LTE's EPC core to deliver control signals. In this option, LTE is used as the anchor of the control plan for NR, LTE and NR are used for user data traffic (User Plan).

It could also be called non-Standalone (NSA) NR in Evolved Packet System.

##### 2.4.10.4.1 Option 3

In option 3, ENB is the master that send and receive all Uplink and Downlink data, also decide which part of the data would send to the 4G/5G station using X2 interface. Therefore, 5G gNB does not have any direct communication with LTE core network.

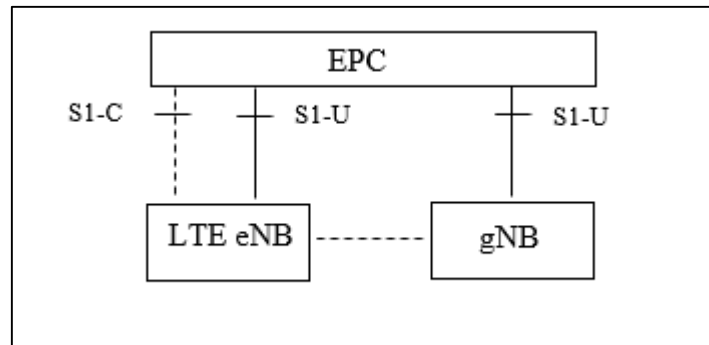


**Figure 2. 34:** Option 3

Hardware upgrade is probably required, because they would be more additional traffic to be handled.

2.5.2 Option 3a This option allowed to 5G gNB and LTE ENB to communicate directly with 4G-core network without having communication

between them over the X2 interface. There is only control plane traffic in the X2 interface. So the X2 traffic is very small.

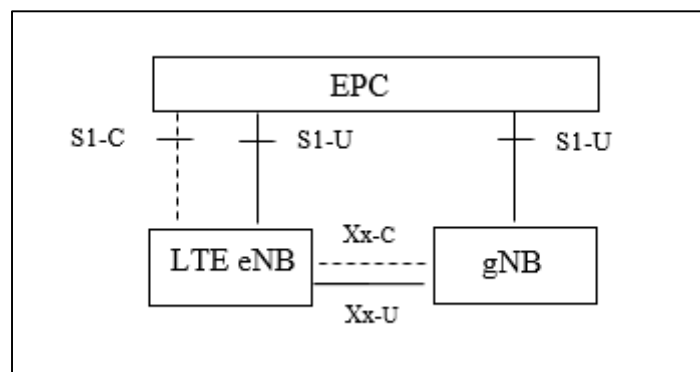


**Figure 2. 35:** Option 3a

This means that there can be no load sharing of data over a single bearer over 4G and 5G. That means, for example, that the 4G part only handles the VoLTE voice traffic for a user while his Internet traffic is only handled by the 5G part of the base station. Say that in most deployment scenarios, this is not really an option if mobile devices move in and out of 5G network coverage continuously.

**2.4.10.4.2 Option 3x**

3x is a combination of 3 and 3a, so both S1 and X2 interfaces are available for User plan so the traffic can be split based on the backhaul capacity of S1-U.



**Figure 2. 36:** Option 3x

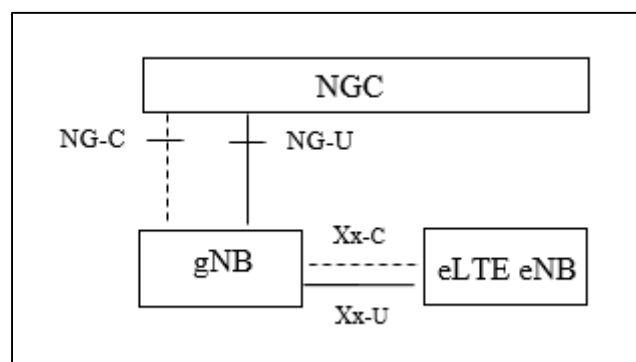
- Option 3x provides robust coverage in higher frequencies and aggregated peak bit rate of LTE and 5G for lower frequencies.
- Option 3x also provides near zero interrupt time LTE-5G mobility.
- Option-3x provides allows voice in LTE without using RAT fallback.
- This configuration can be used in scenarios where LTE coverage reach is superior to that of NR and thus leverages EPC.

#### 2.4.10.6 Option4: NSA NR and LTE under 5GC

With option 4, the gNB act as the master node and eNB is the secondary node, so the NR RAN will be in charge of C-Plan signalization.

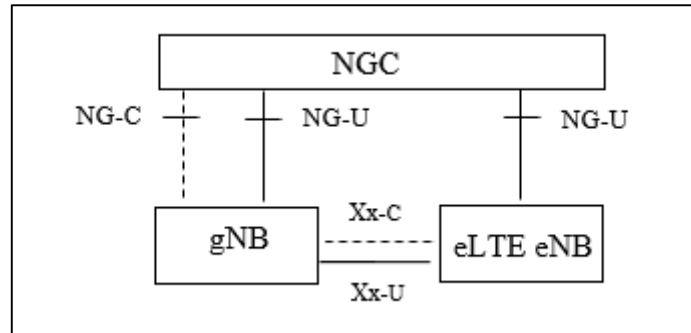
##### 2.4.10.6.1 Option 4

In option 4, there is no direct connectivity between ng-eNB and 5GC. All the information follows via Xn interface that should be newly designed.



**Figure 2. 37:** Option 4

In option 4a, there is no Xn interface between gn-eNB and gNB, gn-eNB is connected to 5GC via NG-U interface. This option also option 4 required an upgrade (release 15) of eLTE and a strong 5G coverage.



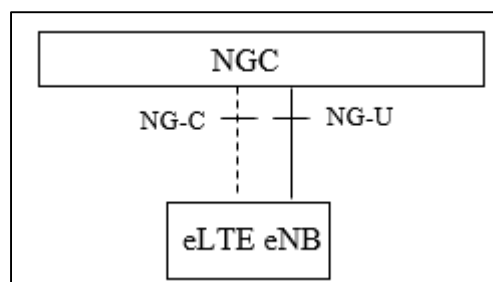
**Figure 2. 38:** Option 4a

**2.4.10.7 Option5: SA LTE under 5GC**

In this option, the network made the transition to the NGC, but continued the use of LTE access. LTE, in this case, is an advanced LTE RAN that includes new signage.

Given that most of the benefits of 5G will come from migrating to a new radio, this option seems unlikely.

Stand Alone (SA) Evolved E-UTRA (LTE) in 5G Standalone (5GS): This deployment scenario is particularly suited to areas that do not have an inherited LTE system and advanced EUTRAN access systems are deployed. In this deployment, the ng-eNB is connected to 5GC.



**Figure 2. 39:** Option 5

One important point to consider here is that it not all of these intermediate options can be practically implemented.



### 2.4.10.8 Option7: NSA LTE and NR under 5GC

The last NSA option is option 7 LTE assisted NR ,instead of using EPC core in option 3, we use 5G core using the Ng interfaces rather than Xx interfaces , and to handle those interfaces the eNodeB must be upgraded to the next generation eNB(ng-eNB) (3GPP release 15 ).

We have three sub-options: 2.8.1 Option 7 In option 7 there is no interfaces between gNB and 5GC the data flows via Xn inter-faces.

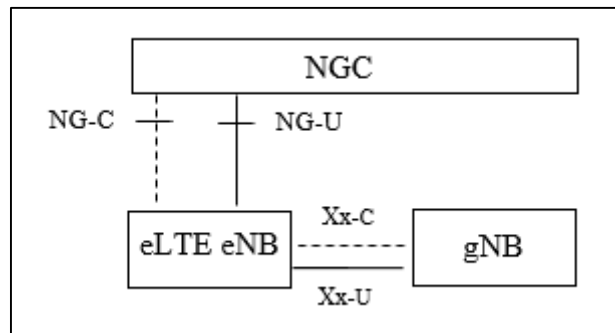


Figure 2. 40: Option 7

#### 2.4.10.8.1 Option 7a

The difference between 7 and 7a is that U-plane data is no longer sent via Xn, but via NG-U, so here appeared the characteristic of NSA option when they use ng-LTE as an anchor to have a connectivity with 5GC.

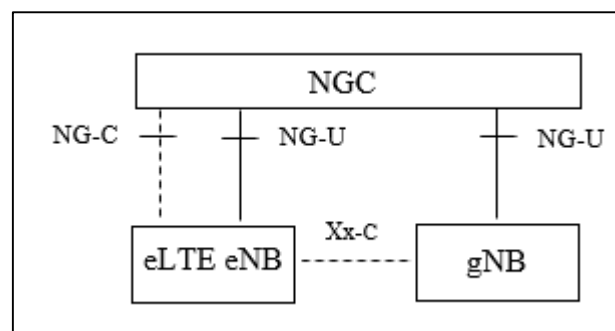


Figure 2. 41: Option 7a

## **2.5 Cellular Planning and Optimization**

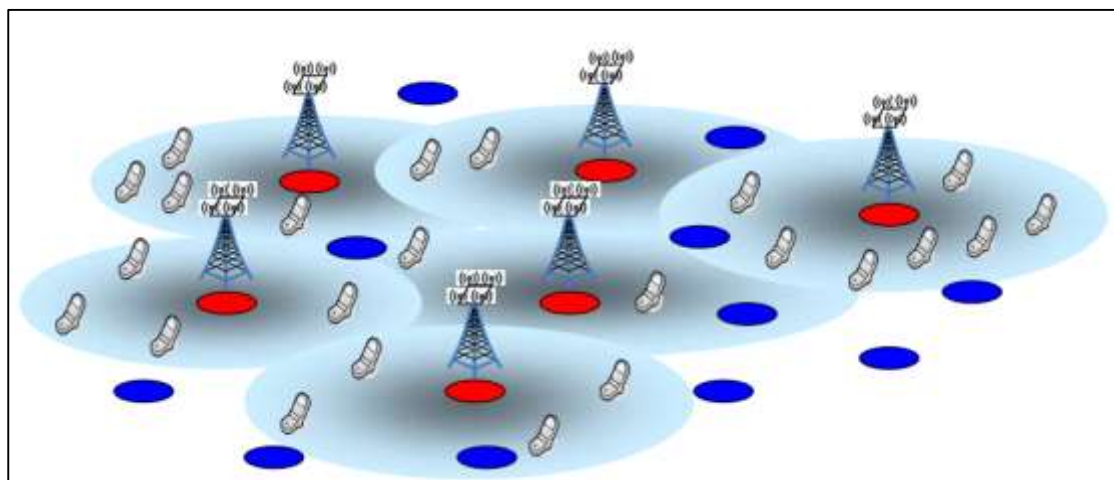
### **2.5.1 Introduction**

Network planning and optimization play a key role in reducing the capital expenditure (CAPEX) and operational expenditure (OPEX) for deploying and expanding cellular systems. Typically, radio network planning begins with a definition and dimensioning stage, which includes traffic estimation, service definition, coverage and capacity requirements, etc. It is traditionally considered as a static process. Some of the main tasks are site selection for base station location, location area and routing area planning, and radio resource management (RRM) strategies. Besides fulfilling the initial requirements such as coverage and capacity, radio resource has to be acquired in a way that the cost is minimized. Optimization is a long-term process before and after the launch of a network. The process applies various methods to maximize the system performance by optimally configuring the network and utilizing its resources. Traditionally, a large amount of manual tuning has been used in the optimization process. Nowadays, advanced optimization tools have been developed to automatically optimize the parameters for maximizing system performance, making the optimization process much more efficient (Chen, 2010).

Analog-based 1G cellular networks did not pose much requirement to planning and optimization. Having low capacity requirement, the key problem is to provide a satisfied degree of coverage. With the success of 2G networks and the increasing amount of voice and data demand, cellular systems have become more and more complex. New radio access technologies also introduce new challenges to the planning and optimization processes. In the following, we outline some representative planning and optimization problems in cellular networks (Chen, 2010).

## 2.5.2 Base Station Location

A very fundamental planning task in cellular networks is the base station (BS) location. To deal with the increasing user demand, more and more base stations are needed to provide satisfactory services. A resulting optimization problem is to determine how many and where base stations should be located in order to meet coverage and capacity requirements. An illustration of the problem is shown in Fig. 2.42. In the figure, the red spots require BS installed while the blue spots do not (Chen, 2010).

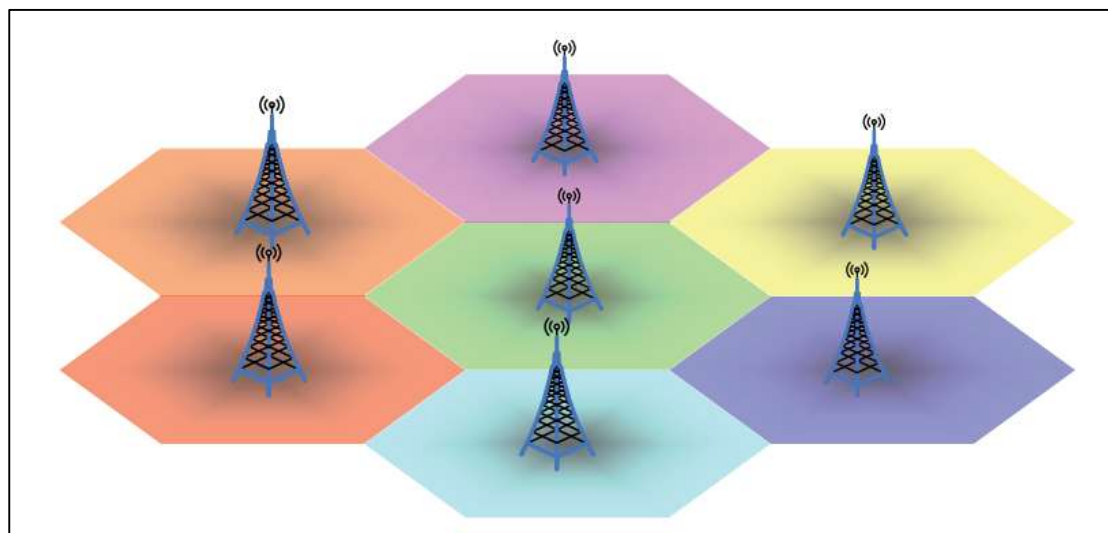


**Figure 2. 42:** An illustration of base station location.

In general, the base station location problem is NP-hard in problem complexity. For 2G networks, to a large extent, the task can be regarded as a type of set covering problem, the performance is mainly coverage-driven and mostly depends on the propagation model. In this case, BSs are located among the candidate locations so that signal strength is high enough for the areas to be covered. For 3G networks with WCDMA, this is however not enough as the single-to-interference ratio (SIR) needs to be taken into account. Besides the location of BS, coverage itself is heavily influenced by the traffic distribution. Thus, BS location in UMTS networks has to consider power control which in its turn is tightly connected to traffic distribution. In the past years, BS location has been extensively studied for both 2G and 3G networks. Both mathematical modeling and heuristic algorithms have been proposed for problem solution (Chen, 2010).

### 2.5.3 Frequency Planning

Along with BS location, another vital issue in 2G GSM networks is to deal with the frequency assignment problem (FAP) . To avoid interference in GSM networks, neighboring cells should use different frequencies, see Fig. 3 for an illustration (Chen, 2010).



**Figure 2. 43:** An illustration of frequency assignment

Due to the high site density and the scarcity of the spectrum resource, frequency allocation has to be carefully planned so that high spectral efficiency and low interference can be achieved. Many optimization methods and algorithms have been proposed for FAP in GSM netw. Planning strategies for more advanced frequency use, such as frequency hopping (FH) and dynamic channel allocation (DCA), have also been proposed. In WCDMA networks, the frequency reuse factor is one, so FAP is not present. For the new radio interface OFDMA adopted in LTE networks, frequency optimization becomes again a key issue. LTE is designed to scale well in the spectrum availability. The spectrum is divided into a large number of subcarriers which are orthogonal to each other. This enables a higher flexibility in respect to resource allocation. With OFDMA, intra-cell interference does not exist because of the orthogonality, but inter-cell interference may become the performance-limiting factor, especially for cell-

edge users with poor radio signal condition. Sub-carrier allocation has to be done carefully to mitigate intercell interference. To this end, fractional frequency reuse (FFR) and soft frequency reuse (SFR) schemes have been proposed. With the evolution from 3G to 4G networks, inter-cell interference mitigation is attracting more and more research attention (Chen, 2010).

#### **2.5.4 Radio Resource Management (RRM)**

RRM is fundamental in cellular networks. Many optimization problems involving allocation strategies of various types of resource appear in RRM. The aforementioned FAP can be regarded as part of RRM, since frequency is a highly valuable resource in cellular networks. Another key resource type is transmission power. Transmission power plays an important role in interference management, energy consumption, as well as service quality. Thus power control (PC) mechanisms have been considered. PC can be located at user equipment (UE), BS, or radio network controller (RNC). It is a key component in IS-95 CDMA systems because of the near-far effect. GSM networks also has PC mechanism, although the need for PC is not as high as IS-95 (Chen, 2010).

For 3G and 4G systems, more advanced PC mechanisms have been explored. Rather than considering a fixed SIR as in 2G systems, the achievable SIR varies, and is usually jointly controlled and optimized in the PC mechanism in 3G systems. Furthermore, PC algorithms also need to closely cooperate with other RRM procedures (e.g. scheduling) to maximize the network performance. Due to the rapid growth of cellular networks, extensive research has been done on PC algorithms with fixed SIR and variable SIR, opportunistic PC, PC based on game theory, joint PC and beamforming, joint PC and BS location, etc (Chen, 2010).

In addition to PC, scheduling is an important component of RRM since packet switching became supported in cellular networks. Scheduling means usually to allocate resource among users along the time dimension, to maximize target metrics (e.g. throughput, quality of service (QoS), fairness,

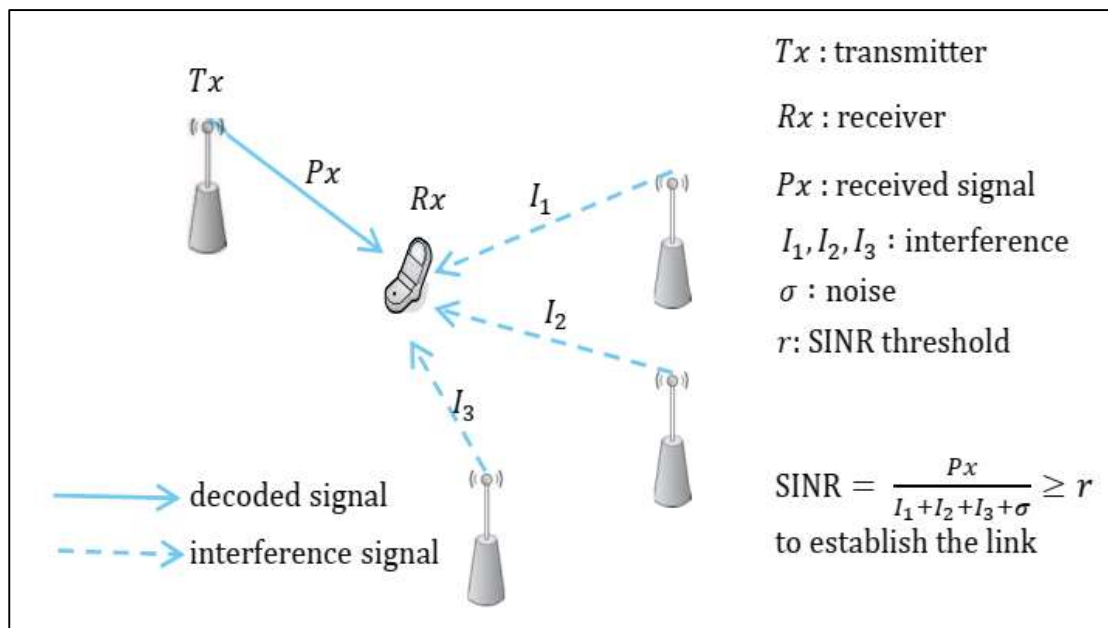
etc). Typical scheduling strategies include round robin (RR), maximum throughput, proportional fair (PF), minimum guaranteed bit rate scheduling (min-GBR), minimum bit rate scheduling with proportional fairness (min-GBR+PF), as well as maximum delay scheduling. For UMTS R99, which is based on a dedicated channel (DCH), scheduling is done at RNC. HSDPA introduces a high speed downlink shared channel (HS-DSCH). Instead of placing the packet scheduler at RNC, HSDPA utilizes a fast scheduler at Node B, giving Node B the ability to rapidly adapt to the channel conditions of the users. Similar to HSDPA, HSUPA introduces an enhanced DCH (E-DCH) for uplink which also supports fast scheduling. At present, HSPA is the most widely used cellular technology for mobile broadband, and a vast amount of literature has been devoted to its scheduling algorithms and RRM strategies (Chen, 2010).

With OFDMA, the flexibility in radio resource allocation grows. The downlink resource grid in LTE consists of resource blocks (RBs), each consists of 12 sub-carriers and 7 OFDM symbols. Depending on the available bandwidth, up to 100 RBs (with a bandwidth of 20 MHz) can be allocated. Power is jointly allocated with RBs. Moreover, information can be transmitted and combined by multiple antennas, which add one more dimension of freedom. Thus resource allocation in LTE involves several dimensions. Because of the flexibility, the performance of scheduling algorithms is crucial in OFDMA based networks. Numerous articles investigated resource allocation strategies for, and more specifically for LTE (Chen, 2010).

Additional functionalities, such as admission control and load control, are also needed in RRM. It is worth mentioning the RRM components are not independent of each other, and the overall performance is a joint effect of the various RRM functionalities (Chen, 2010).

## 2.5.5 Capacity Analysis for Wireless Communications

Wireless communication systems is typically interference limited, where cochannel transmissions are posing interferences to each other. To establish a transmission, the signal-to-interference-and-noise ratio (SINR) at the receiver side should reach a threshold, as illustrated in Fig. 2.1.



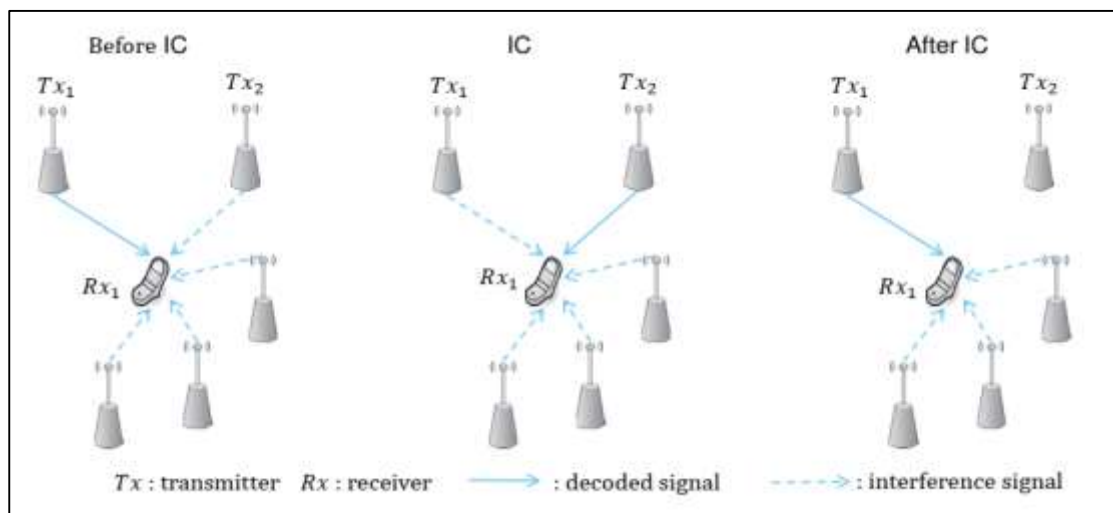
**Figure 2. 44:** An illustration of interference

One of the fundamental optimization problems in wireless network engineering is to find out the maximum number of simultaneous transmissions, subject to the SINR requirement at each receiver, aka maximum link activation (LA). Solving the problem is part of the radio resource management algorithms in wireless communications, such as scheduling, where a set of parallel transmissions need to be selected for a certain time slot. Solving LA involves numerically difficult SINR constraints, thus requiring large amount of computing resources and time. An efficient algorithm which can deliver the global optimal is highly desired (Chen, 2010).

Another aspect of capacity analysis is the introduction of advanced receivers with interference cancellation (IC) capability, such as in LTE-Advanced. IC allows the receiver to cancel interference from certain transmitters (usually

strong interfering transmitters) if the receiver can decode the interference signal. Successful cancellation will remove the canceled interference from the total received interference, therefore, decoding the interested signal becomes easier. This potentially can activate a transmission which cannot be established without IC, or achieve a better SINR, thus higher transmission rate, for links which can be established but having poor signal condition. The concept of IC is shown in Fig. 2.2 where Rx1 cancels the interference from Tx2 before decoding the signal from Tx1 (Chen, 2010).

IC brings benefits and challenges. LA with IC (LA-IC) involves solving both the SINR constraints for each receiver, as well as similar conditions for determining whether IC can be enabled. This adds extra difficulties in solving the problem. With the fast deployment of LTE networks and the rapid standardization of LTE-A, it can be foreseen that future hand devices will mostly have IC enabled. Therefore, solving LA-IC not only gives insight for the capacity of future networks, but also provides methods to further explore the spectral efficiency (Chen, 2010).



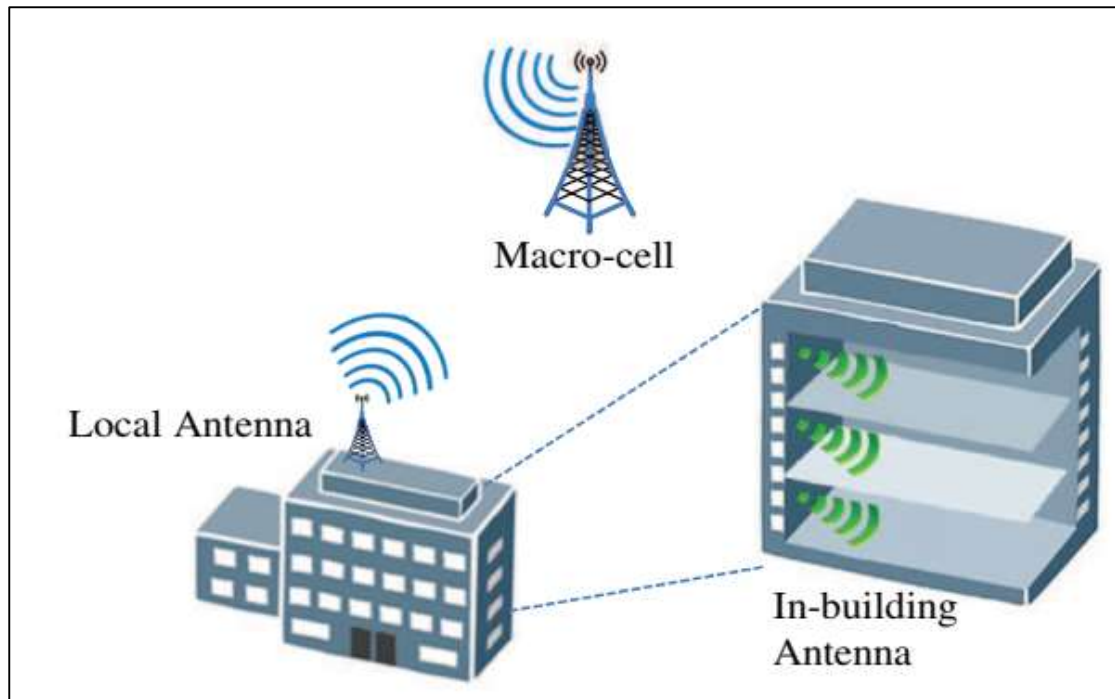
**Figure 2. 45:** Illustration of interference cancellation



### **2.5.6 In-building Solutions**

Along with the mobile data explosion, the mobile traffic distribution has shown a very uneven trend. More than 70% of the total traffic has been generated by in-building users, necessitating an efficient in-building solution. In-building environment is naturally unfavorable for signal transmission because of the signal loss for wall penetration and multi-path propagation. The in-building users who are served by conventional macro-cells usually have low signal quality, resulting in poor user experiences. Typically, wall penetration brings 20-25 dB power loss, resulting in either poor in-building coverage, or high transmit power at the base station and the user equipment. Wi-Fi access has long been used by home users for wireless connection. It has been considered in the heterogeneous network architecture as an integral part, where it is expected to be able to connect to the mobile broadband core network in the future. Femto-cells, aka home eNodeBs, are small radio cells connected to the mobile broadband core network, and usually cover a very small area for home and office users. The current deployment of Wi-Fi and Femto-cells, in most of the cases, are customer based, although it can also be deployed by operators. Therefore, the operators have little control of the deployment, thus cross-tier interference is a potential problem (Mishra, 2007).

Another systematic solution for medium to large sized buildings is to use in-building distributed antenna system (IB-DAS). Instead of using macro-cells, IB-DAS deploys a number of in-building antennas for coverage. In-building antennas are preferably serving the users via a line-of-sight transmission, thus a much better propagation condition can be achieved (Mishra, 2007).



**Figure 2. 46: In-Building Distributed Antenna Systems**

Deploying IB-DAS involves connecting all the in-building antennas to the roof antenna which is then connected to the macro-cell via radio links, as illustrated in Fig. 2.5. The indoor connections are mostly done with coaxial cable and power equipment such as power splitters. The locations for in-building antennas and their power levels are pre-calculated according to the coverage planning and capacity requirements. Then, IB-DAS planning is performed to connect the in-building antennas to the roof antenna with minimum cost, where the cost is dominated by the cable usage. Successful deployment of IB-DAS can, to a large extent, avoid coverage holes, help reduce the power consumption and deliver excellent user experiences for in-building subscribers (Mishra, 2007).

## 2.6 Related Works

This part presents some related works that are connected directly or remotely to the current study.

### **2.6.1 Krause et al. (2021)**

**Title: "Network Planning and Coverage Optimization for Mobile Campus Networks"**

The campus networks specified in 5G offer usecase tailored wireless communications that fulfills the demanding requirements of Industry 4.0 applications. Also agriculture and construction sites are fields of application that can benefit from the deployment of such networks. However, permanently installed campus networks do not match their requirements, as the network is needed only for certain time intervals and furthermore needs to be easily adaptable due to the time-varying nature of construction sites. Mobile campus networks (MCNs) solve this problem, as they can be deployed by a trailer in a short time and can be adjusted flexibly. Such MCNs require a very short and as much as possible automated planning and deployment procedure. Thus, conventional radio network planning (RNP) as it is applied for macro cells is too costly and time consuming, as it requires lots of manual effort and is not easily scalable. This paper presents an automated RNP framework for MCN based on MATLAB and WinProp, which optimizes the downlink coverage with one base station for several receiver heights that are relevant in an agricultural scenario. The proposed procedure also includes field measurements, which are intended to be executed by a drone. This allows a high flexibility in the selection of the measurement positions. An algorithm is developed that automates the environment-specific selection of measurement points and thus allows an efficient tuning of the propagation model. Subsequently, based on the measurements the propagation model is tuned and then used to recheck the results of the initial RNP. By applying another propagation model, real-world data are mimicked and the proposed algorithm is evaluated. Index Terms— Mobile Campus Networks, Non-Public Networks, Radio Network Planning, Model Tuning, Dominant Path Mode.

### **2.6.2 Ramos (2019)**

**Title: "Cellular Planning and Optimization for 4G and 5G Mobile Networks"**

Cellular planning and optimization of mobile heterogeneous networks has been a topic of study for several decades with a diversity of resources, such as analytical formulations and simulation software being employed to characterize different scenarios with the aim of improving system capacity. Furthermore, the world has now witnessed the birth of the first commercial 5G New Radio networks with a technology that was developed to ensure the delivery of much higher data rates with comparably lower levels of latency. In the challenging scenarios of 4G and beyond, Carrier Aggregation has been proposed as a resource to allow enhancements in coverage and capacity. Another key element to ensure the success of 4G and 5G networks is the deployment of Small Cells to offload Macrocells. In this context, this MSc dissertation explores Small Cells deployment via an analytical formulation, where metrics such as Carrier plus Noise Interference Ratio, and physical and supported throughput are computed to evaluate the system's capacity under different configurations regarding interferers positioning in a scenario where Spectrum Sharing is explored as a solution to deal with the scarcity of spectrum. One also uses the results of this analyses to propose a cost/revenue optimization where deployment costs are estimated and evaluated as well as the revenue considering the supported throughput obtained for the three frequency bands studied, i.e., 2.6 GHz, 3.5 GHz and 5.62 GHz. Results show that, for a project life time of 5 years, and prices for the traffic of order of 5€ per 1 GB, the system is profitable for all three frequency bands, for distances up to 1335 m. Carrier Aggregation is also investigated, in a scenario where the LTE-Sim packet level simulator is used to evaluate the use of this approach while considering the use of two frequency bands i.e., 2.6 GHz and 800 MHz to perform the aggregation with the scheduling of packets being performed via an integrated common radio resource management used to compute Packet Loss Ratio, delay and goodput under different scenarios of number of users and cell radius. Results of this analysis have been compared to a scenario without Carrier Aggregation and it has been demonstrated that CA is able to enhance capacity by reducing the levels of Packet Loss Ratio and delay, which in turn increases the achievable goodput.

### **2.6.3 Ferrer (2021)**

**Title: "Network Deployment studies in 5G using ATOLL radio planning tool"**

This thesis is intended to study the deployment of 5G NR in different scenarios or cases using the professional radio planning tool called Atoll. The first case is to improve an existing LTE network in a region of Barcelona by placing it a 5G NR network on top that will improve the performance of the first. In the second case study, it is intended to cover the same region using a 4G/5G network at the same time as carrying out a coverage of a mass concert taking place in a small area of the region. The results in terms of users rejected by the network have been very satisfactory and in terms of capacity per user have been mostly satisfactory except in two specific services. In the conclusion, these results are discussed, the limitations of this work are explained and lines of future development are proposed.

### **2.6.4 Bondarenko et al. (2019)**

**Title: "Optimization model for 5G network planning"**

The transition to 5th generation communication standards is not an instantaneous process. It requires careful preparation and preliminary planning. It is necessary to update both the data transmission network and the subscriber radio access network, and since the transition process will be carried out within the network serving subscribers, it is necessary to develop an approach allowing to make network resource updates invisible for customers and with minimal costs for mobile operators. This paper discusses the network planning optimization model of 5th generation wireless technologies formulated as a MILP task.

### **2.6.5 Ghazzai et al. (2015)**

**Title: "Optimized LTE cell planning with varying spatial and temporal user densities"**

Base station (BS) deployment in cellular networks is one of the fundamental problems in network design. This paper proposes a novel method for the cell planning problem for fourth-generation (4G) cellular networks using metaheuristic algorithms. In this approach, we aim to satisfy both cell coverage and capacity constraints simultaneously by formulating an optimization problem that captures practical planning aspects. The starting point of the planning process is defined through a dimensioning exercise that captures both coverage and capacity constraints. Afterward, we implement a metaheuristic algorithm based on swarm intelligence (e.g., particle swarm optimization or the recently proposed gray-wolf optimizer) to find suboptimal BS locations that satisfy both problem constraints in the area of interest, which can be divided into several subareas with different spatial user densities. Subsequently, an iterative approach is executed to eliminate eventual redundant BSs. We also perform Monte Carlo simulations to study the performance of the proposed scheme and compute the average number of users in outage. Next, the problems of green planning with regard to temporal traffic variation and planning with location constraints due to tight limits on electromagnetic radiations are addressed, using the proposed method. Finally, in our simulation results, we apply our proposed approach for different scenarios with different subareas and user distributions and show that the desired network quality-of-service (QoS) targets are always reached, even for large-scale problems.

### **2.6.6 Wang & Ran (2016)**

**Title: "Rethinking cellular network planning and optimization"**

To meet the ever increasing demand of wireless services for high data rates and mobility, mobile communication systems have evolved from the first generation cellular network to the current 4G one. The core purpose of a cellular network is to provide users with guaranteed QoS and seamless

coverage throughout the service area. In the early stage, this task is achieved by installing cells at candidate sites and configuring their parameters as optimally as possible. Generally, each cell is assigned a dedicated operating frequency, and its adjacent cells operate on different frequencies to avoid inter-cell interference. As the evolution of the cellular network proceeds, advanced signal processing techniques, such as coordinated multipoint transmission and reception, and inter-cell interference coordination, are rising as promising solutions to improve the system performance, which on the other hand inevitably increase the CAPEX and OPEX of the cellular system. Besides, as the deployment of cells becomes denser and denser, it is more and more difficult and expensive to obtain capacity or QoS gains with these signal processing techniques. In this article, we rethink the cellular network planning issue in the context of heterogeneous networking, which is widely accepted as a cost-efficient paradigm to enhance the performance of the cellular system. We point out that the essential objectives of designing a cellular network, coverage and capacity, can also be achieved in heterogeneous networking scenarios using a cutting-edge territory division technique, which divides a service region into multiple subregions with almost equal traffic loads. We develop a dynamic cellular network planning framework that can significantly reduce the CAPEX and OPEX of the system. The QoS for users can also be enhanced while shifting away from employing complex and costly signal processing techniques.

#### **2.6.7 Pérez-Romero (2016)**

**Title: "Knowledge-based 5G radio access network planning and optimization. In 2016 International Symposium on Wireless Communication Systems (ISWCS)"**

Self-Organizing Network (SON) functionalities in forthcoming 5G systems stand as a promising field for the fertilization of Artificial Intelligence (AI) mechanisms. In this respect, this paper analyzes how SON functionalities for radio access network planning and optimization in future 5G systems can be built upon AI concepts. A framework is presented that processes input data

from multiple sources and extracts, through learning-based classification, prediction and clustering models, relevant knowledge to drive the decisions made by 5G SON functionalities. Different candidate AI-based tools for knowledge discovery are identified together with the associated knowledge models that can be extracted. On this basis, the applicability of these models to a comprehensive range of 5G SON functions across the categories of self-planning, self-optimization and self-healing is analyzed. Finally, the paper identifies the research directions deriving from the proposed framework.



# **CHAPTER THREE**

# **METHODOLOGY**

# CHAPTER 3

## METHODOLOGY

### 3.1 Introduction

This chapter presents the methodology of the study which depended on discussing the specifications of each technology, then it presents the cited requirements and parameters of each technology, then it presented the initial settings and results, and finally it presents the steps of optimization process.

### 3.2 The Software

#### 3.2.1 Forsk

Forsk is an independent company providing radio planning and optimization software solutions to the wireless industry since 1987 (Atoll User Manual for Radio Networks).

In 1997, Forsk released the first version of Atoll, its flagship radio planning software. Since then, Atoll has evolved to become a comprehensive radio planning and optimization platform and, with more than 7000 installed licenses worldwide, has reached the leading position on the global market. Atoll combines engineering and automation functions that enable operators to smoothly and gradually implement SON processes within their organization (Atoll User Manual for Radio Networks).

Today, Forsk is a global supplier with over 450 customers in 120 countries and strategic partnerships with major players in the industry. Forsk

distributes and supports Atoll directly from offices and technical support centers in France, USA, and China as well as through a worldwide network of distributors and partners (Atoll User Manual for Radio Networks).

Since the first release of Atoll, Forsk has been known for its capability to deliver tailored and turn-key radio planning and optimization environments based on Atoll (Atoll User Manual for Radio Networks).

To help operators streamline their radio planning and optimization processes, Forsk provides a complete range of implementation services, including integration with existing IT infrastructure, automation, as well as data migration, installation, and training services (Atoll User Manual for Radio Networks).

### **3.2.2 Atoll Software**

Forsk is an independent company providing radio planning and optimization software solutions to the wireless industry since 1987 (Atoll User Manual for Radio Networks).

In 1997, Forsk released the first version of Atoll, its flagship radio planning software. Since then, Atoll has evolved to become a comprehensive radio planning and optimization platform and, with more than 7000 installed licenses worldwide, has reached the leading position on the global market. Atoll combines engineering and automation functions that enable operators to smoothly and gradually implement SON processes within their organization (Atoll User Manual for Radio Networks).

Today, Forsk is a global supplier with over 450 customers in 120 countries and strategic partnerships with major players in the industry. Forsk distributes and supports Atoll directly from offices and technical support centers in France, USA, and China as well as through a worldwide network of distributors and partners (Atoll User Manual for Radio Networks).

Since the first release of Atoll, Forsk has been known for its capability to deliver tailored and turn-key radio planning and optimization environments based on Atoll (Atoll User Manual for Radio Networks).

To help operators streamline their radio planning and optimization processes, Forsk provides a complete range of implementation services, including integration with existing IT infrastructure, automation, as well as data migration, installation, and training services (Atoll User Manual for Radio Networks).

## **3.2 Specifications of the Design**

This part discusses the specifications of the design. Those specifications are related to; the location of the study that has been chosen to conduct this study on, the area size, the cell size followed by the total number of cells and the users density. Those specifications of the current study are preceded by quotations from different references that have been approved and published in well-known scientific journals and conferences, and they are cited in the references part at the end of this document. These quotations embody a justification of the specifications chosen to conduct this study (Atoll User Manual for Radio Networks).

### **3.2.1 LTE**

This part discusses the specifications that has been chosen to conduct the study concerning the design of LTE technology.

#### **3.2.1.1 Location of Study**

The location that has been chosen to conduct the study is an area located in the province of Sana'a, Yemen. This area is in the northern part of Sana'a province. It is basically the area where Sana'a Community College is located, and it is expanded to in all directions to cover a larger area surrounding the college. This college is where the researchers of this study have studied for their bachelor degree. This area is currently urban, and can be considered as a sub-urban area in some parts of it. This is not shown well on the aerial photos used in the software because the researchers could not get updated aerial photos of the area that has been populated rapidly in the late few years.

The area of the study is shown in the following figure, and it is surrounded by three layers that are supported by Atoll software. Those layers are;

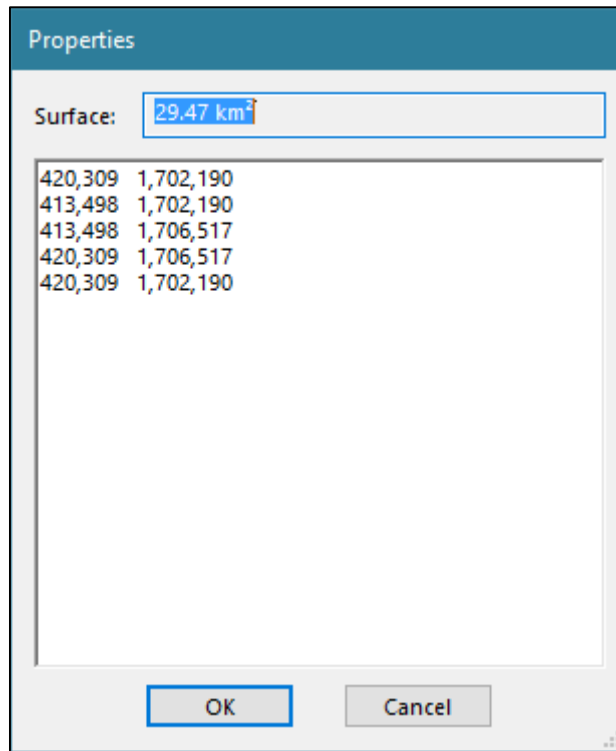
filtering zone in the blue color, computation zone in the line and focusing zone in the green color.



**Figure 3. 1:** Location of the study within 3 layers of Atoll

### **3.2.1.2 Area Size**

As mentioned previously that the area of the study is specified within 3 layers that are supported by Atoll software. Those layers are; filtering zone in the blue color, computation zone in the line and focusing zone in the green color. Since the computation zone is where actual calculations are done, then it will be considered as the actual area of the study and this area has a size of 29.47 km<sup>2</sup>. The size of computation zone and its coordination on the map are shown in the following figure;



**Figure 3. 2:** The size of computation zone and its coordination

### 3.2.1.3 Sites Distribution

As a conservative scenario the Government regulator defining the EMC conditions for such cases chooses the separation distance of 10 km. The limits for LTE-800 base station cell radius are defined by the commercial operators of LTE-800 based on the marketing and commercial factors and they proposed to use the value of 1 km (Galinina et al., 2017).

According to (Moray Rumney, 2013), There is a tradeoff between the cell size and the detection effort of the 64 PRACH preambles. The following table shows the relation between effort, cell radius, the number of root sequences, and the number of cyclic shifts per root sequence.

**Table 3. 1:** PRACH detection effort vs. cell radius

Cell radius (Km)	Number of PRACH preambles and detection effort in %	No. of cyclic shifts per root preamble
0–1.875 km	1—100%	64
1.875–3.75 km	2—200%	32
3.75–7.5 km	4—400%	16
7.5–15 km	8—800%	8
15–30 km	16—1600%	4
30–60 km	32—3200%	2
> 60 km	64—6400%	1

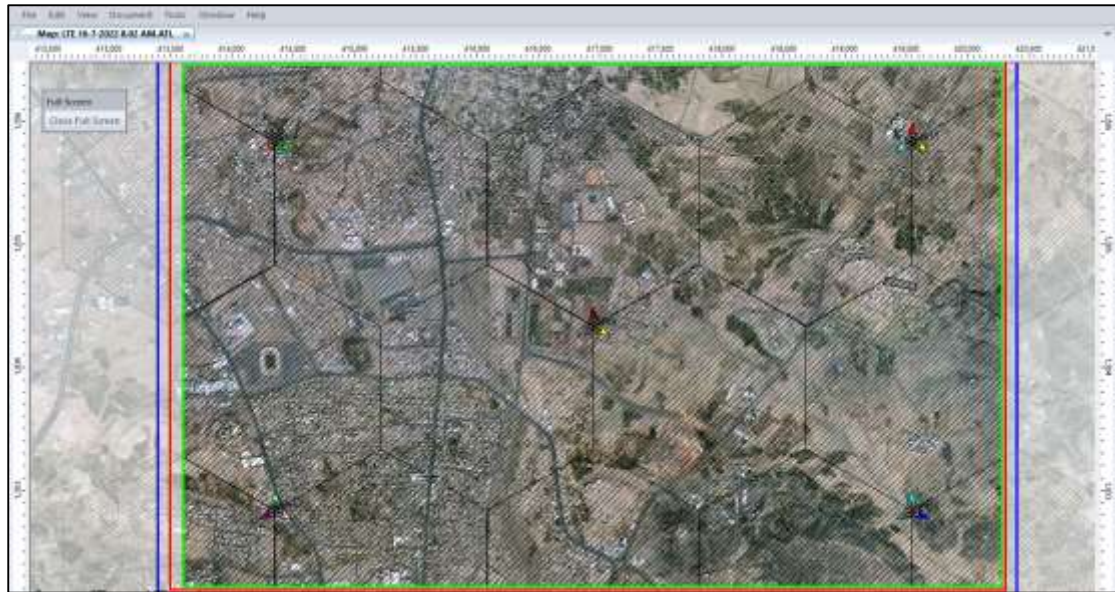
When the cell radius is smaller than 1.875 km, only one single root sequence is needed within 64 possible cyclic shifts to achieve the lowest PRACH detection effort (Moray Rumney, 2013).

According to (Mazzarese et al., 2019), In the LTE-TDD system, two phase accuracy granularities are specified, 1.5 and 5 ns, corresponding to two cell radius sizes differentiated by 3 km. the following table presents a summary of the synchronization requirements of different mobile network modes.

**Table 3. 2:** Mobile technologies Frequency accuracy and cell radius

Radio access technology	Synchronization requirements	
	Frequency accuracy (ppb)	Phase accuracy
GSM, UMTS, WCDMA, LTE-FDD	50	NA
CDMA2000	50	$\pm 3$ to $\pm 10 \mu\text{s}$
TD-SCDMA	50	$\pm 3 \mu\text{s}$
LTE-TDD	50	$\pm 1.5 \mu\text{s}$ (for cell radius $\leq 3$ km)
	50	$\pm 5 \mu\text{s}$ (for cell radius $> 3$ km)
5G-NR	50	$\pm 1.5 \mu\text{s}$

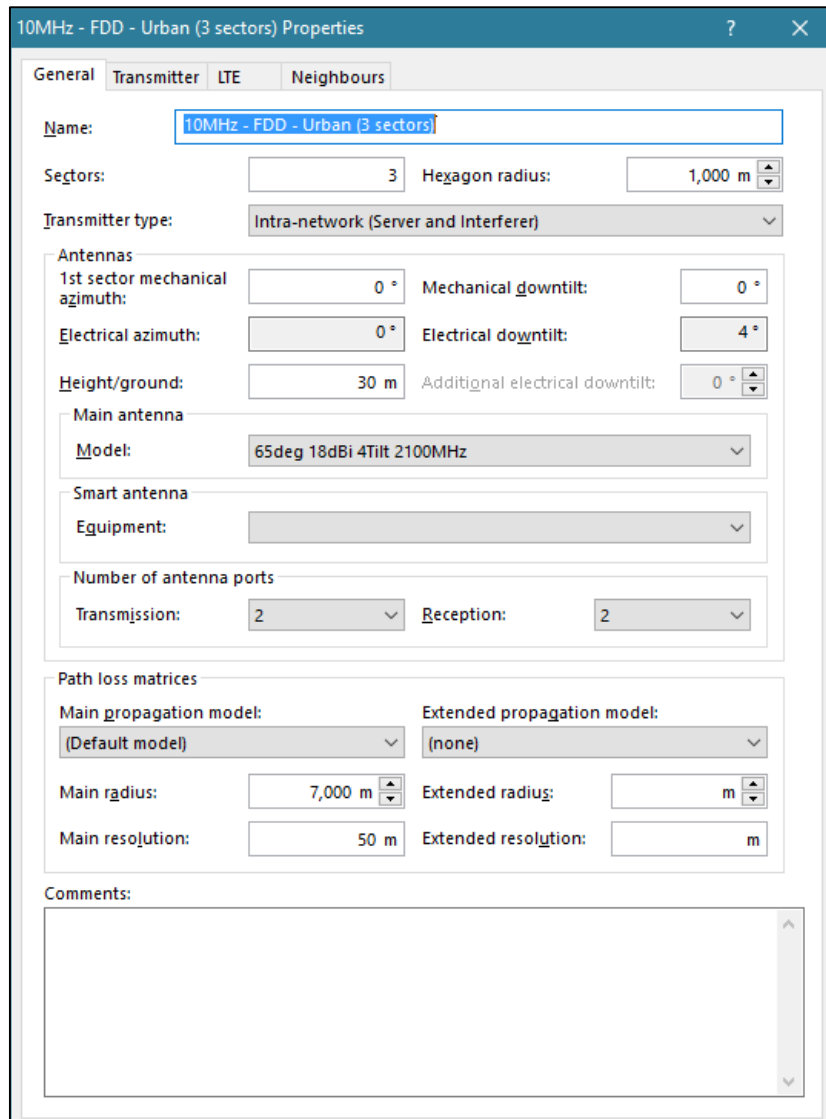
According to all information previously mentioned, a base station template named (10MHz - FDD - Urban (3 sectors)) with a hexagon radius of 1,000m was chosen for this study; therefore, there were 5 sites created within the studied area.



**Figure 3. 3:** Distribution of the 5 sites

The hexagon radius and other specifications of this base station template are as shown in the following figure;





**Figure 3. 4:** specifications of base station template of LTE technology

Using a hexagon radius of 1,000m we get a site-to-site distance of 3,000m. We get this result according to the following formula;

$$R_{\text{site}} = \sqrt{3} \times R_{\text{sector}}$$

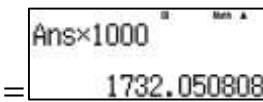
$$DISTANCE_{\text{site-to-site}} = 3 \times R_{\text{sector}} = \sqrt{3} \times R_{\text{site}}$$

**Figure 3. 5:** Site radius and site-to-site formulas

Where;

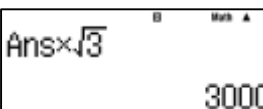
R= Radius of the site or the sector.

Therefore, we can calculate it in the following way;

$$\sqrt{3} \times 1000$$


A calculator screenshot showing the calculation of  $\sqrt{3} \times 1000$ . The display shows "Ans×1000" and the result "1732.050808".

And since we have 3 sectors in each site we multiply this result by  $\sqrt{3}$



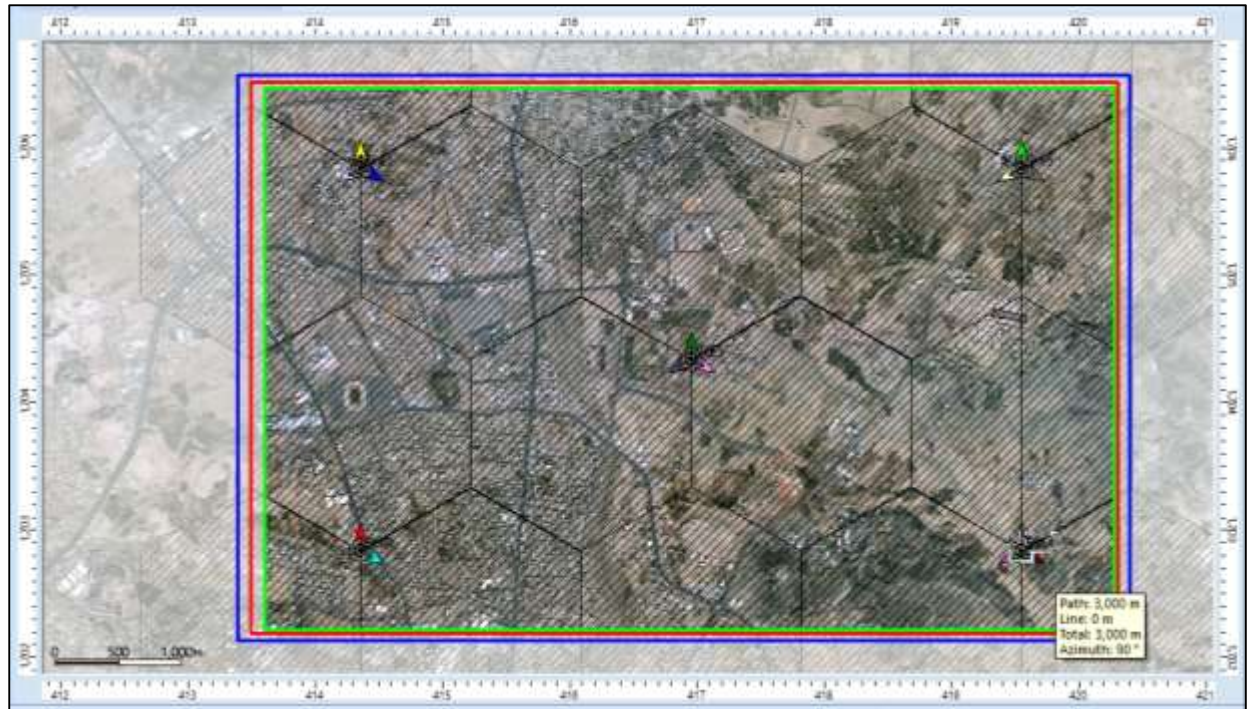
A calculator screenshot showing the calculation of  $1732.050808 \times \sqrt{3}$ . The display shows "Ans×√3" and the result "3000".

So the site-to-site distance = 3,000m, and using the hexagon radius feature within Atoll software we can get this result automatically, and in the following figure It is noticed that there is that the algorithm of Atoll has given us a similar result to the one that has been found using the formula.



**Figure 3. 6:** site-to-site distance from site 1 to site 3

The site-to-site distance is 3,000 from any site to another in the first tire. This can be noticed in another example in the following figure;



**Figure 3. 7:** site-to-site distance from site 4 to site 5

### 3.2.1.4 Users Density

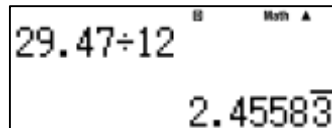
Thanks to the flexible resource allocation in time, frequency and space, and the scalable bandwidths supported by LTE, it is expected that at least 200 users per cell should be supported in the active state for a bandwidth of up to 5 MHz and at least 400 users for higher bandwidths. More users are expected to be supported in a passive (sleeping) state (Timmers et al., 2011).

Also, according to (Kasch et al., 2013), Capacity of LTE is increased to include at least 200 active users per cell in 5 MHz channel bandwidth and at least 400 active users in larger channel bandwidths.

LTE allows multi-antenna applications for single and multi users through MIMO technology (up to 4-layers in the downlink and 2-layers in the uplink), and supports different modulation and coding schemes. Automatic repeat request (ARQ) and hybrid-ARQ are implemented for increased robustness in data transmission. Enhanced mobility support, efficient multimedia broadcast multicast service, QoS provision, security, and cell

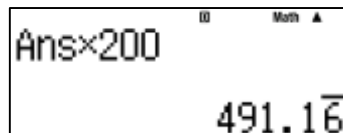
capacity up to 200 active users summarize the key features provided by LTE systems (Adibi, 2015).

According to all information previously mentioned, the user density is specified by 200 active users per cell, and since we have an area of 29.47 km<sup>2</sup> and this area has approximately 12 cells deployed on it, then divide the size of area in km by the number of the cells which is 12.



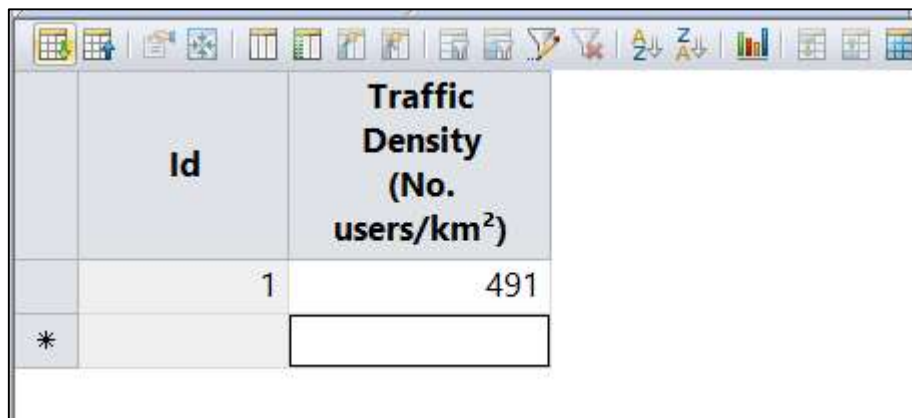
A screenshot of a calculator showing the calculation  $29.47 \div 12 = 2.4558\bar{3}$ . The display shows the result with a repeating decimal bar over the 3.

That means each cell covers approximately 2.456km<sup>2</sup>, then we multiply this value by 200 which is the number of active users per cell.



A screenshot of a calculator showing the calculation  $\text{Ans} \times 200 = 491.1\bar{6}$ . The display shows the result with a repeating decimal bar over the 6.

That means we set the user density value in Atoll software to be 491 user per km<sup>2</sup>. This value is shown in the following figure;



A screenshot of the Atoll software interface showing a table with the following data:

	Id	Traffic Density (No. users/km <sup>2</sup> )
	1	491
*		

**Figure 3. 8:** Users density value per km<sup>2</sup>

### 3.2.2 5G NR

This part discusses the specifications that has been chosen to conduct the study concerning the design of 5G NR technology.

### **3.2.2.1 Location of Study**

Since the current study is a comparative study that aims to understand the differences between LTE and 5G NR technologies in terms of planning and optimization, then the location that has been chosen to conduct this study in regard to 5G NR technology is the same location that has been chosen previously in the LTE part. The full description of the is mentioned in 3.2.1.1, and you can go back to check it.

### **3.2.2.2 Area Size**

Since the current study is a comparative study that aims to understand the differences between LTE and 5G NR technologies in terms of planning and optimization, then the area size that has been specified to conduct this study in regard to 5G NR technology is the same area size that has been specified previously in the LTE part. The full description of the is mentioned in 3.2.1.2, and you can go back to check it.

### **3.2.2.3 Sites Distribution**

On the other hand, the 5G mmWave systems are targeted to be deployed in the following environments: Urban micro with cell radius less than 100 m; Suburban micro with cell radius around 200 m, and access points mounted at 6 to 8 m; and finally, indoor hotspots (offices, cubicles and shopping malls) which are three to five storeys high, and access points spaced at 2 to 3 m (Farhaoui & Moussaid, 2019).

5G networks are widely operated in micro-cells with limited supply radius about 150m. This means a big advantage for use in urban areas with higher user density. The ‘hot-spots’ should be supported. Such 5G microcells can be placed on lanterns, light gas columns or house walls and roofs for sparing of the CAPEX. As deployment examples in micro-cells the festivals, stadiums,

event centers and concert halls, theatres, culture sites and institutions can be mentioned (Gütter & Luntovskyy, 2022).

Millimeter-wave goes through different severe losses such as penetration, rain attenuation, and even foliage. This limits distance coverage requirement in 5G-based cellular mobile deployment. Moreover, path loss is proportional to the frequency squared. It supports about 200-300 m in outdoors based on channel conditions and RS antenna height above the ground (Aksoy, 2020).

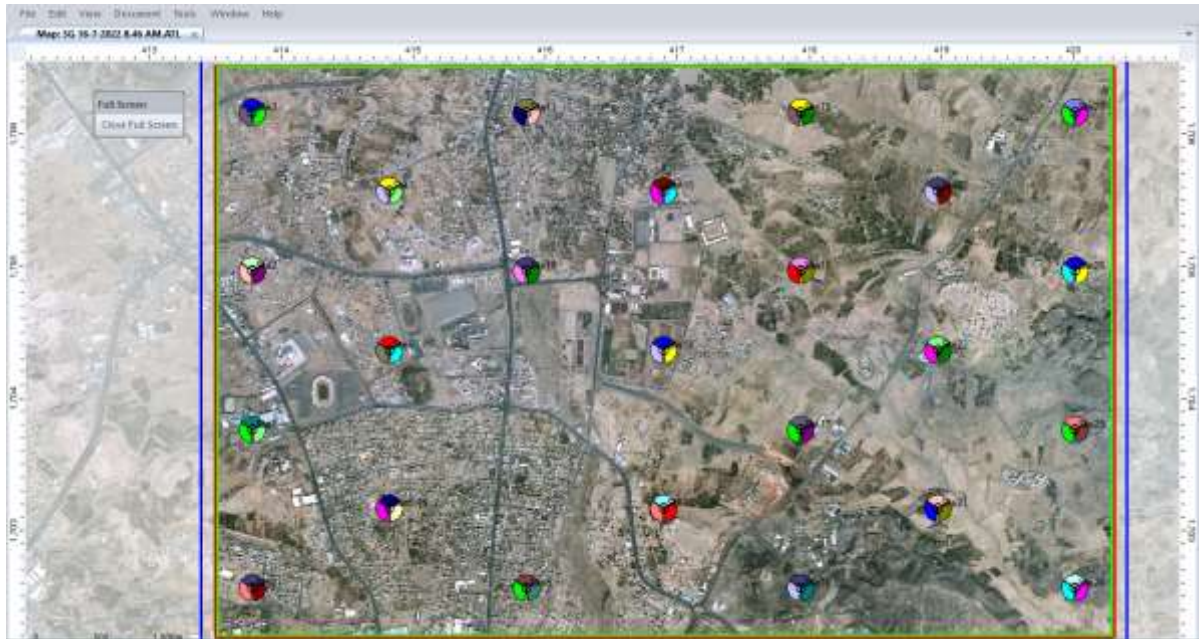
Small cells can be classified as microcells, picocells, or femtocells. These types of cells are differentiated by output power, cell radius, number of users, and Distributed Antenna Systems (DAS) integration (Lynn et al., 2020).

According to (Khan et al., 2020), The following table shows the specifications of the different cells included in 5G NR technology.

**Table 3. 3:** 5G cells specifications

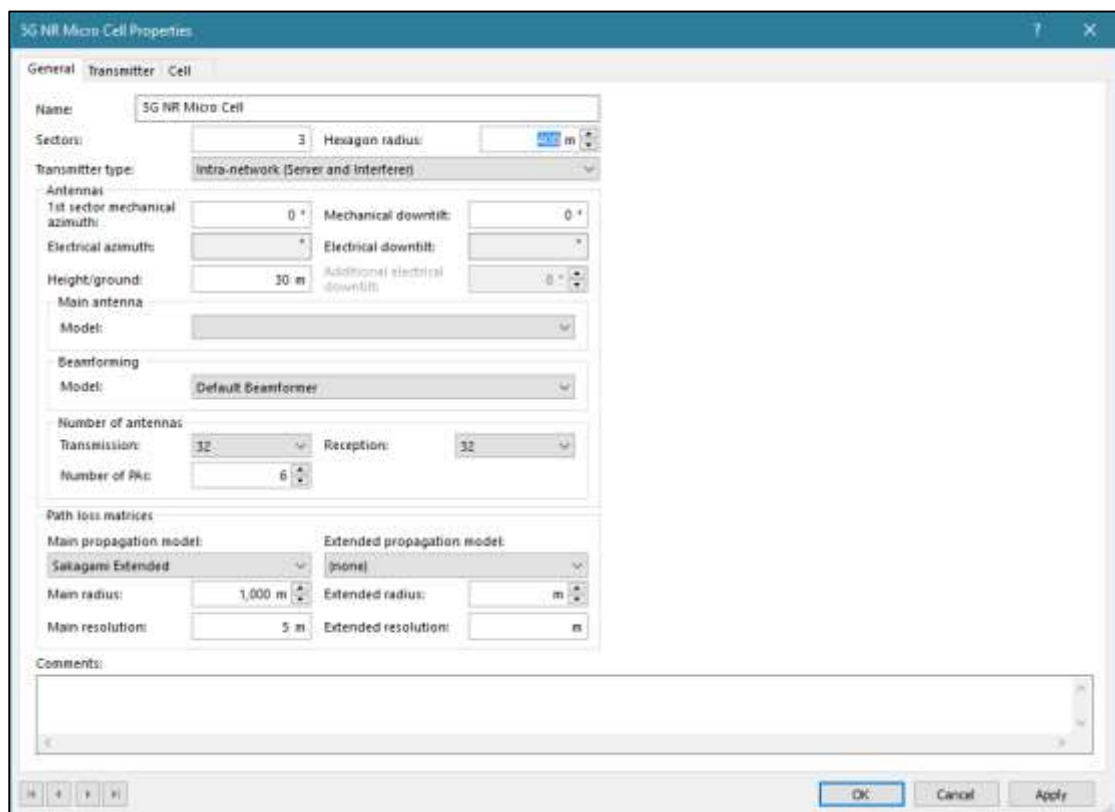
	<i>Femto cells</i>	<i>Pico cells</i>	<i>Micro cells</i>	<i>Macro cells</i>
Output power	1–250 mW	250 mW–1 W	1–10 W	10–50+ W
cell radius	10–100 m	100–200 m	0.2–2 km	8–30 km
Users	1–30	30–100	100–2000	2000+
DAS integration	No	Yes	Yes	Yes

According to all information previously mentioned, a base station template named (5G NR Micro Cell) with a hexagon radius of 400m was chosen for this study; therefore, there were 24 sites created within the studied area.



**Figure 3. 9:** Distribution of the 24 sites

The hexagon radius and other specifications of this base station template are as shown in the following figure;



**Figure 3. 10:** specifications of base station template of 5G NR technology

Using a hexagon radius of 400m we get a site-to-site distance of 1,200m. We get this result according to the following formula;

$$R_{\text{site}} = \sqrt{3} \times R_{\text{sector}}$$

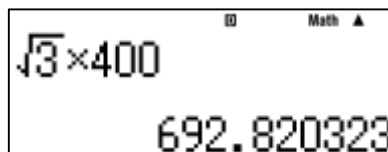
$$DISTANCE_{\text{site-to-site}} = 3 \times R_{\text{sector}} = \sqrt{3} \times R_{\text{site}}$$

**Figure 3. 11:** Site radius and site-to-site formulas

Where;

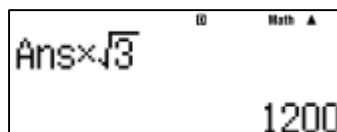
R= Radius of the site or the sector.

Therefore, we can calculate it in the following way;



A calculator display showing the calculation of the site radius. The input is  $\sqrt{3} \times 400$  and the result is 692.820323.

And since we have 3 sectors in each site we multiply this result by  $\sqrt{3}$



A calculator display showing the final calculation. The input is  $\text{Ans} \times \sqrt{3}$  and the result is 1200.

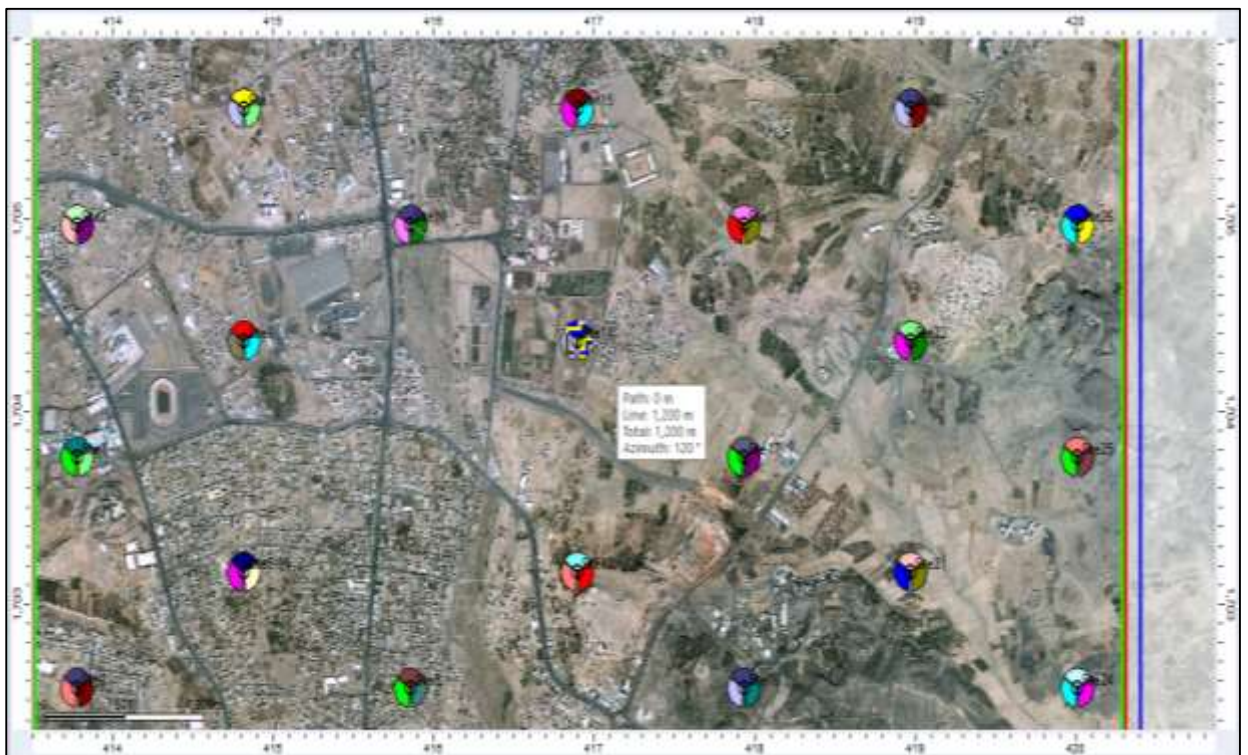
So the site-to-site distance = 1,200m, and using the hexagon radius feature within Atoll software we can get this result automatically, and in the following figure It is noticed that there is that the algorithm of Atoll has given us a similar result to the one that has been found using the formula.





**Figure 3. 12:** site-to-site distance from site 21 to site 25

The site-to-site distance is 1,200 from any site to another in the first tire. This can be noticed in another example in the following figure;



**Figure 3. 13:** site-to-site distance from site 10 to site 14

### 3.2.2.4 Users Density

The high density of users and extreme throughput and latency demands of these applications cannot realistically be met by Wi-Fi or LTE. Only 5G can support more than 500 users per cell, provide high cell edge performance with an acceptable QoE and deliver an end-to-end latency of less than 5 milliseconds to avoid virtual reality motion sickness (Devaki et al., 2019).

5G represents more than an expansion of bandwidth capacity and expects to enable new business models, streamline the service delivery and support different vertical use cases. It is required to support actual and future diverse set of vertical industries and simplify their provisioning process that calls for new architectural frameworks (Simona et al., 2018).

According to (Simona et al., 2018), User experience KPI's and system performance requirements such as connection density (active users simultaneously) of micro cells of 5G are presented in the following table;

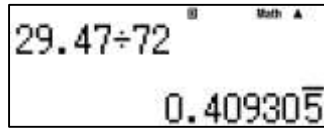
**Table 3. 4:** User experience KPI's and system performance requirements

	Use case category	User Experience Data Rate	E2E Latency	Mobility	Connection Density
Broadband access in dense area	Broadband access in dense areas	DL: 300 Mbps UL: 50 Mbps	10 ms	0-100 km/h	200-2500 /km <sup>2</sup>
	Indoor ultra-high broadband access	DL: 1 Gbps UL: 500 Mbps	10 ms	Pedestrian	75,000 / km <sup>2</sup>
	Broadband access in a crowd	DL: 25 Mbps UL: 50 Mbps	10 ms	Pedestrian	150,000 / km <sup>2</sup>

According to table 3.3 that was presented previously in the site distribution part part the number of active users within a 5G micro cell is 100-2000 within a cell radius of 200m – 2000m.

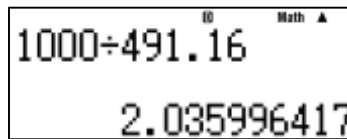
According to all information previously mentioned, the user density is specified by 1518 active users per cell, and since we have an area of 29.47 km<sup>2</sup> and this area has 24 sites, and each site has 3 cells, then the whole area of the study is covered by approximately 72, and if we divide the size of area

in km which is  $29.47 \text{ km}^2$  by the number of the cells which is 72, then we get the following result;



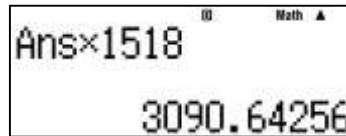
29.47 ÷ 72 = 0.409305

That means each cell covers approximately  $0.409 \text{ km}^2$ , then we divide 1000 (1km) by the pervious result we got, and we get the following result;



1000 ÷ 491.16 = 2.035996417

That means we need about 2.036 of micro cells to cover  $1 \text{ km}^2$  on the map, then we multiply this value by the number of active users that has been chosen earlier;



Ans × 1518 = 3090.64256

That means we set the user density value in Atoll software to be 3090 users per  $\text{km}^2$ . This value is shown in the following figure;

	Id	Traffic Density (No. users/ $\text{km}^2$ )
	1	3,090
*		

**Figure 3. 14:** Users density value per  $\text{km}^2$  in 5G micro cell

## **3.3 Technology Requirements**

This part discusses the other requirements that have not been mentioned in the previous parts. So far the cell radius and users density have been discussed in details, and in this part other requirements are discussed, but let us always put in mind that some requirements like data rates which are mentioned in some literature references are theoretical rather than practical, and some of them were published before the realistic tests and deployments have taken place in a wide range, hence, the parameters that have been chosen in the current study are average realistic values.

### **3.3.1 LTE**

The key target requirements of LTE are to have a peak downlink data rate of 100 Mbps and peak uplink data rate of 50 Mbps. Other salient requirements include user plane latency of less than 5ms and call set up time to be less than 50ms. One of the features that make LTE different from its predecessors is the requirement to support scalable bandwidth, from 5 to 20MHz. The requirements on user experience are to be optimized for low mobility conditions while there will be graceful degradation of the service quality with increasing user mobility and increasing distance from base station (Prasad et al., 2010).

LTE-Advanced will support peak data rates of 1 Gbps for the downlink, and a minimum of 100 Mbps for the uplink. The target uplink data rate, however, is 500 Mbps. For latencies, the requirements are 50ms for idle to connected and 10ms for dormant to connected. The system will be optimized for 0-190 km/h (Ali et al., 2011) .

According to (Starr et al., 2014), the requirements of LTE releases are presented in the following table;

**Table 3. 5 : LTE requirements according to (Starr et al., 2014)**

		LTE (Release 8)	IMT-Advanced	LTE-Advanced (Release 10)
Peak data rate	DL	300 Mbit/s	1 Gbps (low mobility) 100 Mbit/s (high mobility)	1 Gbps
	UL	75 Mbit/s		500 Mbit/s
Peak spectrum efficiency (bps/Hz)	DL	15	15	30
	UL	3.75	6.75	15

According to all information previously mentioned, the requirements of LTE technology that are expected to be achieved in the current study were set within the software as show in the following figure;

Name	Type	Min DL throughput demand (kbps)	Min UL throughput demand (kbps)	Max Throughput Demand (DL) (kbps)	Max Throughput Demand (UL) (kbps)	Average Requested Throughput (DL) (kbps)	Average Requested Throughput (UL) (kbps)
High Speed Internet	Data	1	1	8e+007	8e+007	4e+007	4e+007
Mobile Internet Access	Data	64	32	8e+007	8e+007	50,000	50,000
Video Conferencing	Voice	64	64	64,000	64,000	64	64
VoIP	Voice	12.2	12.2	32,000	32,000	12.2	12.2
*							

**Figure 3. 15:** service requirements setting of LTE within Atoll services table

### 3.3.2 5G NR

Historically, every new generation of mobile technology was designed to deliver better performance beyond what the evolution of its predecessor could bring. 5G should improve the performance envelope for mobile communication by a magnitude that might not be feasible with LTE and its evolution. The most common performance requirements as identified by

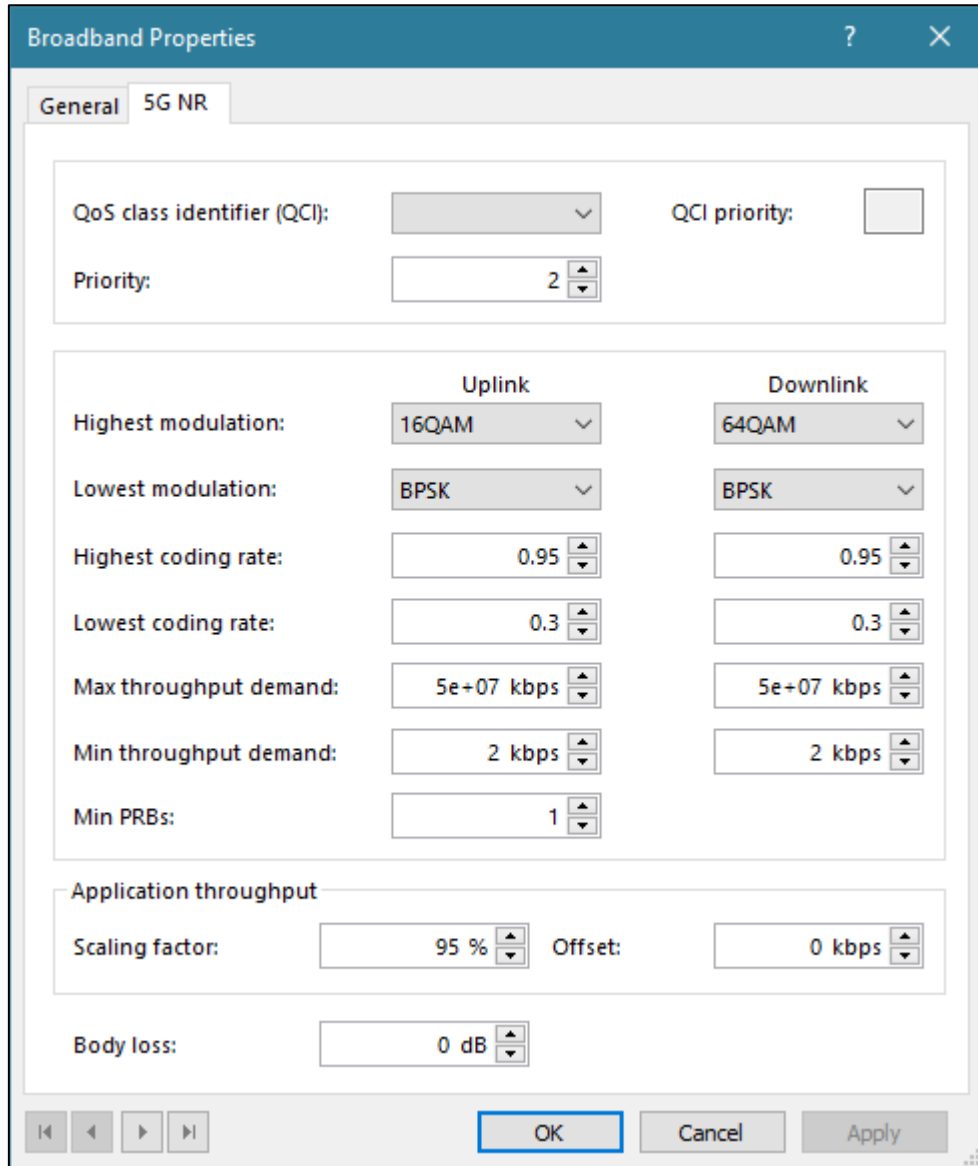
leading industry experts are summarized below. Partially, the requirements have been defined relative to the (initial) 4G technology capabilities (Peter, 2018):

- 1-10 Gigabit per second (Gbit/s) per connection.
- 1 ms latency.
- 1000x better capacity.
- 10-100x better connection density (number of connected devices per geographical area).
- (Perception of) 99.999% availability.
- (Perception of) 100% coverage.
- 1000 x times more capacity at half of the energy consumption.
- Up to 10 years battery life for low power, machine-type devices.

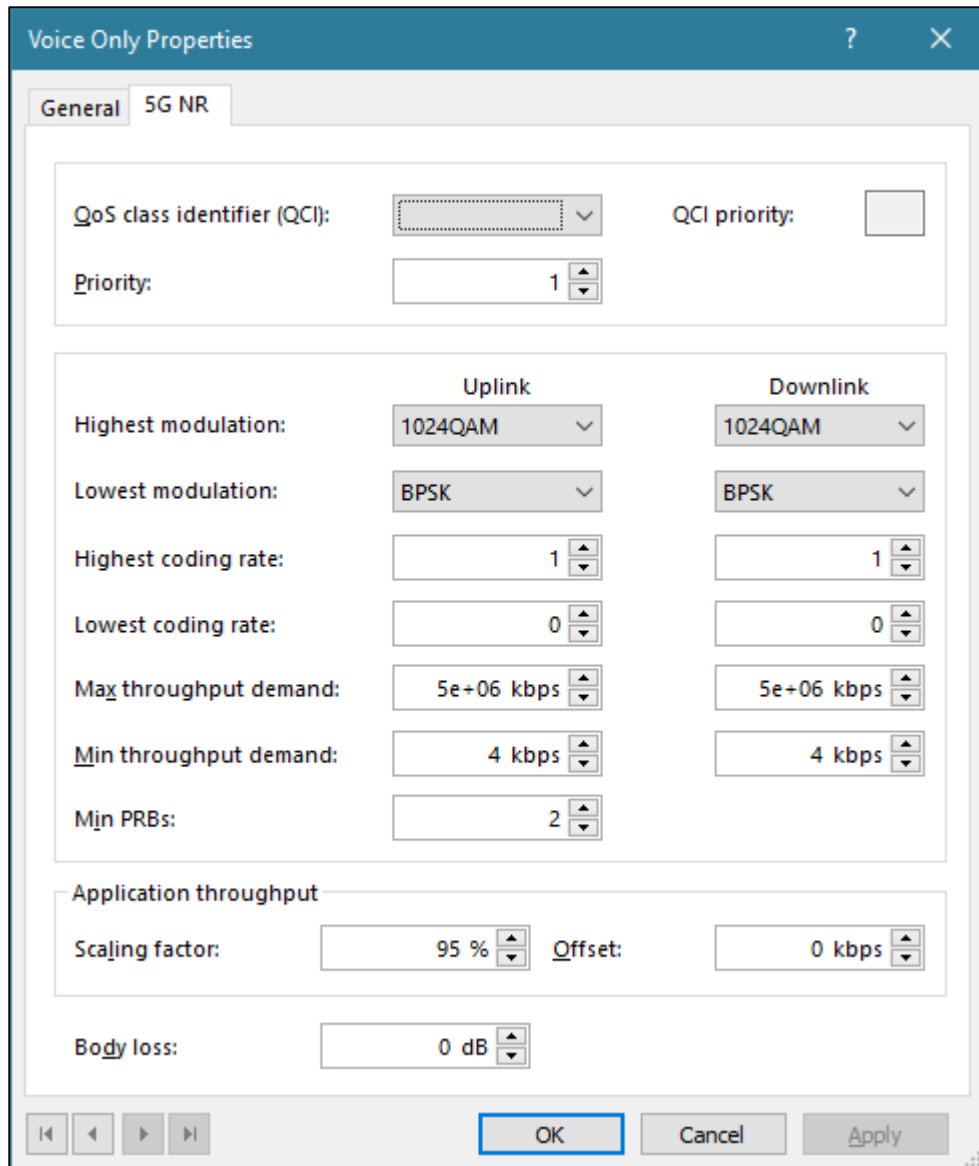
5G NR aims to address a variety of usage scenarios from enhanced mobile broadband (eMBB) to ultra-reliable low-latency communications (URLLC) to massive machine type communications (mMTC). 5G NR can meet the performance requirements set by the ITU for international mobile telecommunications for the year 2020 (IMT-2020) (Bennis, 2020):

- 20 Gbps DL peak data rate and 10 Gbps UL peak data rate in the eMBB usage scenario.
- 30 bps/Hz DL peak spectral efficiency and 15 bps/Hz UL peak spectral efficiency in the eMBB usage scenario.
- 100 Mbps DL 5%ile user experienced data rate and 50 Mbps UL 5%ile user experienced data rate in the dense urban eMBB test environment.
- 0.3 bps/Hz, 0.225 bps/Hz, and 0.12 bps/Hz DL 5%ile user spectral efficiency in the indoor hotspot, dense urban, rural eMBB usage scenario, respectively; 0.21 bps/Hz.

According to all information previously mentioned, the requirements of 5G NR technology that are expected to be achieved in the current study were set within the software as show in the following figures;



**Figure 3. 16:** Broadband service properties window for 5G NR



**Figure 3. 17:** Voice Only properties window for 5G NR

### 3.4 Initial Settings

This part discusses the initial settings that have been set at the beginning of the design process. Those initial setting are mostly set by default. Those settings do not guarantee good results, and to achieve good results and accomplish the objectives of the current study there will a be a series of changes done on those settings during the optimization process. All of this will be discussed later on in next parts. Atoll environment contains a large library of different settings and features included in several folders and sub-



folders that has different tables, windows and tabs, and the following part will present the most important settings that play a vital impact on the performance and the results.

### 3.4.1 LTE

#### 3.4.1.1 Sites Initial Settings

The following figure shows the initial settings of the sites:

Name	X	Y	Altitude (m)	Comments	Support Height (m)	Support Type	Max S1 interface throughput (DL) (kbps)	Max S1 interface throughput (UL) (kbps)
Site0	414,470	1,702,508	[2,240]		50		950,000	950,000
Site1	414,470	1,705,508	[2,230]		50		950,000	950,000
Site3	417,068	1,704,008	[2,236]		50		950,000	950,000
Site4	419,666	1,702,508	[2,264]		50		950,000	950,000
Site5	419,666	1,705,508	[2,241]		50		950,000	950,000

**Figure 3. 18:** Initial settings of sites in LTE design

#### 3.4.1.2 Transmitters Initial Settings

The following table shows the initial settings of each transmitter of the 15 transmitters deployed on the area of the study;

**Table 3. 6:** Initial settings of transmitters in LTE design

Site	
Transmitter	
Active	TRUE
Transmitter Type	Intra-network (Server and Interferer)
Antenna	100deg 14dBi 0Tilt Broadcast
DX (m)	0
DY (m)	0
Height (m)	25
Azimuth (°)	0
Mechanical Downtilt (°)	0
Additional Electrical Downtilt (°)	0
Shared Antenna	
Shared pattern	
Smart Antenna Equipment	

Number of Transmission Antenna Ports	2
Number of Reception Antenna Ports	2
Transmitter Equipment	
TMA Equipment	
Feeder Equipment	
Transmission Feeder Length (m)	0
Reception Feeder Length (m)	0
Miscellaneous Transmission Losses (dB)	0
Miscellaneous Reception Losses (dB)	0
Transmission losses (dB)	0
Reception losses (dB)	0
Noise Figure (dB)	5
Main Propagation Model	(Default model)
Main Calculation Radius (m)	7,000
Main Resolution (m)	50
Extended Propagation Model	(none)
Extended Calculation Radius (m)	
Extended Resolution (m)	
Hexagon groups	
Hexagon radius (m)	1,000
Comments	

### 3.4.1.3 Cells Initial Settings

The following table shows the initial settings of each cell of the 15 cells covering the area of the study;

Table 3. 7: Initial settings of cells in LTE design

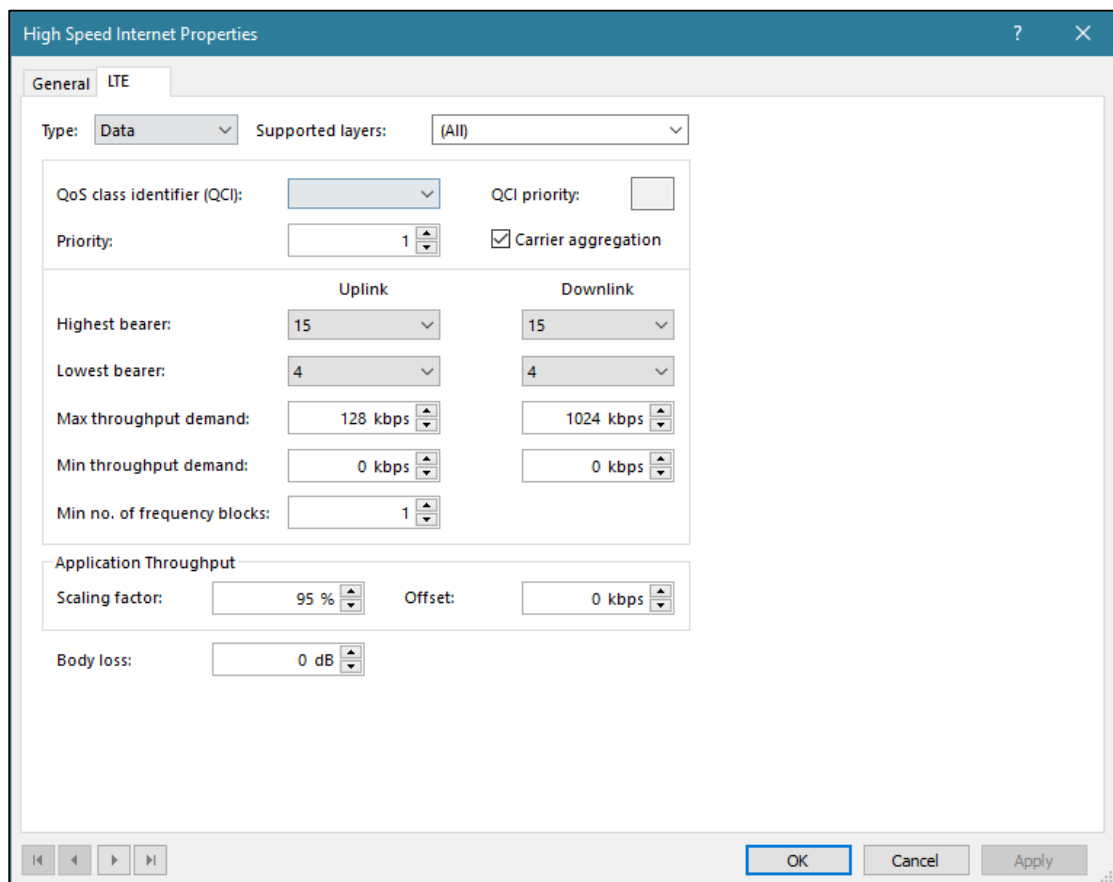
Transmitter	Site0_1
Name	Site0_1(0)
ID	
Active	TRUE
Order	
Layer	Macro Layer
Cell Type	1
Frequency Band	E-UTRA Band 1 - 10MHz
Channel Number	50
Channel Allocation Status	Not Allocated

Physical Cell ID Domain	
Physical Cell ID	0
PSS ID	0
SSS ID	0
PSS ID status	Not Allocated
SSS ID status	Not Allocated
Reuse distance (m)	
Max Power (dBm)	43
RS EPRE per antenna port (dBm)	15.4
SS EPRE Offset / RS (dB)	0
PBCH EPRE Offset / RS (dB)	0
PDCCH EPRE Offset / RS (dB)	0
PDSCH EPRE Offset / RS (dB)	0
Min RSRP (dBm)	-140
Cell Selection Threshold (dB)	0
Cell Individual Offset (dB)	0
Handover Margin (dB)	0
ICIC Delta Path Loss Threshold (dB)	0
Fractional Power Control Factor	1
Max Noise Rise (UL) (dB)	6
Max PUSCH C/(I+N) (dB)	20
Interference Coordination Support	0
Frame configuration	
TDD subframe configuration	
Almost Blank Subframe (ABS) Pattern	
Reception Equipment	Default Cell Equipment
Scheduler	Proportional Fair
Diversity Support (DL)	Transmit Diversity;SU-MIMO
Diversity Support (UL)	3
Number of co-scheduled MU-MIMO users (DL)	2
Number of co-scheduled MU-MIMO users (UL)	2
Traffic Load (DL) (%)	100
Traffic Load (UL) (%)	100
UL Noise Rise (dB)	0
Max Traffic Load (DL) (%)	100
Max Traffic Load (UL) (%)	100
Cell-edge Traffic Ratio (DL) (%)	0
ICIC Noise Rise (UL) (dB)	0
Inter-technology DL Noise Rise (dB)	0
Inter-technology UL Noise Rise (dB)	0
AAS Usage (DL) (%)	0

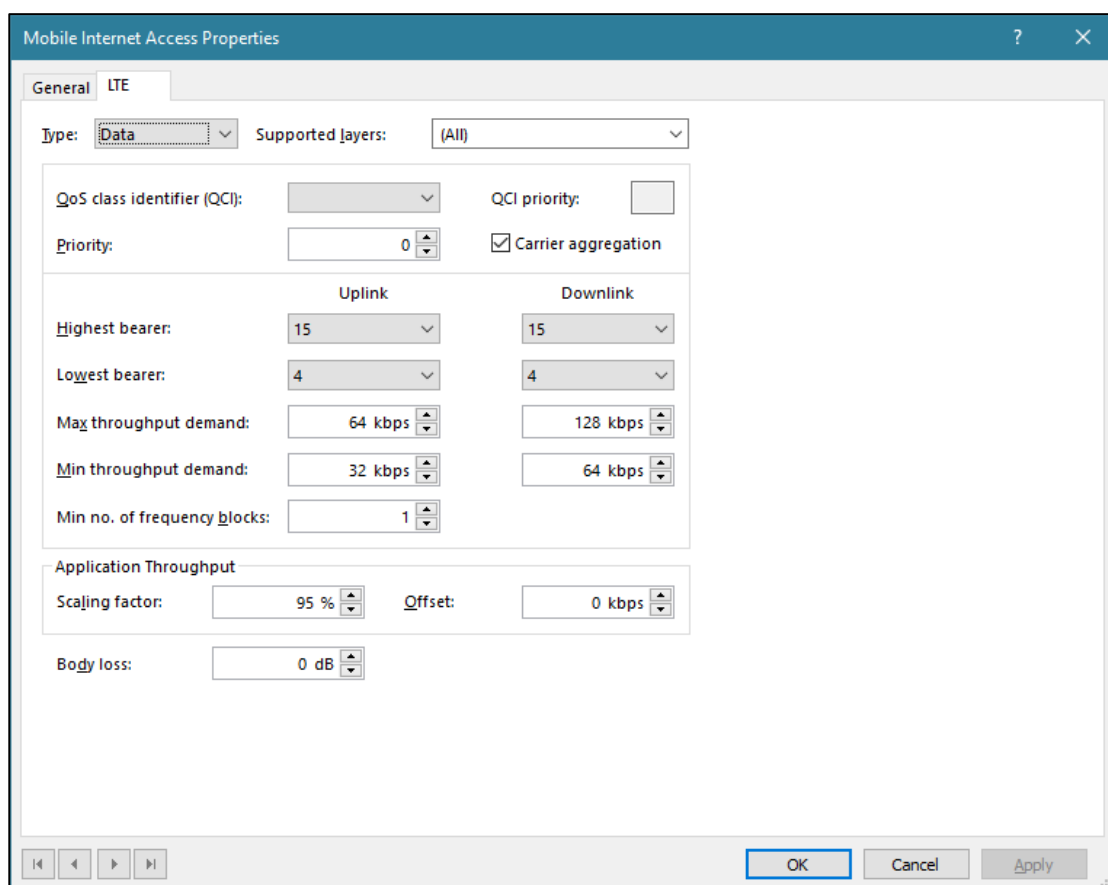
Angular distributions of interference (AAS)	1 0
Number of Users (DL)	1
Number of Users (UL)	1
Max Number of Users	
Max number of intra-technology neighbours	16
Max number of inter-technology neighbours	16
Comments	
Number of Required PRACH RSI	1
PRACH Root Sequences	
PRACH RSI Allocation Status	Not Allocated

### 3.4.1.4 Services Initial Settings

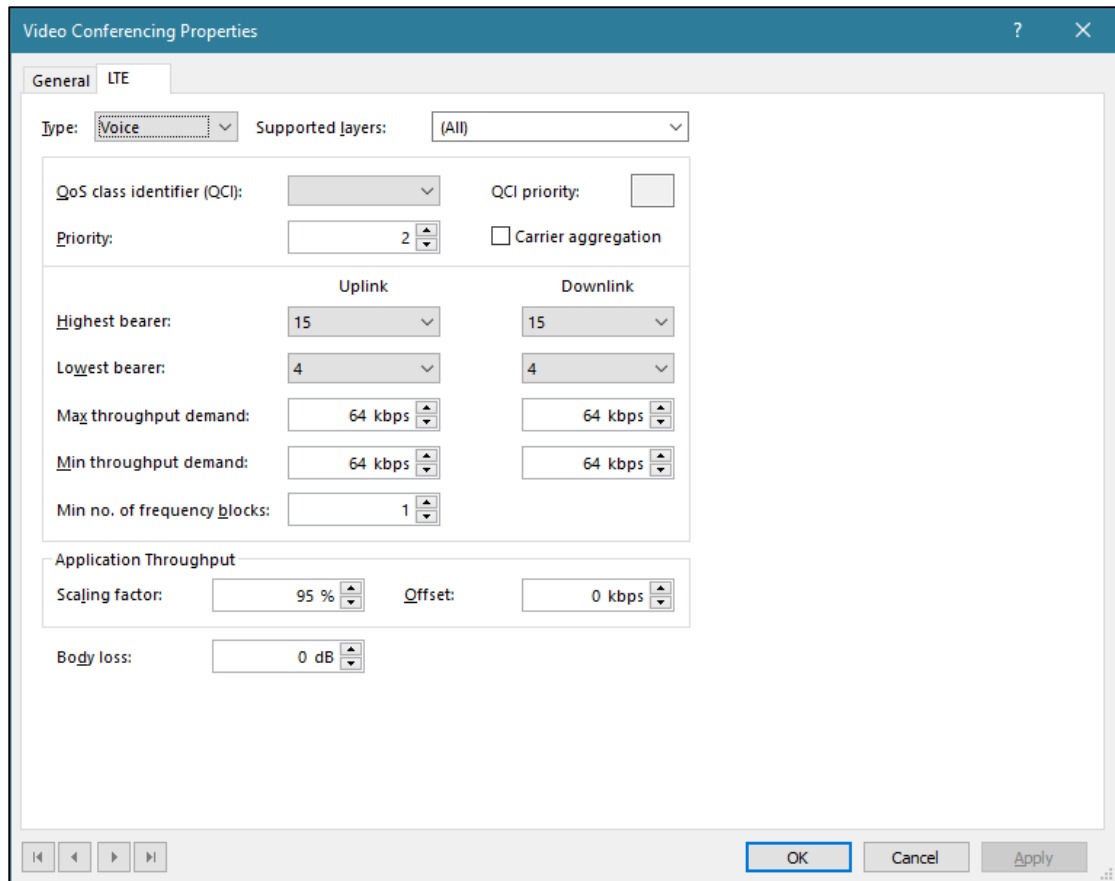
The following figures show the initial settings of the services available in LTE design;



**Figure 3. 19:** Initial settings of high speed internet service of LTE



**Figure 3. 20:** Initial settings of mobile internet access service of LTE



**Figure 3. 21:** Initial settings of video conferencing service of LTE

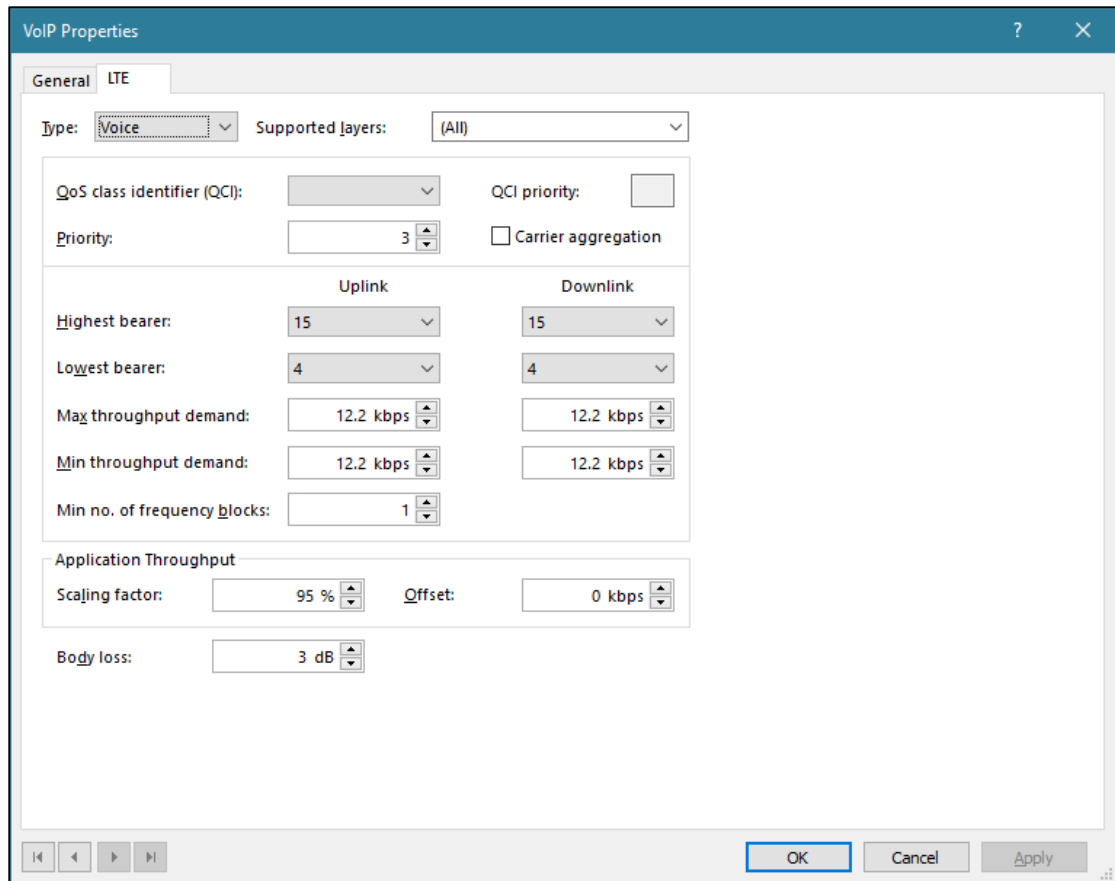


Figure 3. 22: Initial settings of voice only service of LTE

### 3.4.1.5 Mobility Initial Settings

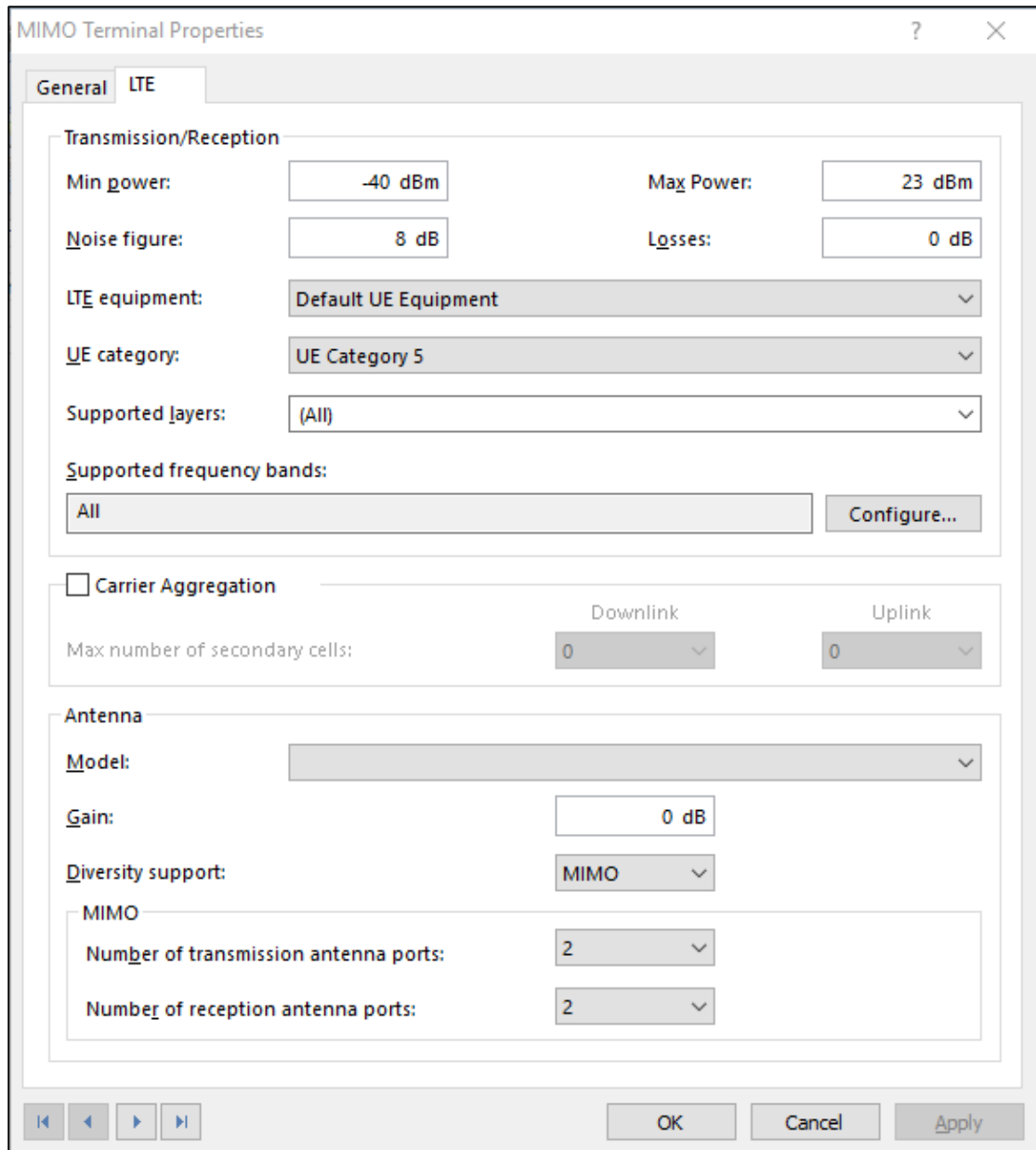
The following table shows the initial settings of the mobility types available in LTE design;

**Table 3. 8:** initial settings of mobility in LTE design

Name	Average Speed (km/h)
50 km/h	50
90 km/h	90
Fixed	0
Pedestrian	3

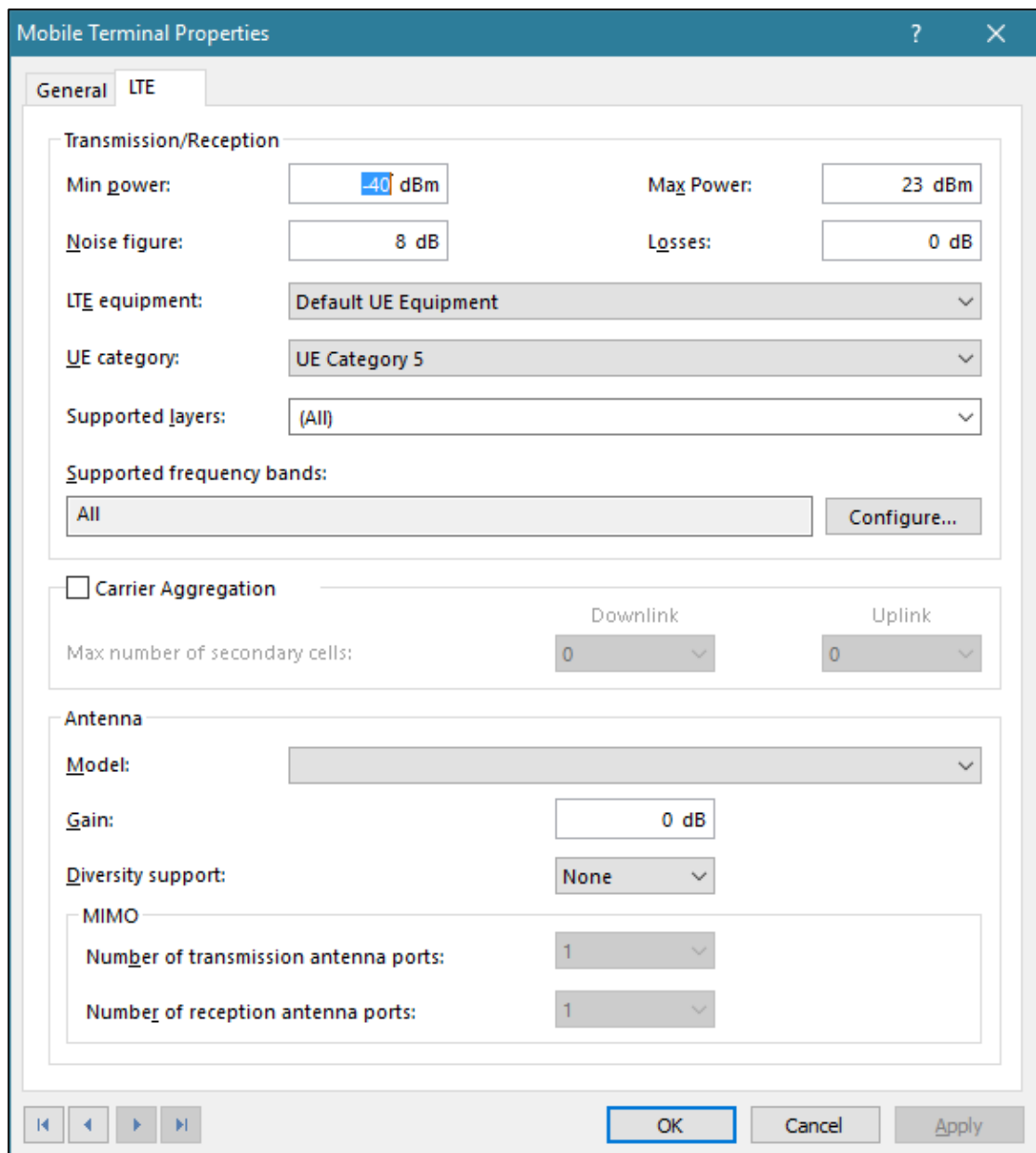
### 3.4.1.6 Terminals Initial Settings

The following figures show the initial settings of the terminals available in LTE design;



**Figure 3. 23:** Initial settings of MIMO terminal in LTE design





**Figure 3. 24:** Initial settings of mobile terminal in LTE design

### 3.4.1.7 User Profiles Initial Settings

The following tables show the initial settings of the user profiles available in LTE design;

**Table 3. 9:** Initial settings of Business User profile in LTE design

Service	Terminal	Calls/hour	Duration (sec.)	UL Volume (KBytes)	DL Volume (KBytes)
High Speed Internet	MIMO Terminal	0.05		2,000	15,000
Video Conferencing	MIMO Terminal	0.01	600		
VoIP	Mobile Terminal	0.2	240		
Mobile Internet Access	MIMO Terminal	0.1		700	4,500

**Table 3. 10:** Initial settings of Standard User profile in LTE design

Service	Terminal	Calls/hour	Duration (sec.)	UL Volume (KBytes)	DL Volume (KBytes)
Mobile Internet Access	MIMO Terminal	0.1		700	4,500
VoIP	Mobile Terminal	0.2	240		

### 3.4.2 5G NR

#### 3.4.2.1 Sites Initial Settings

The following figure shows the initial settings of the 24 sites:

Name	X	Y	Altitude (m)	Comments	Support Height (m)	Support Type	Alias	Max Backhaul Throughput (DL) (kbps)	Max Backhaul Throughput (UL) (kbps)
Site0	413,778	1,702,566	[2,260]		50		950,000	950,000	950,000
Site1	413,778	1,703,766	[2,246]		50		950,000	950,000	950,000
Site10	415,857	1,704,966	[2,220]		50		950,000	950,000	950,000
Site11	415,857	1,706,166	[2,213]		50		950,000	950,000	950,000
Site13	416,896	1,703,166	[2,239]		50		950,000	950,000	950,000
Site14	416,896	1,704,366	[2,230]		50		950,000	950,000	950,000
Site15	416,896	1,705,566	[2,221]		50		950,000	950,000	950,000
Site16	417,935	1,702,566	[2,279]		50		950,000	950,000	950,000
Site17	417,935	1,703,766	[2,240]		50		950,000	950,000	950,000
Site18	417,935	1,704,966	[2,232]		50		950,000	950,000	950,000
Site19	417,935	1,706,166	[2,219]		50		950,000	950,000	950,000
Site2	413,778	1,704,966	[2,230]		50		950,000	950,000	950,000
Site21	418,974	1,703,166	[2,260]		50		950,000	950,000	950,000
Site22	418,974	1,704,366	[2,250]		50		950,000	950,000	950,000
Site23	418,974	1,705,566	[2,230]		50		950,000	950,000	950,000
Site24	420,014	1,702,566	[2,280]		50		950,000	950,000	950,000
Site25	420,014	1,703,766	[2,278]		50		950,000	950,000	950,000
Site26	420,014	1,704,966	[2,265]		50		950,000	950,000	950,000
Site27	420,014	1,706,166	[2,240]		50		950,000	950,000	950,000
Site3	413,778	1,706,166	[2,220]		50		950,000	950,000	950,000
Site5	414,818	1,703,166	[2,234]		50		950,000	950,000	950,000
Site6	414,818	1,704,366	[2,232]		50		950,000	950,000	950,000
Site7	414,818	1,705,566	[2,229]		50		950,000	950,000	950,000
Site8	415,857	1,702,566	[2,231]		50		950,000	950,000	950,000
*									

Figure 3. 25

**Figure 3. 26:** Initial settings of sites in 5G NR design

### 3.4.2.2 Transmitters Initial Settings

The following table shows the initial settings of each transmitter of the 72 transmitters deployed on the area of the study;

**Table 3. 11:** Initial settings of transmitters in 5G NR design

<b>Site</b>	# of site
Transmitter	# of transmitter
Azimuth (°)	0
Mechanical Downtilt (°)	0
Active	TRUE
Transmitter Type	Intra-network (Server and Interferer)
Height (m)	30
Antenna	
DY (m)	0
DX (m)	0
Use Absolute Coordinates	0
X	####
Y	####
Additional Electrical Downtilt (°)	0
Shared Antenna	
Shared pattern	
Number of Transmission Antennas	128
Number of Reception Antennas	128
Number of Power Amplifiers (DL)	1
Transmitter Equipment	
TMA Equipment	
Feeder Equipment	
Transmission Feeder Length (m)	0
Reception Feeder Length (m)	0
Miscellaneous Transmission Losses (dB)	0
Miscellaneous Reception Losses (dB)	0
Transmission losses (dB)	0
Reception losses (dB)	0
Noise Figure (dB)	5
Main Propagation Model	(Default model)
Main Calculation Radius (m)	####
Main Resolution (m)	50

Extended Propagation Model	(none)
Extended Calculation Radius (m)	
Extended Resolution (m)	
Comments	
Frequency Band	n78
Max Range (m)	
Beamforming Model	Default Beamformer
Radio Access Technology	5G NR
Layer	Macro Layer

### 3.4.2.3 Cells Initial Settings

The following table shows the initial settings of each cell of the 72 cells covering the area of the study;

Table 3. 12: Initial settings of cells in 5G NR design

Transmitter	# of transmitter
Name	# of cell
Active	TRUE
ID	
Order	1
Carrier	50 MHz - NR-ARFCN 621667
Channel Allocation Status	Not Allocated
Physical Cell ID	0
Physical Cell ID Domain	
PSS ID	0
PSS ID Status	Not Allocated
SSS ID	0
SSS ID Status	Not Allocated
Reuse Distance (m)	
Max Power (dBm)	50
SSS EPRE (dBm)	15
PSS EPRE Offset / SSS (dB)	3
PBCH EPRE Offset / SSS (dB)	0
PDCCH EPRE Offset / SSS (dB)	0
PDSCH EPRE Offset / SSS (dB)	0
Layer	Macro Layer
Cell Type	1
Min SS-RSRP (dBm)	-140
Cell Individual Offset (dB)	0
Cell Selection Threshold (dB)	0

Handover Margin (dB)	0
Cell Edge Margin (dB)	
SS/PBCH Numerology	0 (15 kHz)
SS/PBCH Periodicity	10 ms
SS/PBCH OFDM Symbols	{4,8,16,20}+28n [Lmax=4]
PDCCH Overhead (OFDM Symbols)	1
Traffic Numerology	2 (60 kHz Normal CP)
TDD DL OFDM Symbols (%)	50
Radio Equipment	5G NR Radio Equipment
Scheduler	Proportional Fair
Diversity Support (DL)	7
Diversity Support (UL)	7
Number of MU-MIMO Users (DL)	1
Number of MU-MIMO Users (UL)	1
Max Number of Users	
Number of Users (DL)	1
Number of Users (UL)	1
Traffic Load (DL) (%)	100
Traffic Load (UL) (%)	100
Max Traffic Load (DL) (%)	100
Max Traffic Load (UL) (%)	100
Beam Usage (DL) (%)	
Beam Usage (UL) (%)	
UL Noise Rise (dB)	0
Additional DL Noise Rise (dB)	0
Additional UL Noise Rise (dB)	0
Fractional Power Control Factor	1
PRACH Preamble Format [Max Cell Radius]	
Number of Required PRACH RSI	10
PRACH RSIs	
PRACH RSI Domain	
PRACH RSI Allocation Status	Not Allocated
PRACH Resource Blocks	
PRACH subframes	
PRACH RSI/Cell Size Mapping	
Max number of 4G/5G neighbours	16
Max number of inter-technology neighbours	16
Comments	

### 3.4.2.4 Services Initial Settings

The following table shows the initial settings of the services available in 5G NR design;

**Table 3. 13:** initial settings of the services available in 5G NR design

Name	Type	Supported Layers	Average Requested Throughput (UL) (kbps)	Average Requested Throughput (DL) (kbps)	Uplink Activity Factor	Downlink Activity Factor
Broadband	Broadband	(All)	1,000	4,000	1	1
Internet	Data	(All)	200	400	1	1
Machine-Type	IoT	(All)	0	0	1	1
Video Call	Voice	(All)	128	128	1	1
Voice Call	Voice	(All)	24.4	24.4	0.4	0.4

### 3.4.2.5 Mobility Initial Settings

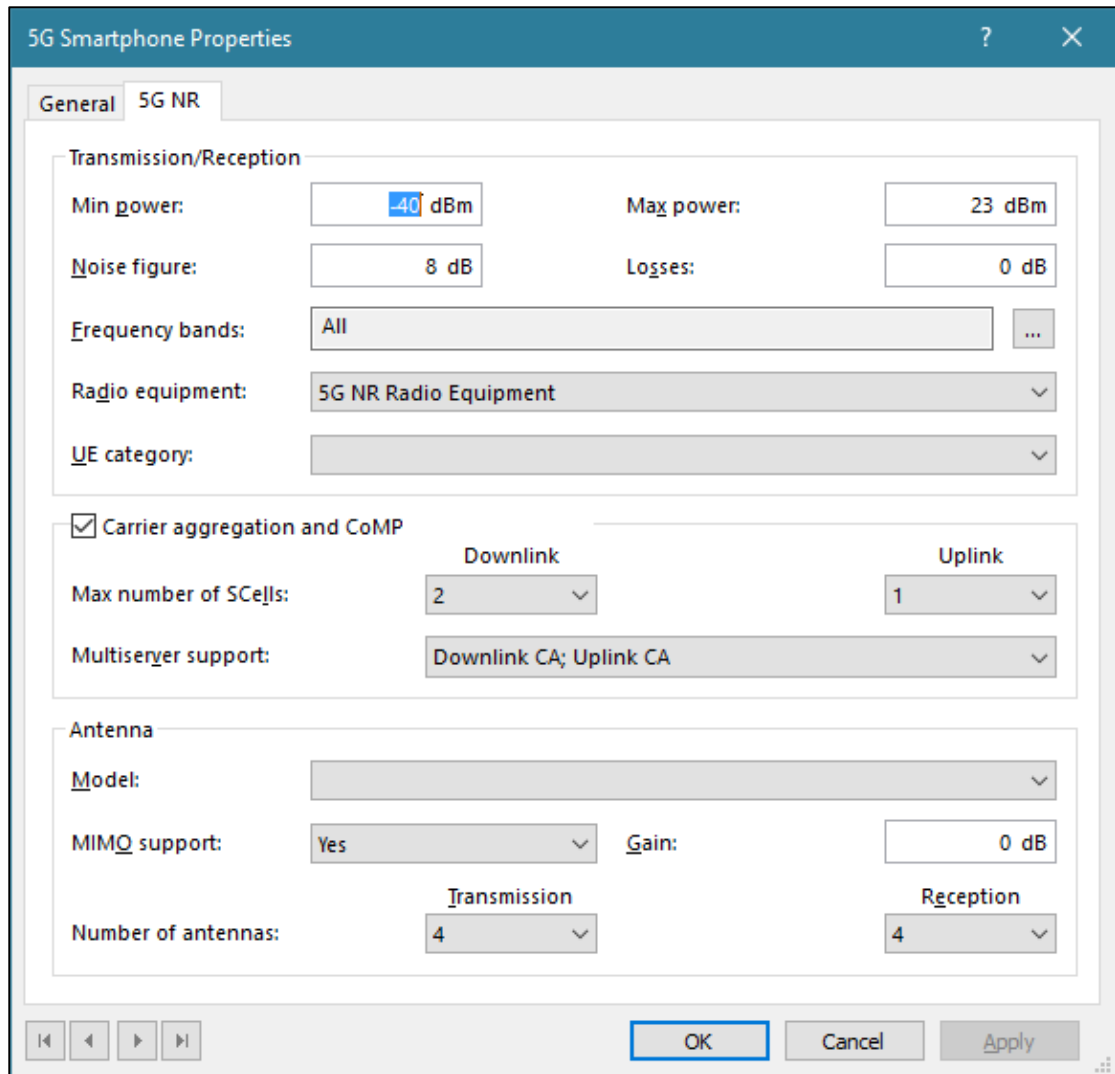
The following table shows the initial settings of the mobility types available in 5G NR design;

**Table 3. 14:** initial settings of mobility in 5G NR design

Name	Average Speed (km/h)
50 km/h	50
90 km/h	90
Fixed	0
Pedestrian	3

### 3.4.2.6 Terminals Initial Settings

The following figures show the initial settings of the terminals available in 5G NR design;



**Figure 3. 27:** Initial settings of 5G Smartphone terminal in 5G NR design

### 3.4.2.7 User Profiles Initial Settings

The following tables show the initial settings of the user profiles available in 5G NR design;

**Table 3. 15:** Initial settings of Business User profile in 5G NR design

Service	Terminal	Calls/hour	Duration (sec.)	UL Volume (KBytes)	DL Volume (KBytes)
Broadband	5G Smartphone	0	65	10,000	50,000
Video Call	5G Smartphone	0	600		
Voice Call	5G Smartphone	0	240		

**Table 3. 16:** Initial settings of Standard User profile in 5G NR design

Service	Terminal	Calls/hour	Duration (sec.)	UL Volume (KBytes)	DL Volume (KBytes)
Mobile Internet Access	MIMO Terminal	0.1		700	4,500
VoIP	Mobile Terminal	0.2	240		

### 3.5 Initial Predictions and Simulations

This part discusses the initial prediction and simulation results that have been gotten according to the initial settings that have been set. These results shows different parameters that can be used to judge the efficiency of performance in each technology. As mentioned earlier, these results do not accomplish the objectives of the study, and they will be optimized later on in the next part in order to get better results, and there will be a comparison that shows the results before and after the optimization process.

#### 3.5.1 LTE

This part presents the initial prediction and simulation results of LTE technology that have been gotten according to the initial settings that have been set.

##### 3.5.1.1 Coverage by Transmitter (DL)

The following figure shows the prediction result of Coverage by Transmitter (DL) in LTE technology;



**Figure 3. 28:** prediction result of Coverage by Transmitter (DL) in LTE technology

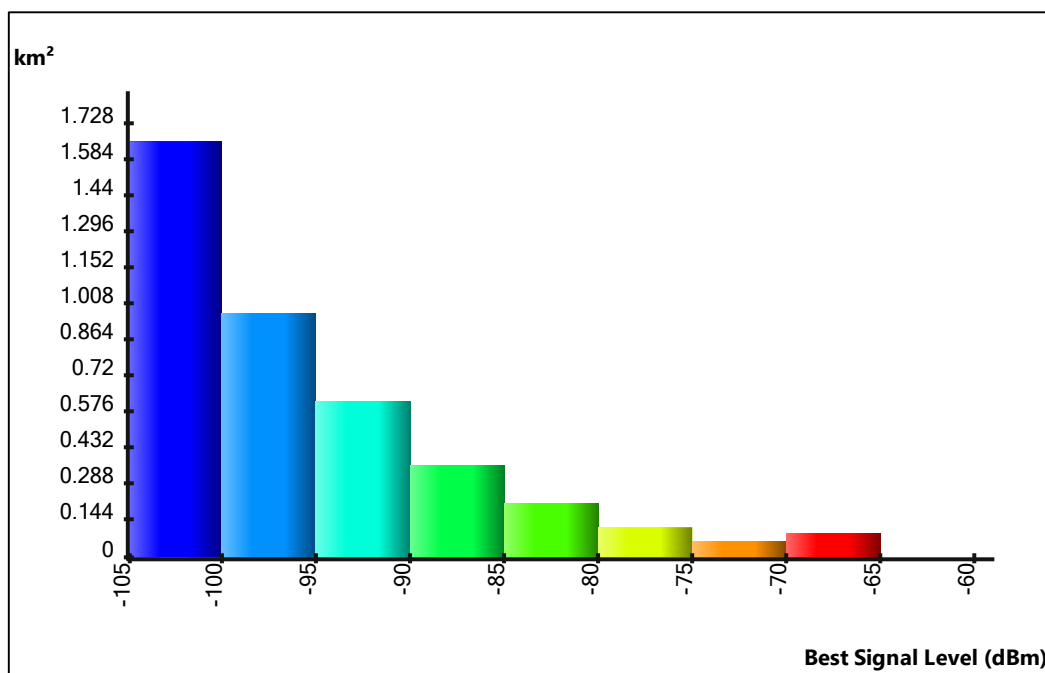


### 3.5.1.2 Coverage by Signal Level (DL)

The following figures show the map and histogram prediction results of Coverage by Signal Level (DL) in LTE technology;



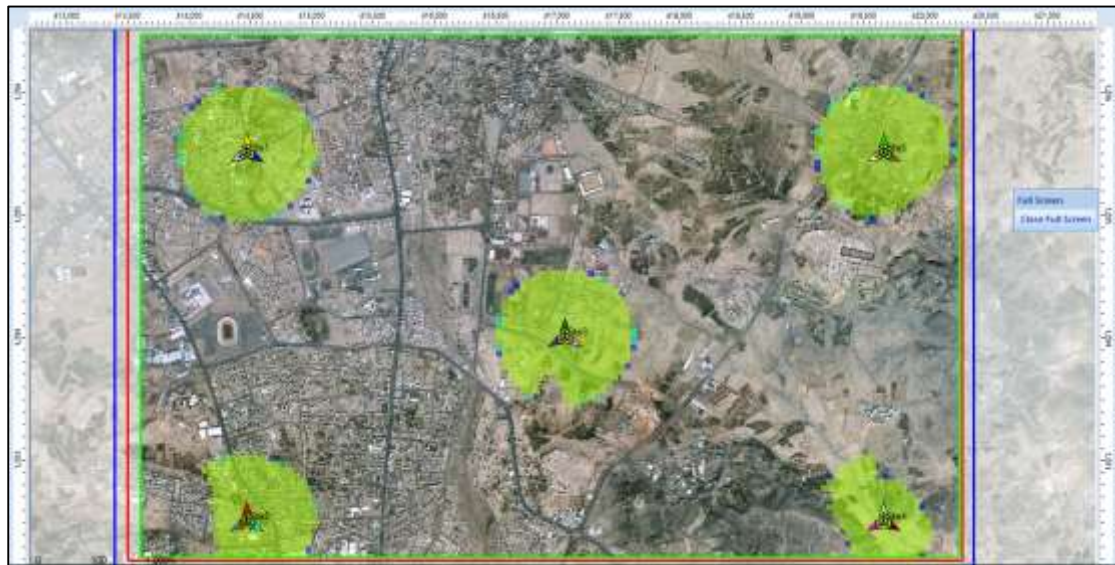
**Figure 3. 29:** prediction result of Coverage by Signal Level (DL) in LTE technology



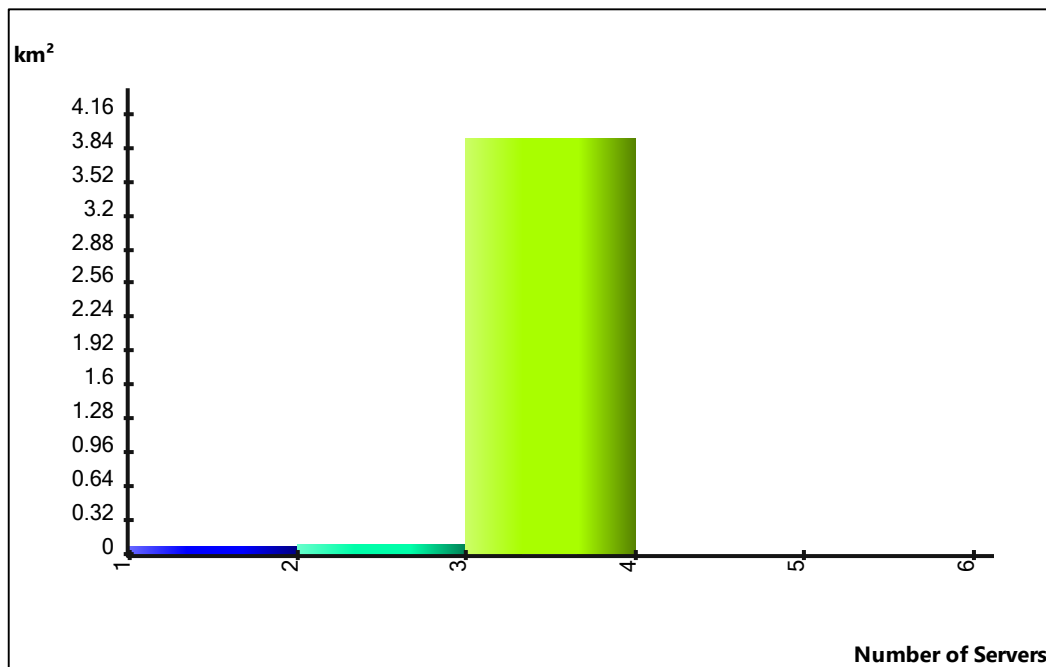
**Figure 3. 30:** prediction histogram of Coverage by Signal Level (DL) in LTE technology

### 3.5.1.3 Overlapping Zones (DL)

The following figures show the map and histogram prediction results of Overlapping Zones (DL) in LTE technology;



**Figure 3. 31:** prediction result of Overlapping Zones (DL) in LTE technology



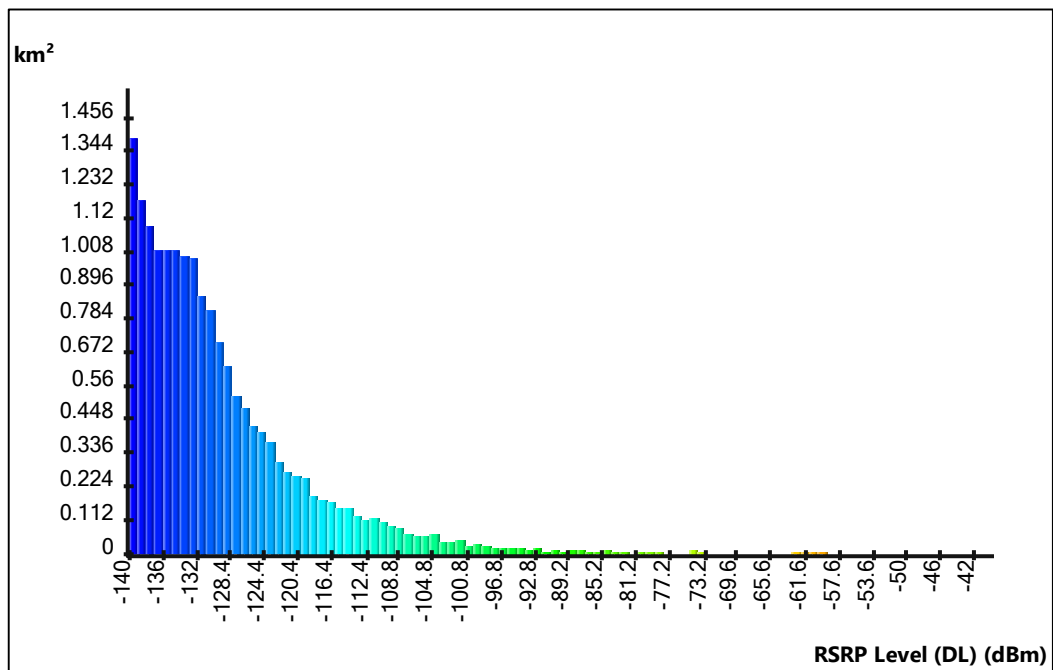
**Figure 3. 32:** prediction histogram of Overlapping Zones (DL) in LTE technology

### 3.5.1.4 Effective Signal Analysis (DL)

The following figures show the map and histogram prediction results of Effective Signal Analysis (DL) in LTE technology;



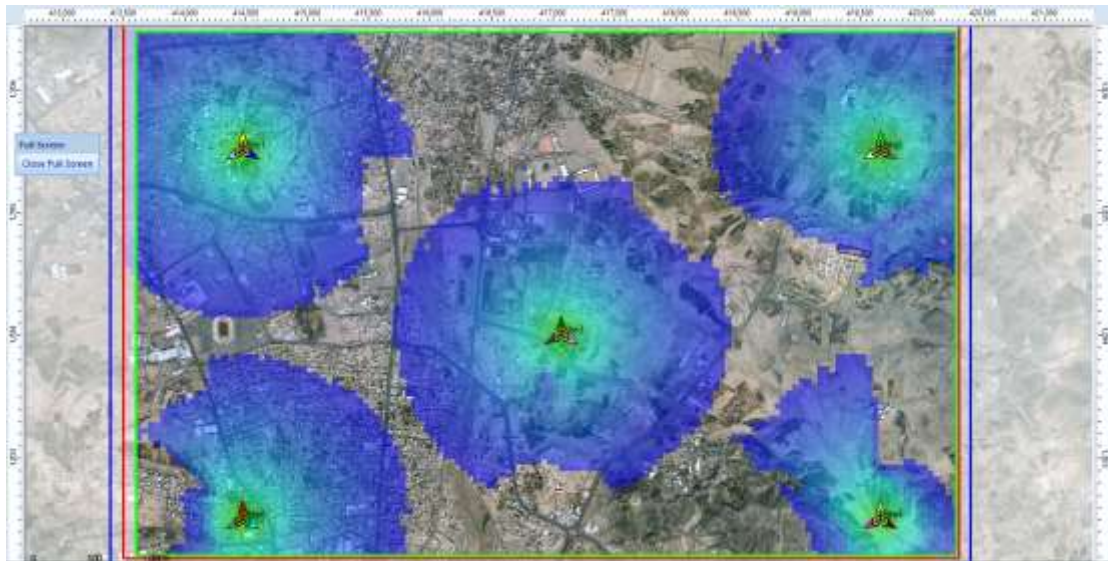
**Figure 3. 33:** prediction result of Effective Signal Analysis (DL) in LTE technology



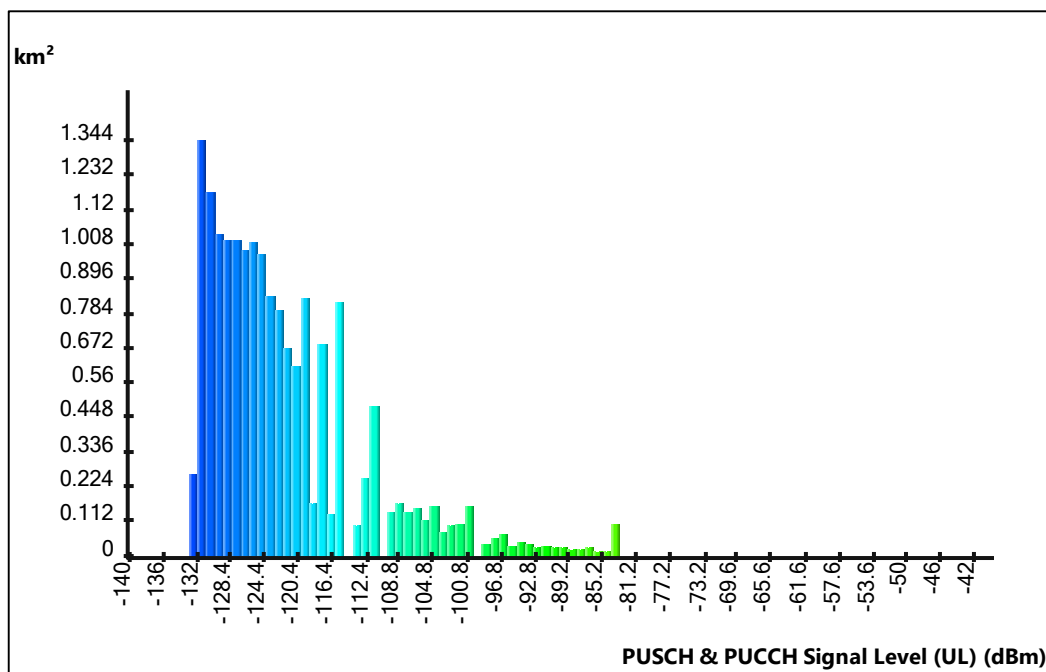
**Figure 3. 34:** prediction histogram of Effective Signal Analysis (DL) in LTE technology

### 3.5.1.5 Effective Signal Analysis (UL)

The following figures show the map and histogram prediction results of Effective Signal Analysis (UL) in LTE technology;



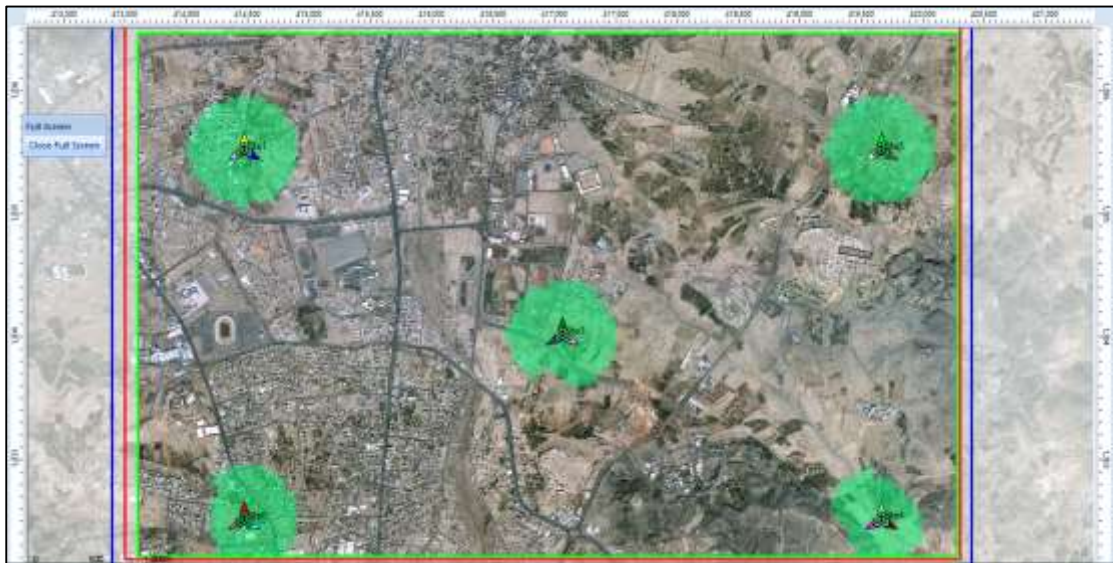
**Figure 3. 35:** prediction result of Effective Signal Analysis (UL) in LTE technology



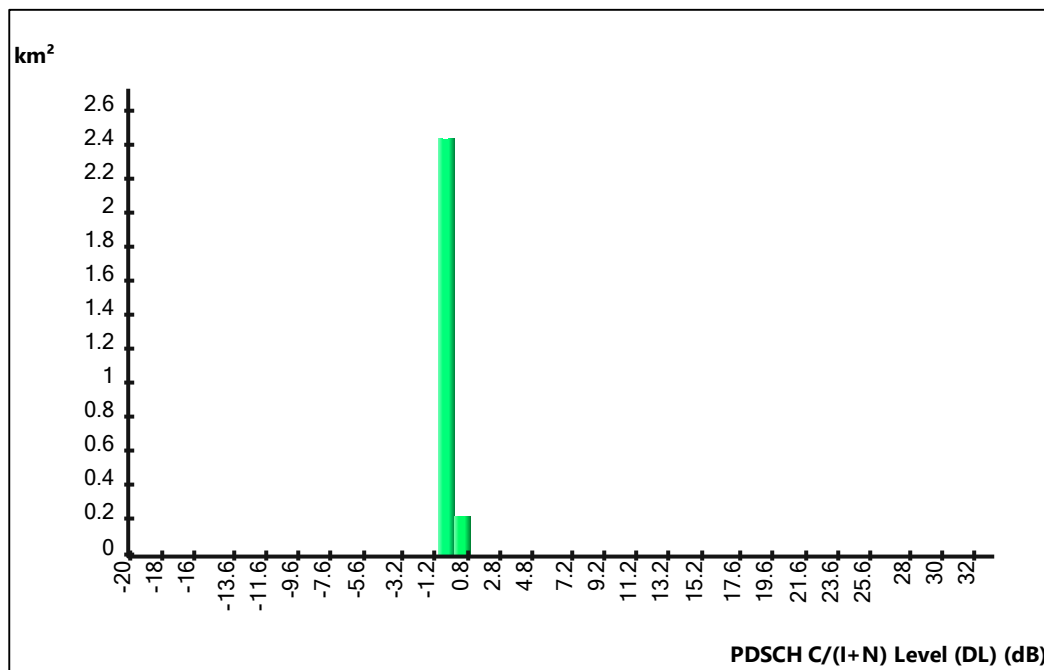
**Figure 3. 36:** prediction histogram of Effective Signal Analysis (UL) in LTE technology

### 3.5.1.7 Coverage by C/(I+N) Level (DL)

The following figures show the map and histogram prediction results of Coverage by C/(I+N) Level (DL) in LTE technology;



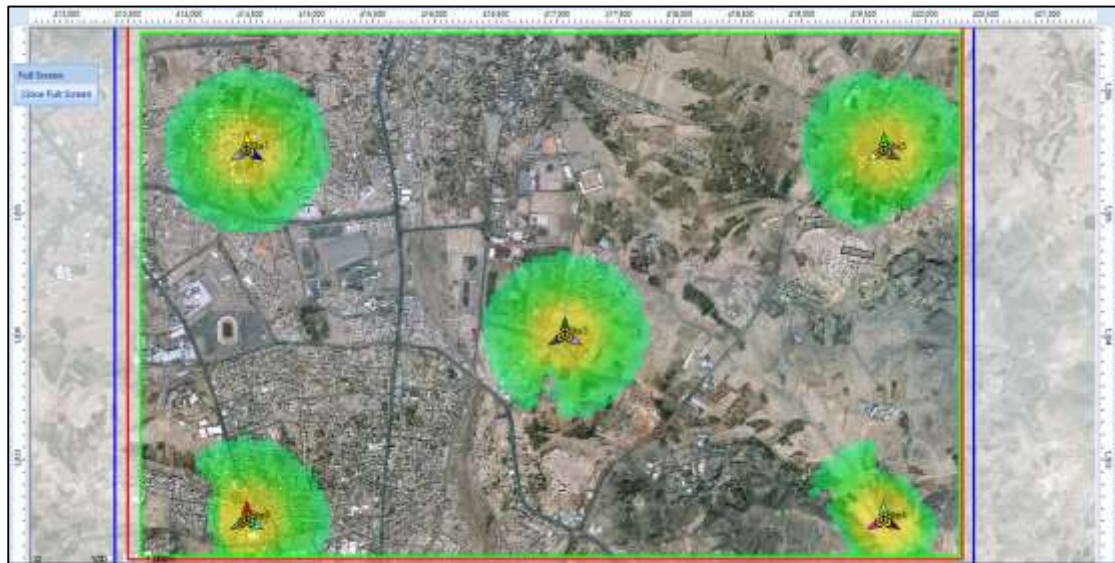
**Figure 3. 37:** prediction result of Coverage by C/(I+N) Level (DL) in LTE technology



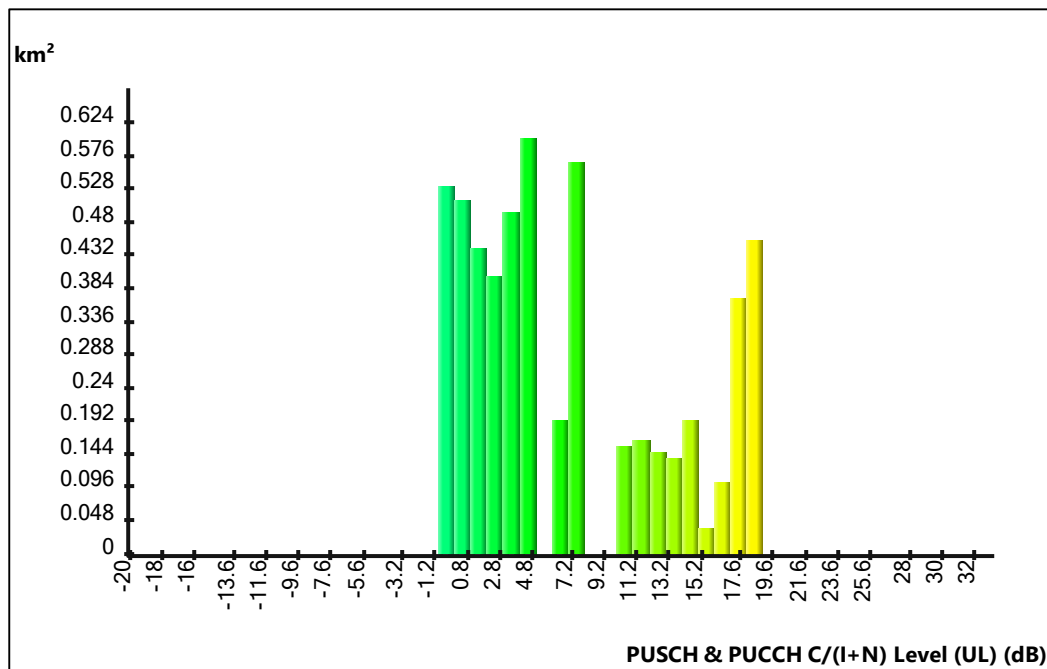
**Figure 3. 38:** prediction histogram of Coverage by C/(I+N) Level (DL) in LTE technology

### 3.5.1.8 Coverage by C/(I+N) Level (UL)

The following figures show the map and histogram prediction results of Coverage by C/(I+N) Level (UL) in LTE technology;



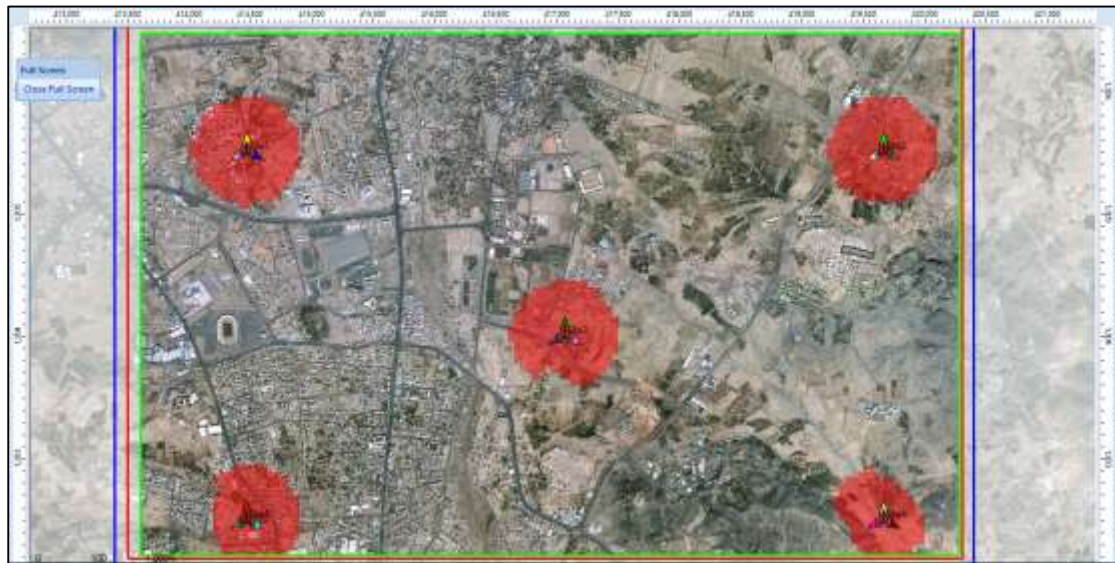
**Figure 3. 39:** prediction result of Coverage by C/(I+N) Level (UL) in LTE technology



**Figure 3. 40:** prediction histogram of Coverage by Coverage by C/(I+N) Level (UL) in LTE technology

### 3.5.1.9 Effective Service Area Analysis (DL+UL)

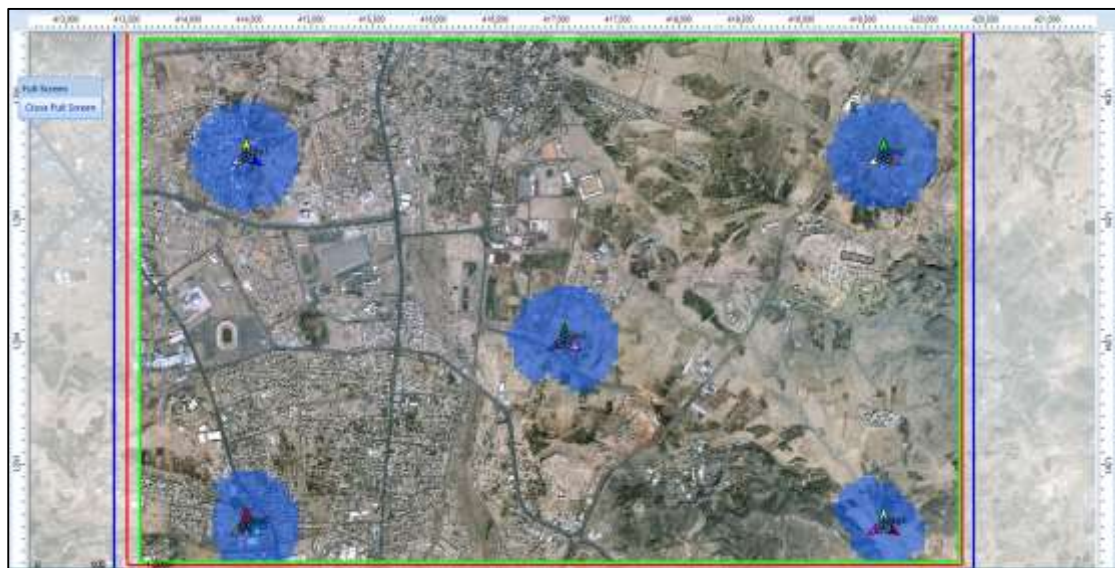
The following figure shows the prediction result of Effective Service Area Analysis (DL+UL) in LTE technology;



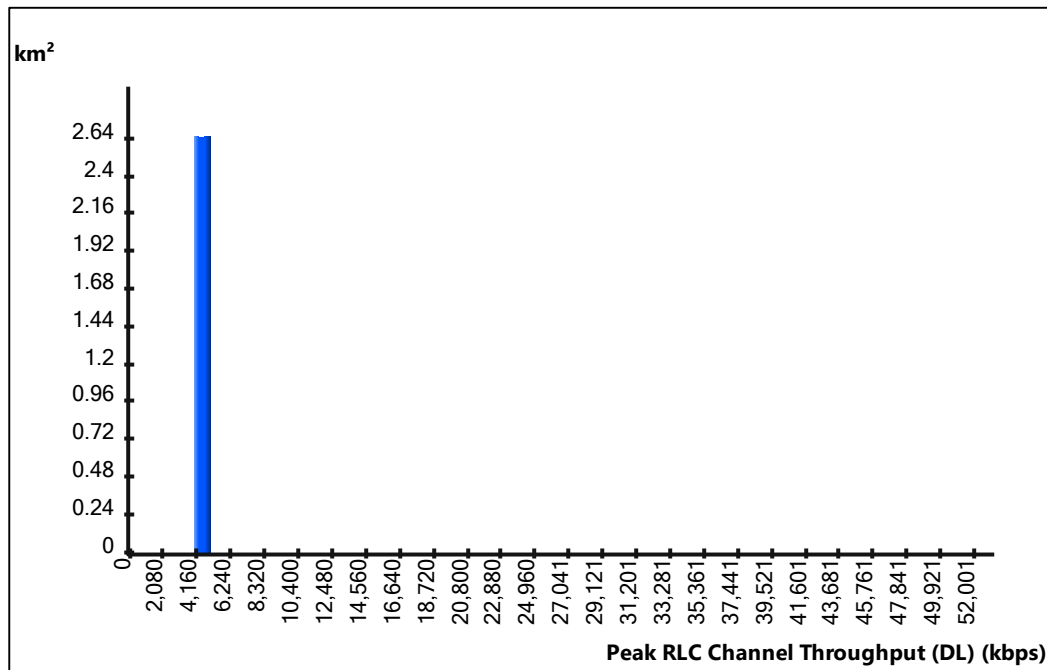
**Figure 3. 41:** prediction result of Effective Service Area Analysis (DL+UL) in LTE technology

### 3.5.1.10 Coverage by Throughput (DL)

The following figures show the map and histogram prediction results of Coverage by Throughput (DL) in LTE technology;



**Figure 3. 42:** prediction result of Coverage by Coverage by Throughput (DL) in LTE technology



**Figure 3. 43:** prediction histogram of Coverage by Throughput (DL) in LTE technology

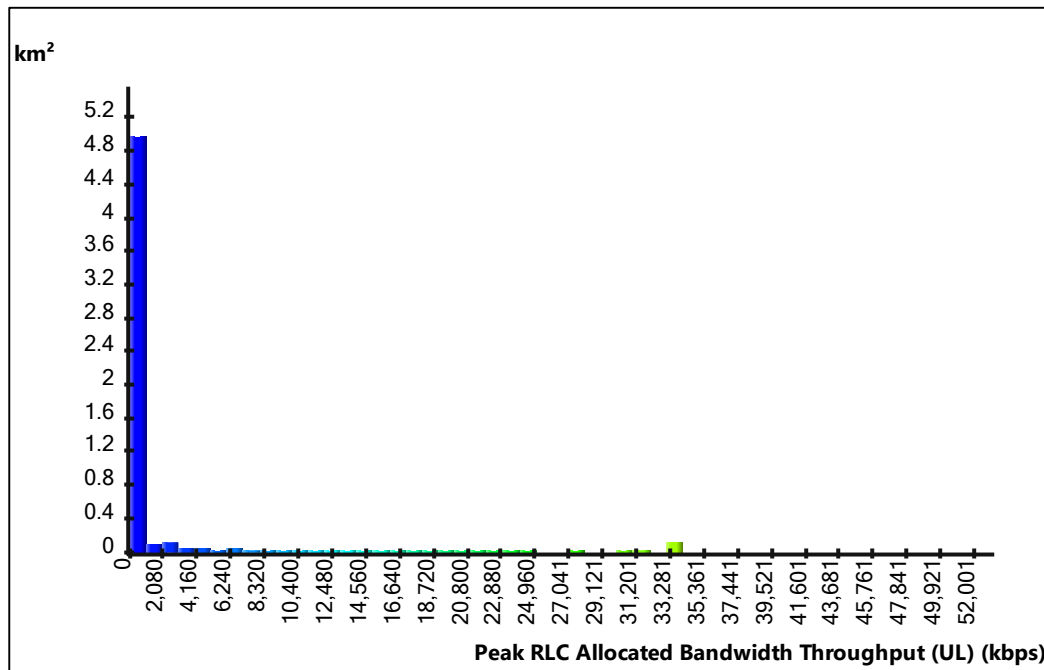
### 3.5.1.11 Coverage by Throughput (UL)

The following figures show the map and histogram prediction results of Coverage by Throughput (UL) in LTE technology;



**Figure 3. 44:** prediction result of Coverage by Throughput (UL) in LTE technology

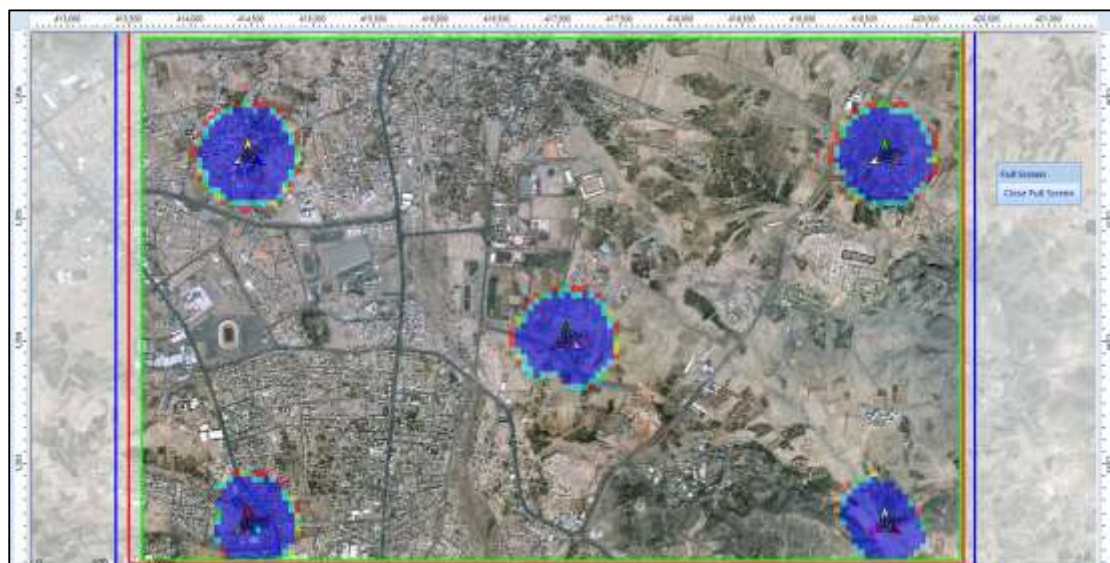




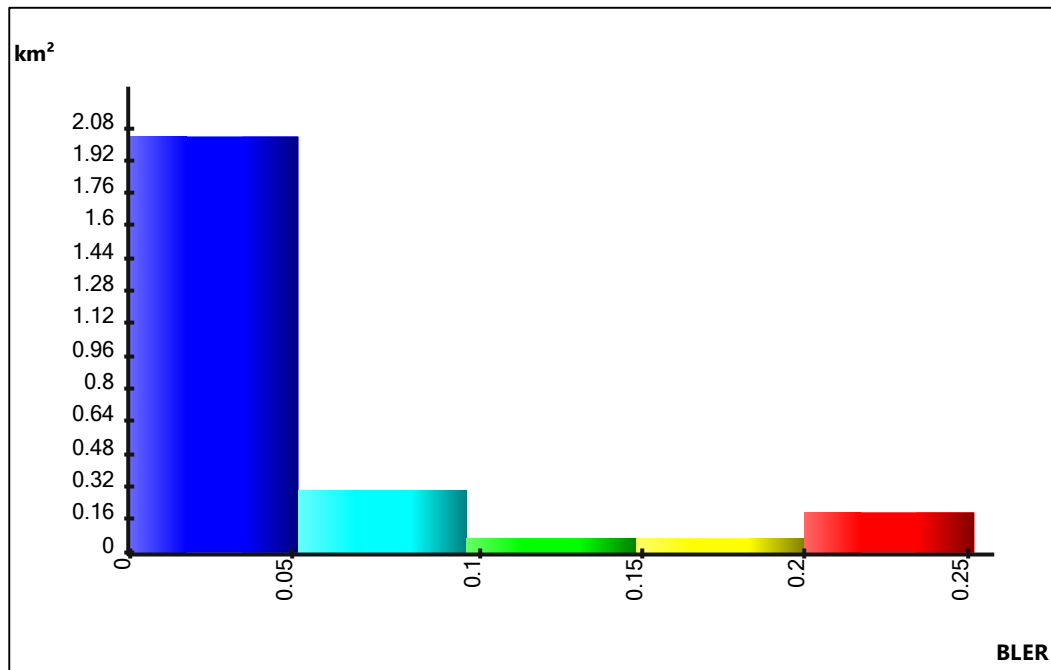
**Figure 3. 45:** prediction histogram of Coverage by Throughput (UL) in LTE technology

### 3.5.1.12 Coverage by Quality Indicator (DL)

The following figures show the map and histogram prediction results of Coverage by Quality Indicator (DL) in LTE technology;



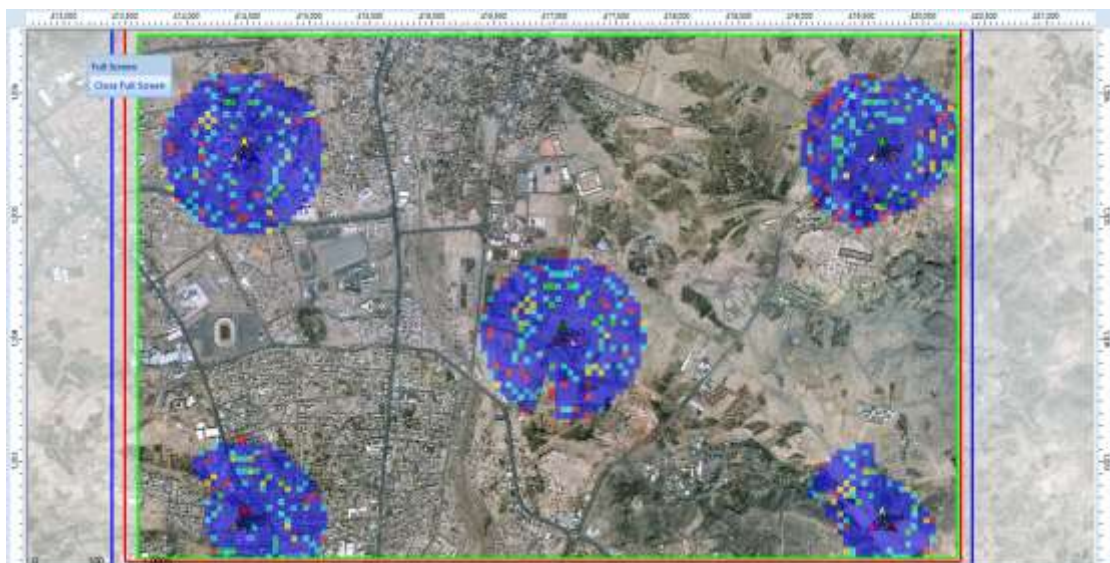
**Figure 3. 46:** prediction result of Coverage by Quality Indicator (DL) in LTE technology



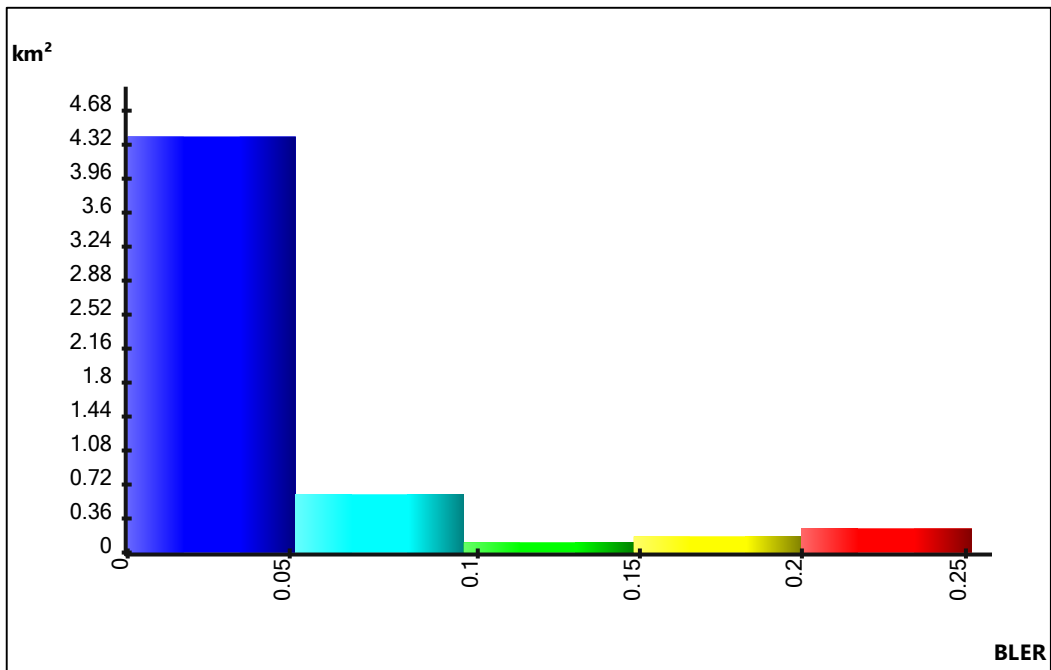
**Figure 3. 47:** prediction histogram of Coverage by Quality Indicator (DL) in LTE technology

### 3.5.1.13 Coverage by Quality Indicator (UL)

The following figures show the map and histogram prediction results of Coverage by Quality Indicator (UL) in LTE technology;



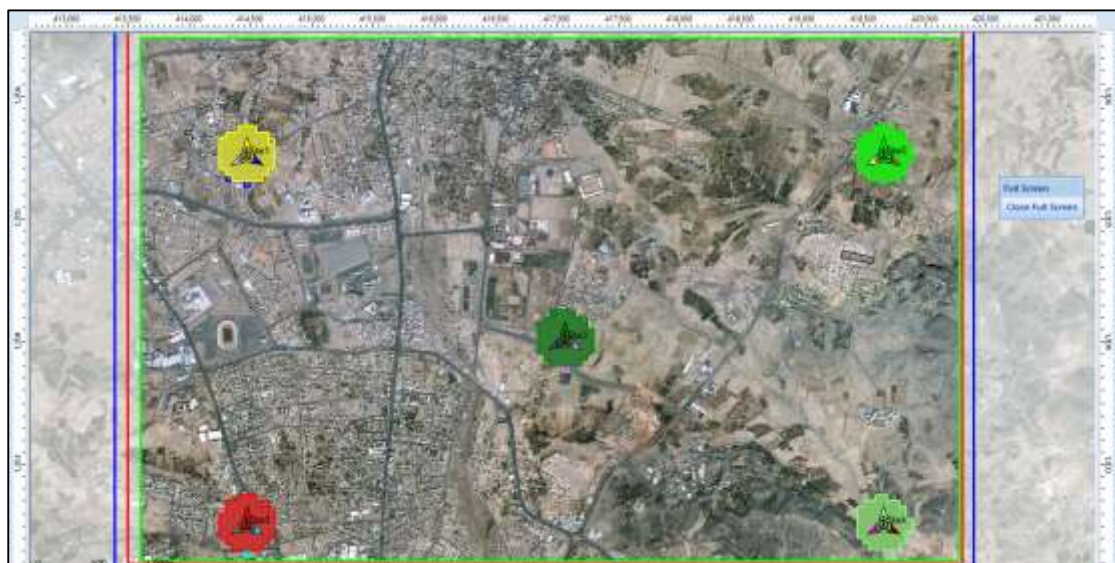
**Figure 3. 48:** prediction result of Coverage by Quality Indicator (UL) in LTE technology



**Figure 3. 49:** prediction histogram of Coverage by Quality Indicator (UL) in LTE technology

### 3.5.1.14 Cell Identifier Collision Zones (DL)

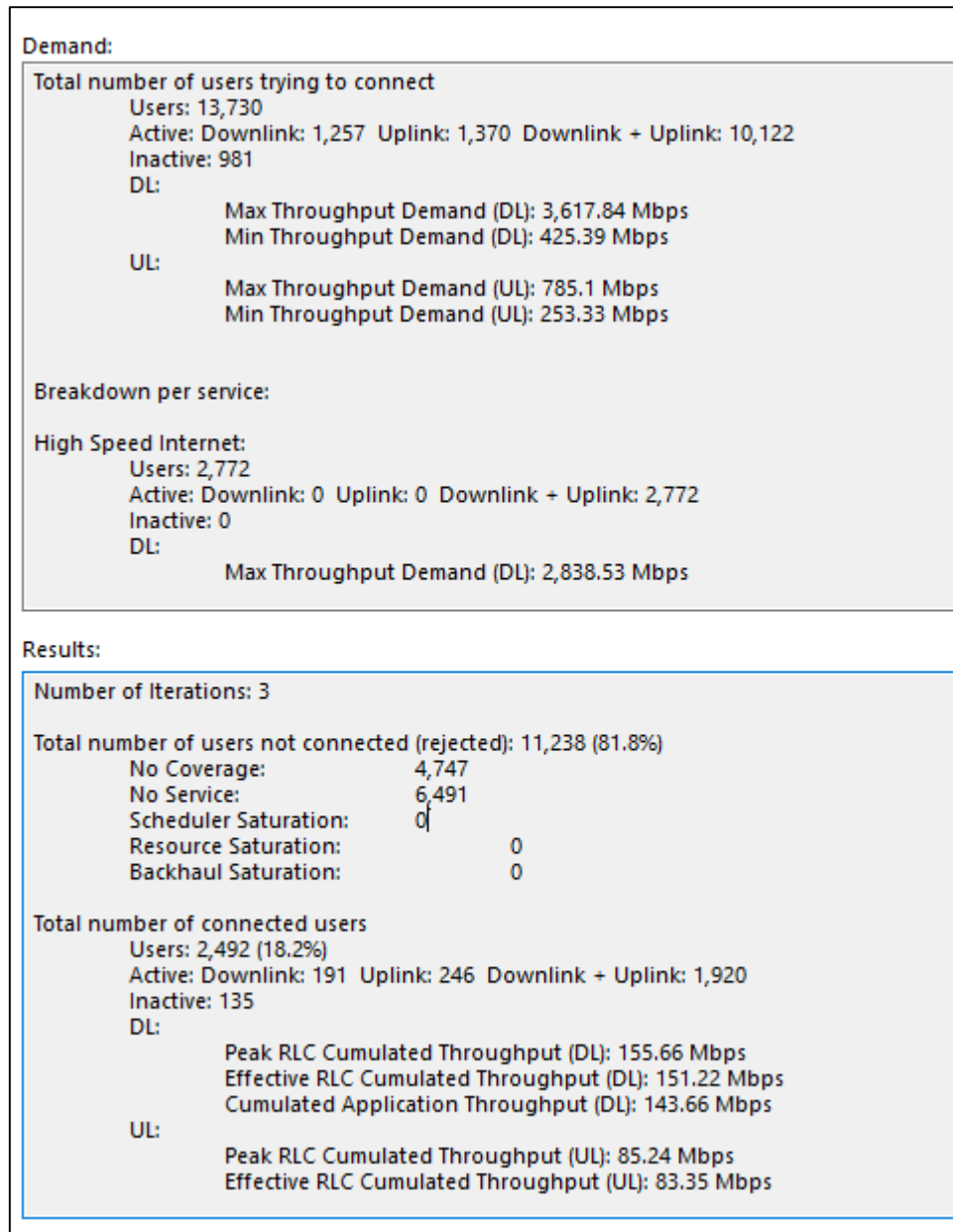
The following figure shows the prediction result of Cell Identifier Collision Zones (DL) in LTE technology;



**Figure 3. 50:** prediction result of Cell Identifier Collision Zones (DL) in LTE technology

### 3.5.1.14 Initial Simulation Demands and Results

The following figure shows the Initial Simulation Demands and Results of LTE technology;



**Figure 3. 51:** Initial Simulation Demands and Results of LTE technology

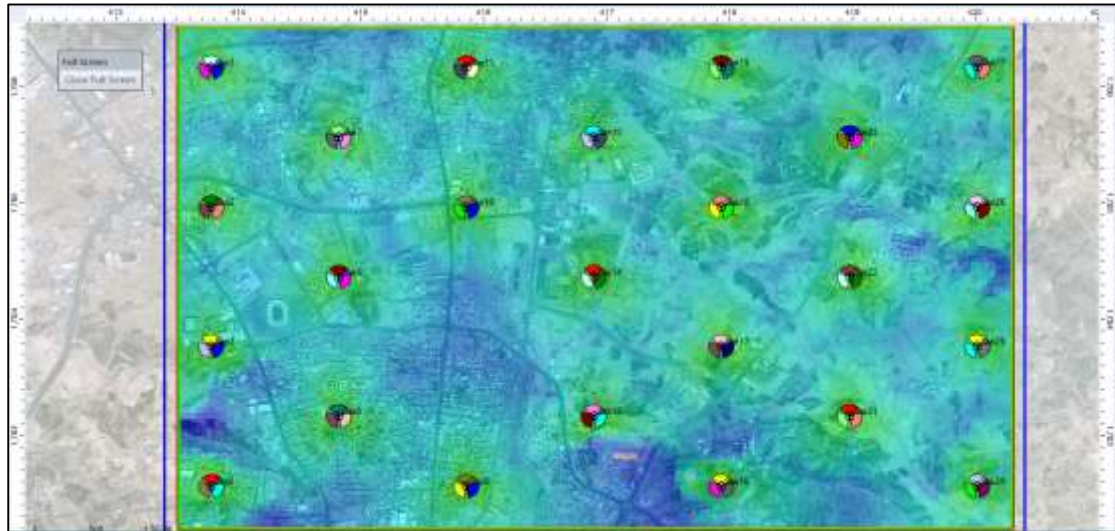
### 3.5.2 5G NR

This part presents the initial prediction and simulation results of 5G NR technology that have been gotten according to the initial settings that have been set.

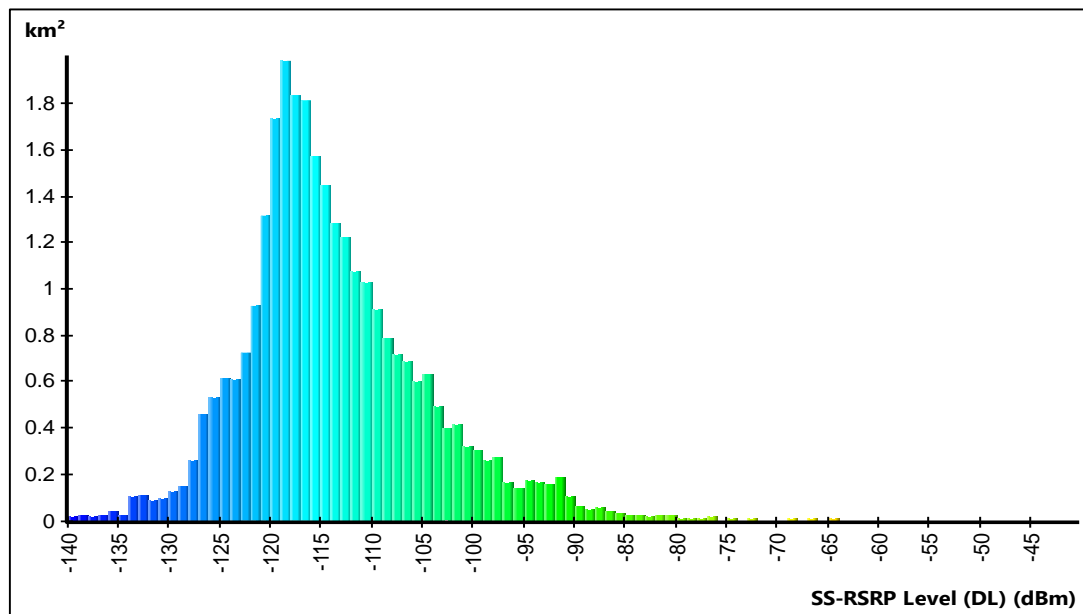
This part presents the initial prediction and simulation results of LTE technology that have been gotten according to the initial settings that have been set.

### 3.5.2.1 5G NR: Downlink Coverage

The following figures show the map and histogram prediction results of 5G NR: Downlink Coverage in 5G NR technology;



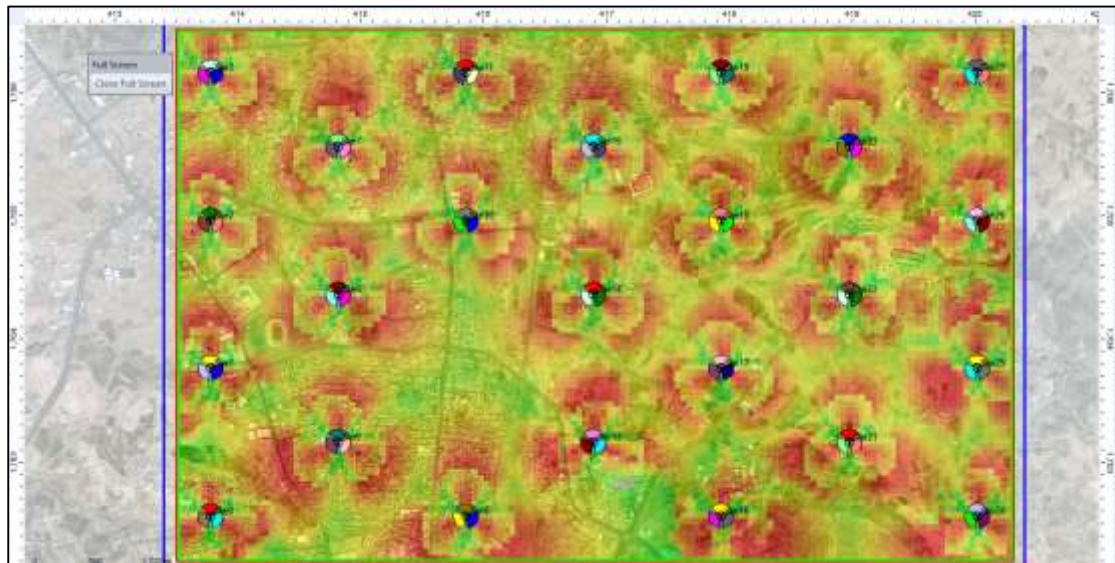
**Figure 3. 52:** prediction result of Coverage by Transmitter (DL) in 5G NR technology



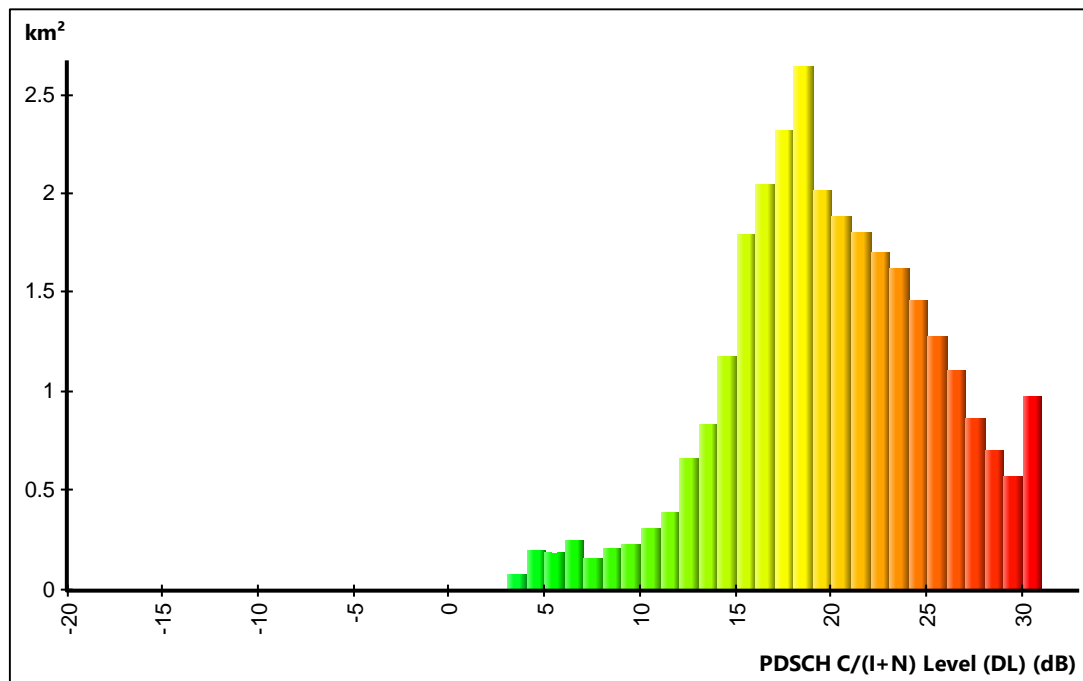
**Figure 3. 53:** 5G NR: Downlink Coverage in 5G NR design

### 3.5.2.2 5G NR: Downlink Quality

The following figures show the map and histogram prediction results of Coverage by Signal Level (DL) in 5G NR technology;



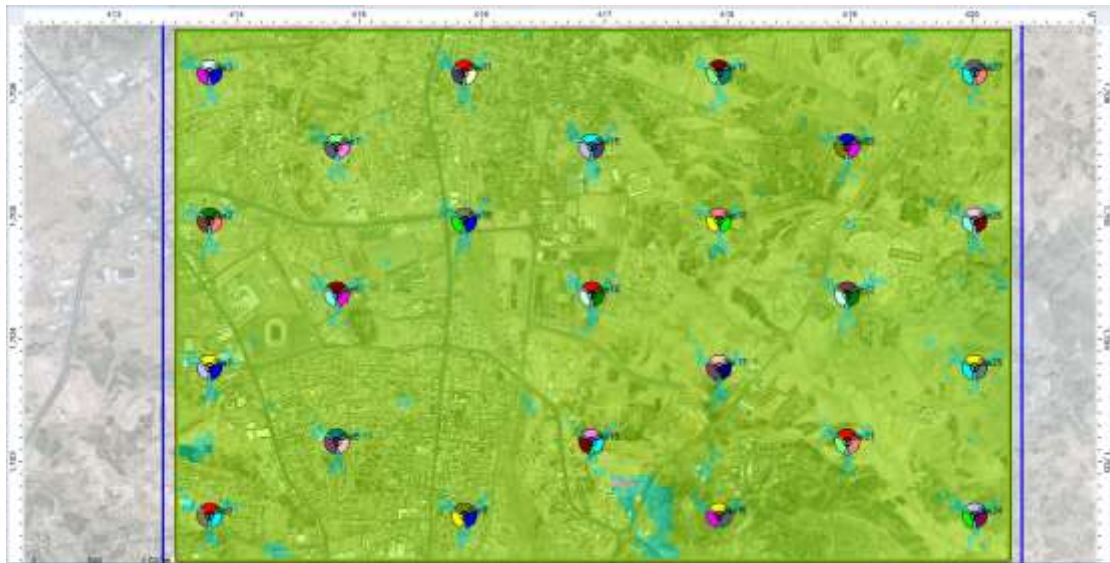
**Figure 3. 54:** prediction result of 5G NR: Downlink Quality in 5G NR technology



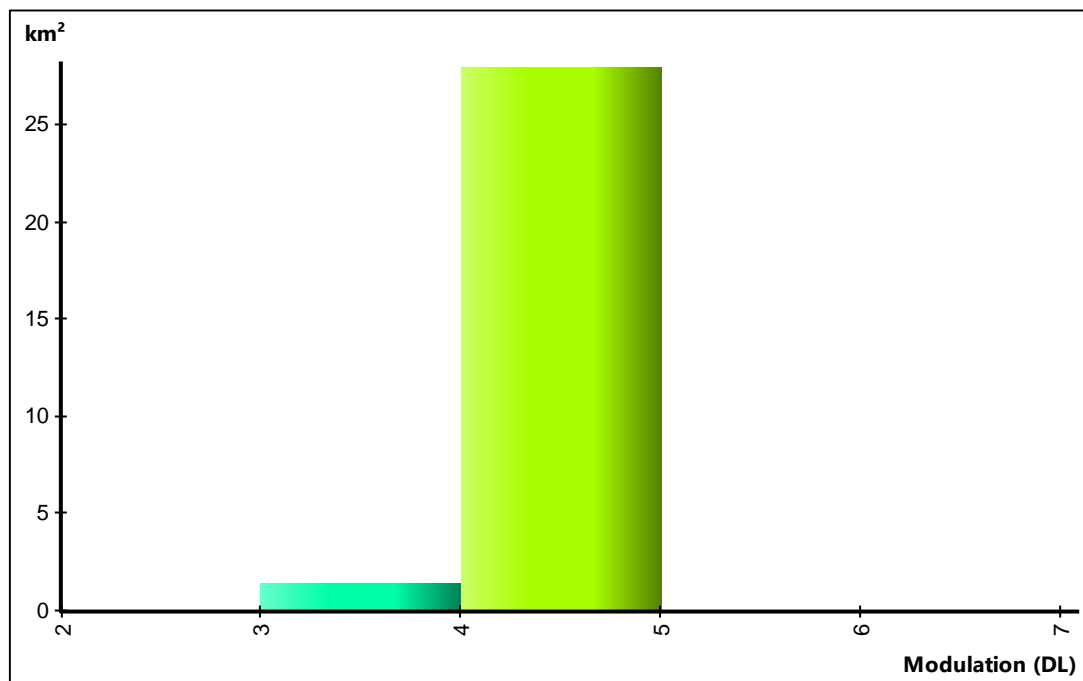
**Figure 3. 55:** prediction histogram of 5G NR: Downlink Quality in 5G NR technology

### 3.5.2.3 5G NR: Downlink Service Areas

The following figures show the map and histogram prediction results of 5G NR: Downlink Service Areas in 5G NR technology;



**Figure 3. 56:** prediction result of 5G NR: Downlink Service Areas in 5G NR technology



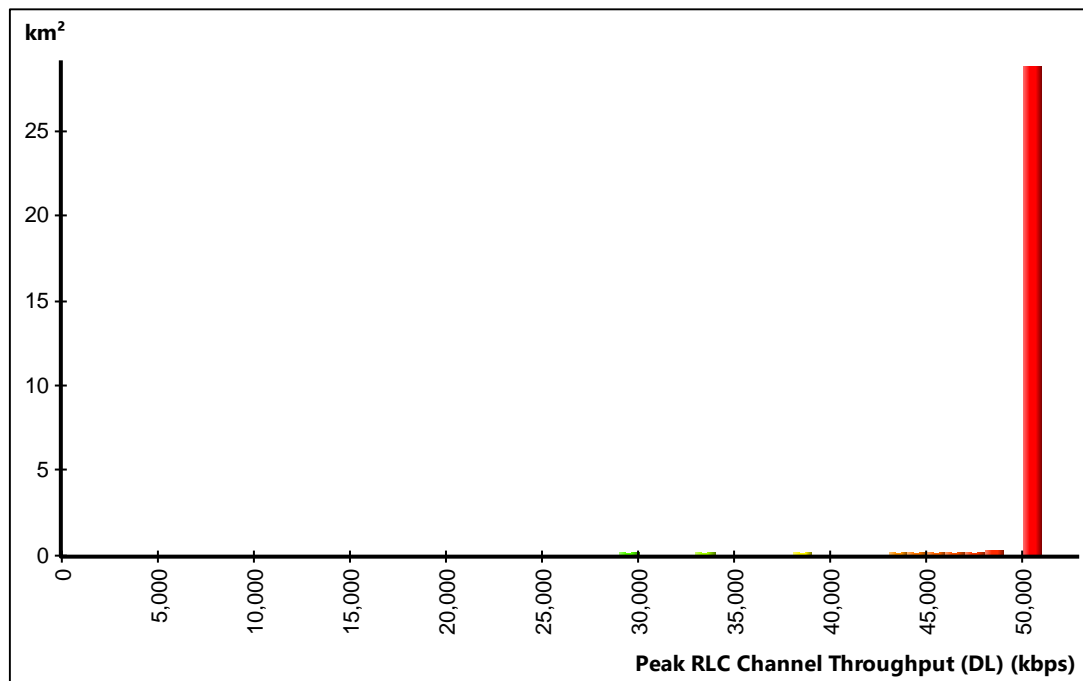
**Figure 3. 57:** prediction histogram of 5G NR: Downlink Service Areas in 5G NR technology

### 3.5.2.4 5G NR: Downlink Capacity

The following figures show the map and histogram prediction results of 5G NR: Downlink Capacity in 5G NR technology;



**Figure 3. 58:** prediction result of 5G NR: Downlink Capacity in 5G NR technology

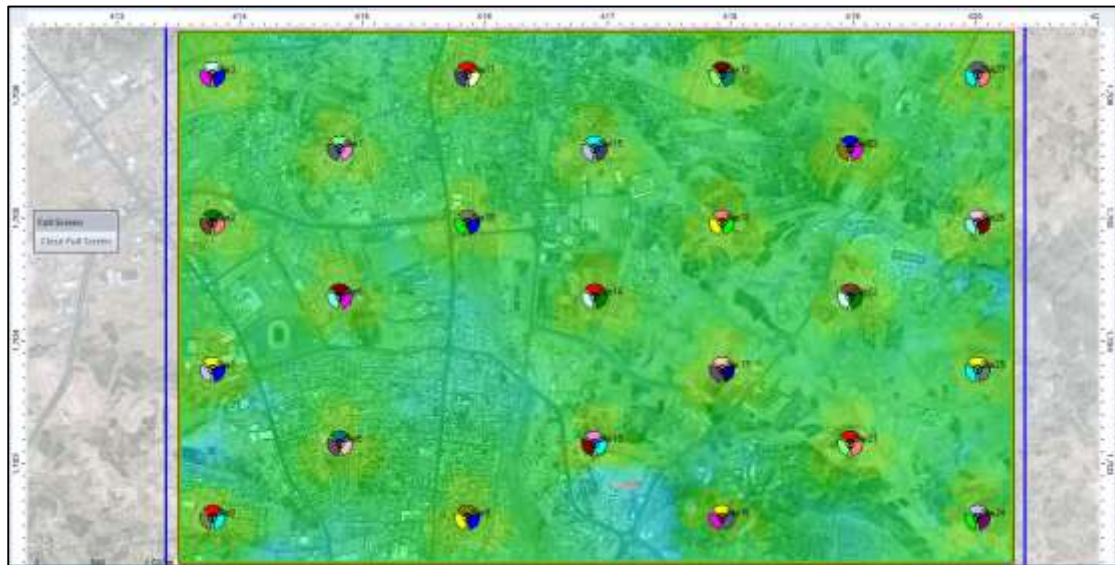


**Figure 3. 59:** prediction histogram of 5G NR: Downlink Capacity in 5G NR technology

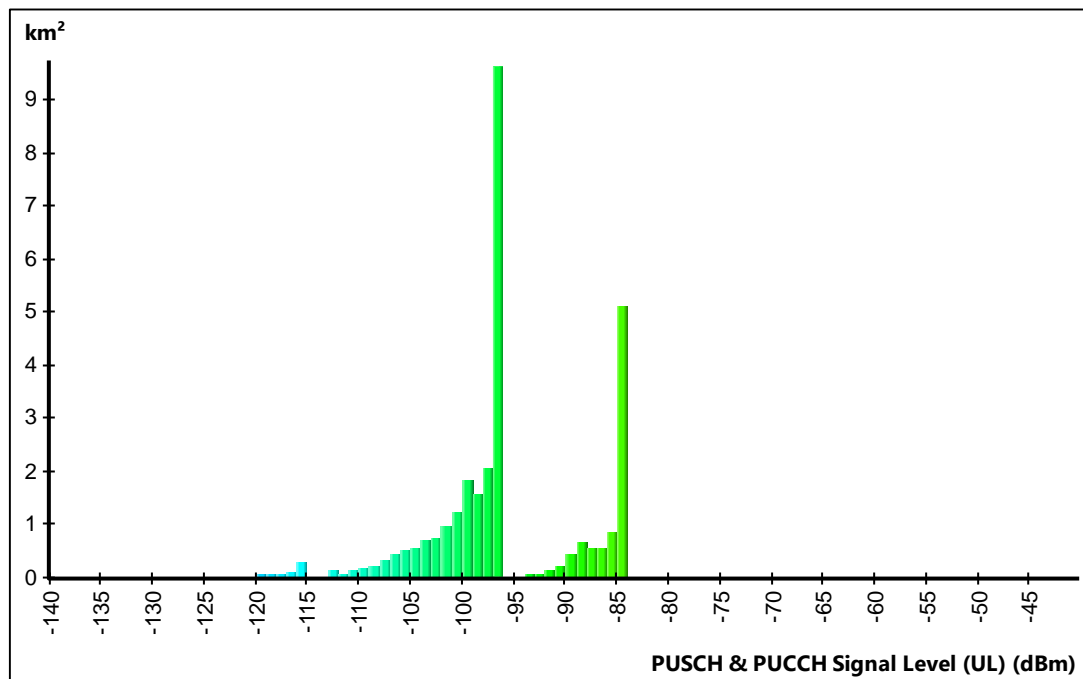


### 3.5.2.5 5G NR: Uplink Coverage

The following figures show the map and histogram prediction results of 5G NR: Uplink Coverage in 5G NR technology;



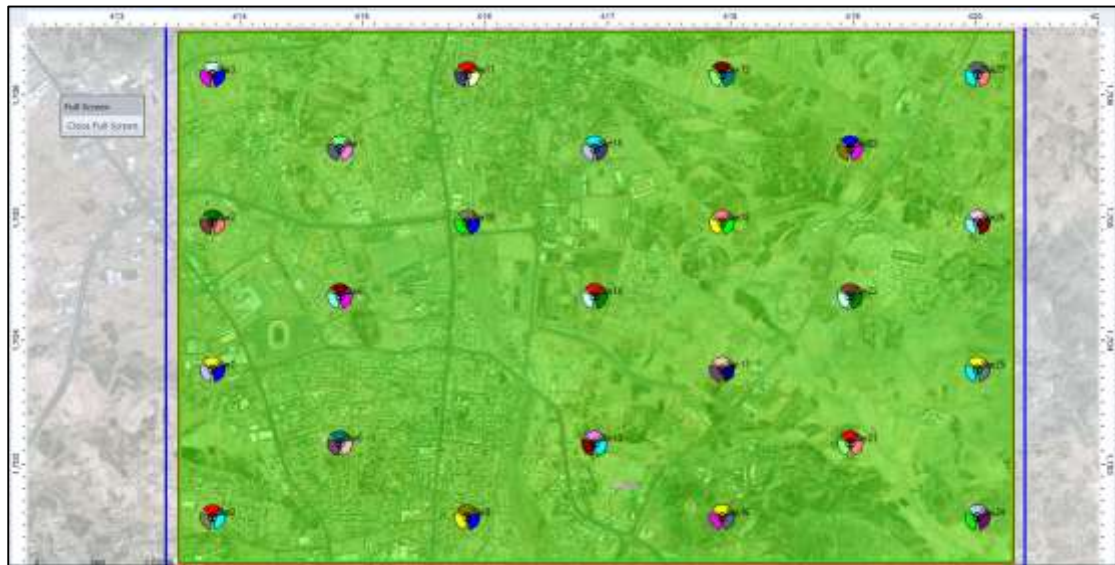
**Figure 3. 60:** prediction result of 5G NR: Uplink Coverage in 5G NR technology



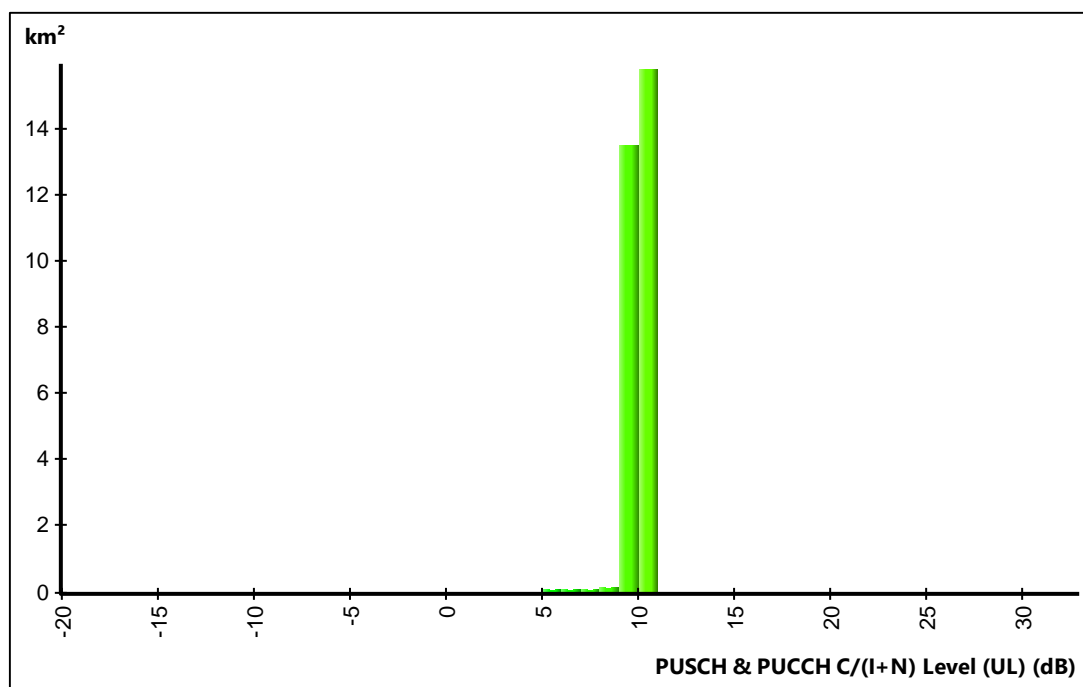
**Figure 3. 61:** prediction histogram of 5G NR: Uplink Coverage in 5G NR technology

### 3.5.2.7 5G NR: Uplink Quality

The following figures show the map and histogram prediction results of 5G NR: Uplink Quality in 5G NR technology;



**Figure 3. 62:** prediction result of 5G NR: Uplink Quality in 5G NR technology



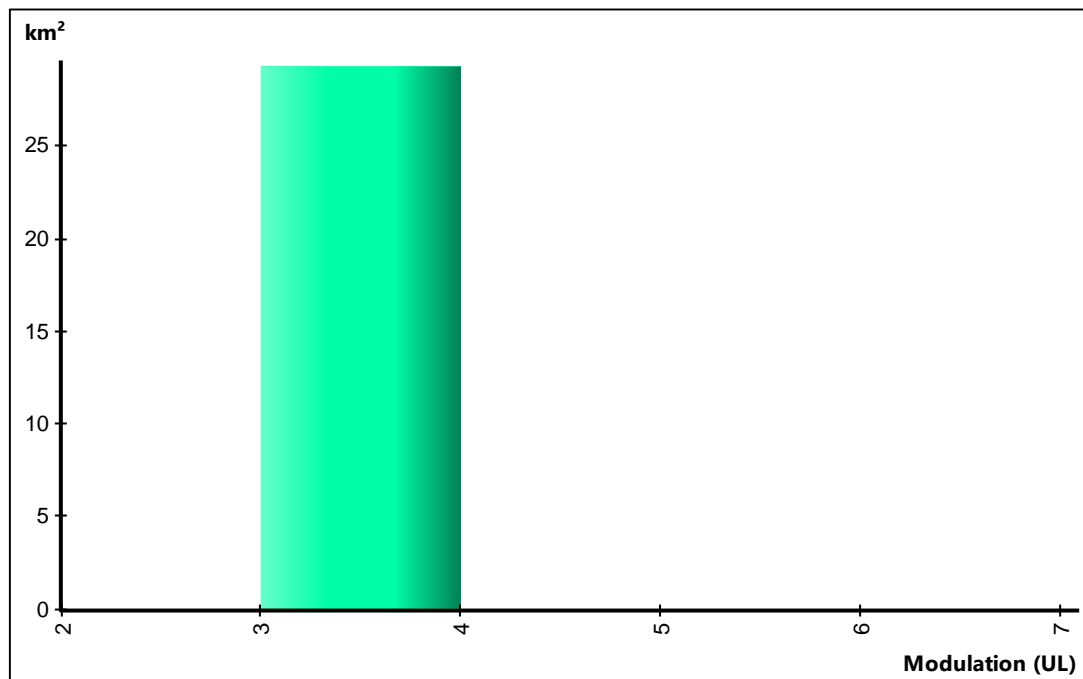
**Figure 3. 63:** prediction histogram of 5G NR: Uplink Quality in 5G NR technology

### 3.5.2.8 5G NR: Uplink Service Areas

The following figures show the map and histogram prediction results of 5G NR: Uplink Service Areas in 5G NR technology;



**Figure 3. 64:** prediction result of 5G NR: Uplink Service Areas in 5G NR technology



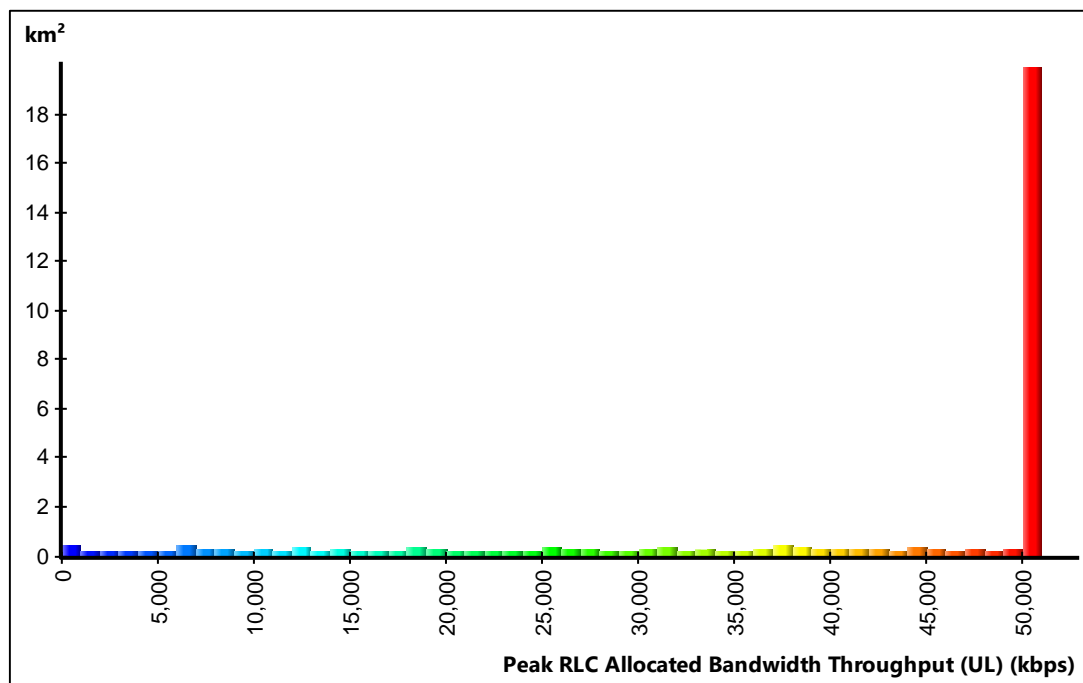
**Figure 3. 65:** prediction histogram of 5G NR: Uplink Service Areas in 5G NR technology

### 3.5.2.9 5G NR: Uplink Capacity

The following figures show the map and histogram prediction results of 5G NR: Uplink Capacity in 5G NR technology;



**Figure 3. 66:** prediction result of 5G NR: Uplink Capacity in 5G NR technology



**Figure 3. 67:** prediction histogram of 5G NR: Uplink Capacity in 5G NR technology

### 3.5.2.10 Effective Service Area Analysis (DL+UL)

The following figures show the map result of Effective Service Area Analysis (DL+UL) in 5G NR technology;



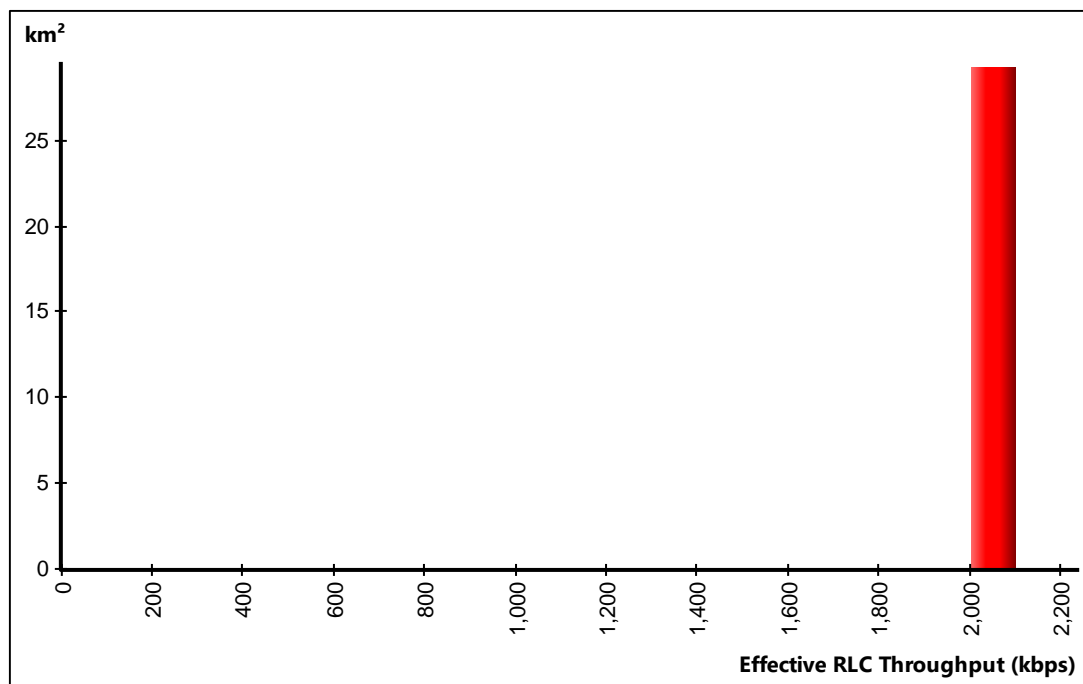
**Figure 3. 68:** prediction result of Effective Service Area Analysis (DL+UL) in 5G NR technology

### 3.5.2.11 Coverage by Throughput (DL)

The following figures show the map and histogram prediction results of Coverage by Throughput (DL) in 5G NR technology;



**Figure 3. 69:** prediction result of Coverage by Throughput (DL) in 5G NR technology



**Figure 3. 70:** prediction histogram of Coverage by Throughput (DL) in 5G NR technology

### 3.5.2.14 Initial Simulation Demands and Results

The following figure shows the Initial Simulation Demands and Results of 5G NR technology;

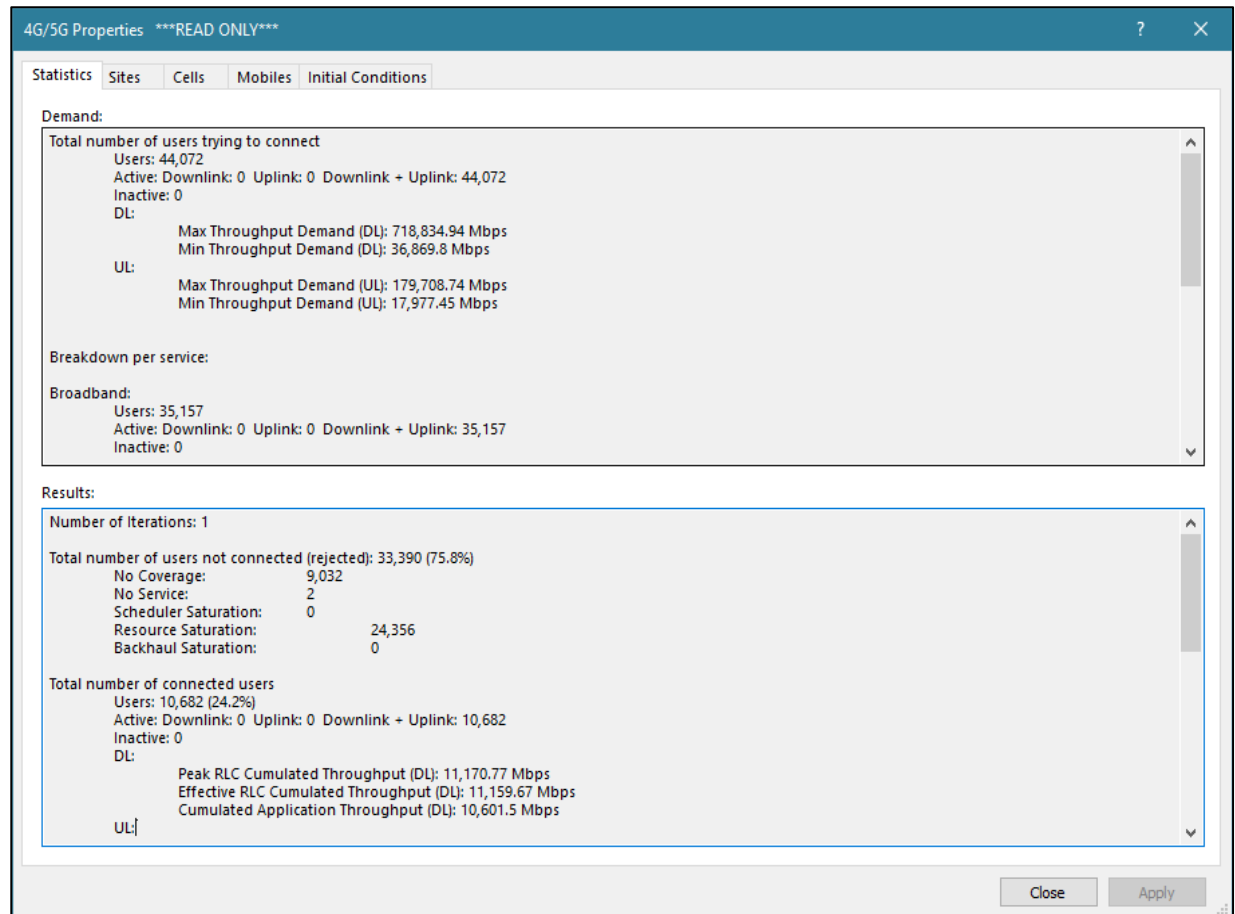


Figure 3. 71: Initial Simulation Demands and Results of 5G NR technology

## 3.6 Optimization Procedure

This part presents the optimization procedure that has been done in the current study through a series of changes and modifications that led eventually to better results. Each modification that led to a noticeable enhancement is explained and followed by a screenshot of the new simulation, which is a result of the preceding modification. Sometimes the result gets worse after some modifications; hence, the modification in this case is declined, and another modification is adopted to get the optimum performance;

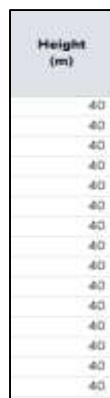
### 3.6.1 LTE

This part presents the optimization procedure of LTE technology that has been done in the current study through a series of changes and modifications that led eventually to better results.

#### 3.6.1.1 Increasing Transmitter Height

An increase of the transmitter height led to a significant enhancement of the results. Each transmitter of the 15 transmitters got a new height value. The value height was set to 40m. This value means the height of the antenna above the ground. This is added to the altitude of the site as given by the DTM. If the remote antenna is situated on a building, the height entered must include the height of building.

The following figure shows the new value which has been set to all transmitters;

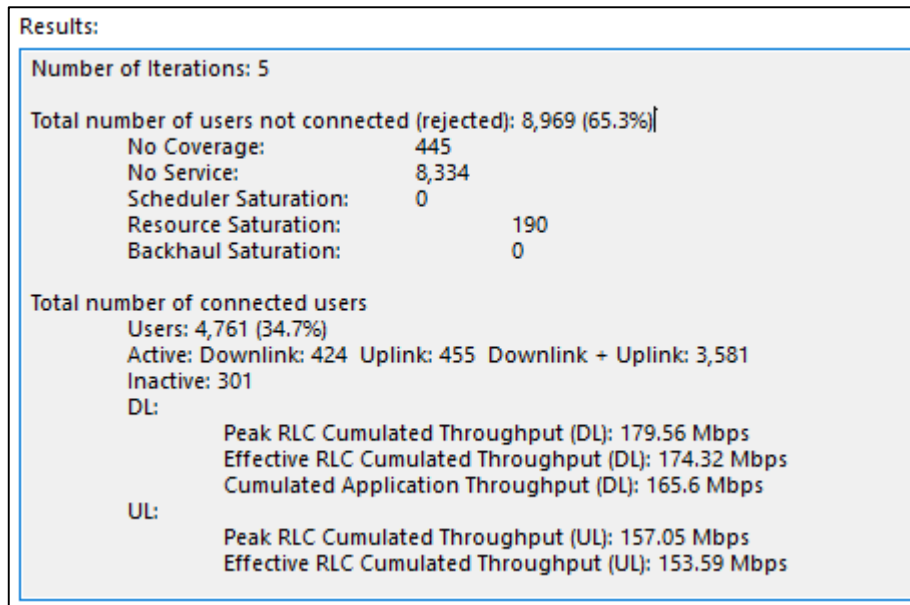


Height (m)
40
40
40
40
40
40
40
40
40
40
40
40
40
40
40
40

**Figure 3. 72:** Setting the transmitter height to 40m in LTE design

The following figure shows the result that has been obtained due to the previously mentioned modification that has led to an optimization of performance;



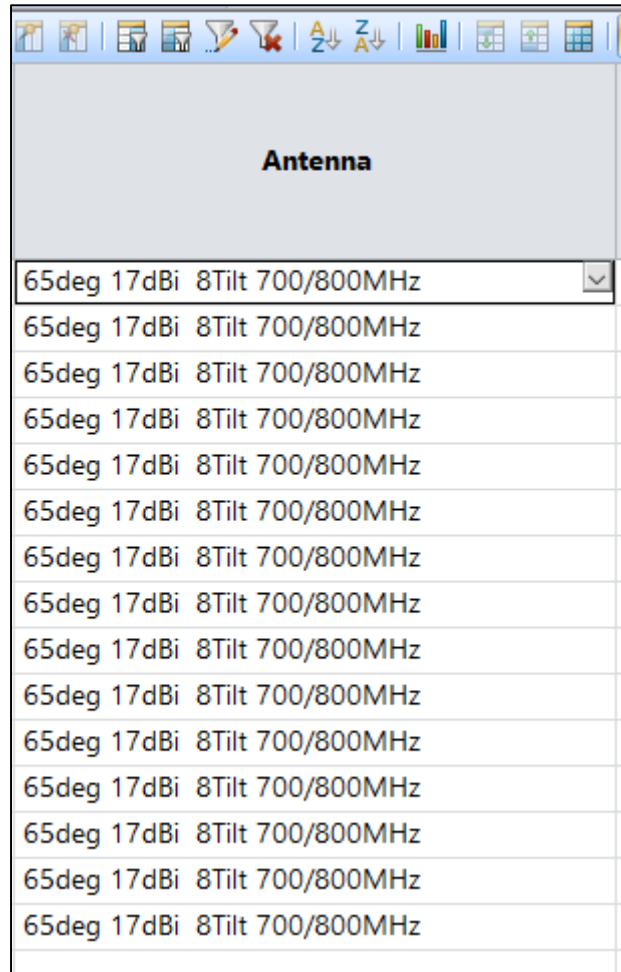


**Figure 3. 73:** Simulation results after increasing transmitter height to 40m

It is noticed that there is an optimization of simulation results due to the increase of transmitters height. The percentage of connected users has increased from 18.2% to 34.7%, and this means there is an optimization of 16.5% of the total performance.

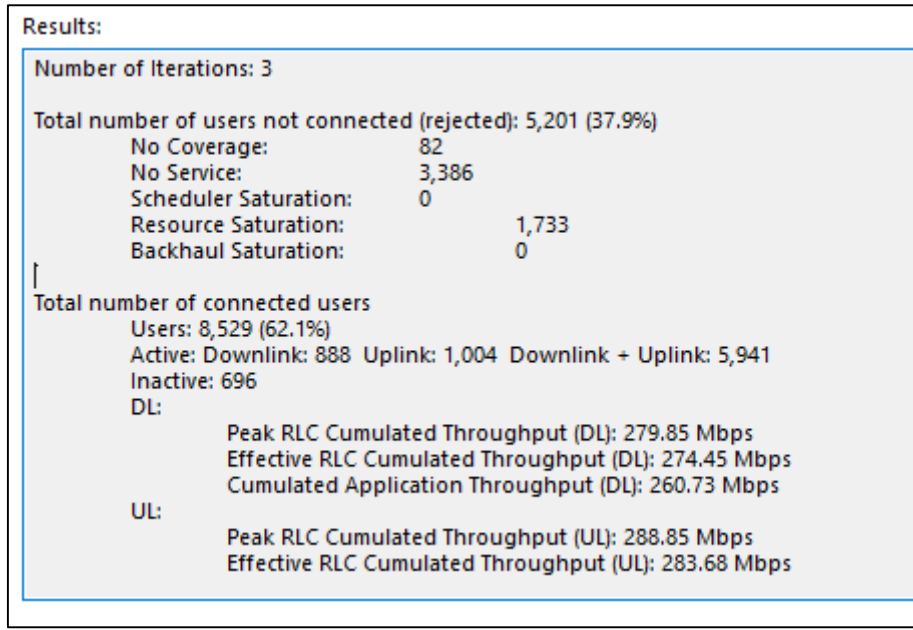
### 3.6.1.2 Changing type of Antenna

After many tests we found out that it is necessary to change the type of the antenna used in the transmitter properties to be (65deg 17dBi 8Tilt 700/800MHz). This change led into a significant improvement of the results obtained after the change. The following figure shows the new settings of antenna type in the transmitters table;



**Figure 3. 74:** setting the antenna type of the transmitter

The following figure shows the result that has been obtained due to the previously mentioned modification that has led to an optimization of performance;

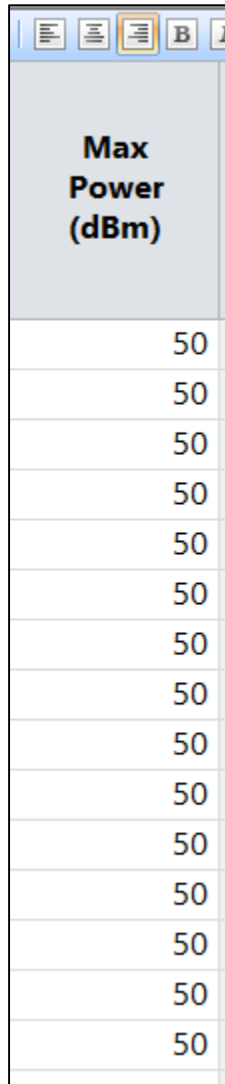


**Figure 3. 75:** Simulation results after changing the type of antenna

It is noticed that there is an optimization of simulation results due to the change of antenna type. The percentage of connected users has increased from 34.7% to 62.1%, and this means there is an optimization of 27.4% of the total performance.

**3.6.1.3 Increasing Max Power Limit**

After many tests, we found out that it is necessary to increase the limit of max power within each cell. Increasing the max power to 50dBm led to a significant improvement of the results obtained after increasing the max power value in the cells table. This value is basically the cell’s maximum transmission power. The following figure shows the new settings of max power in the cells table;

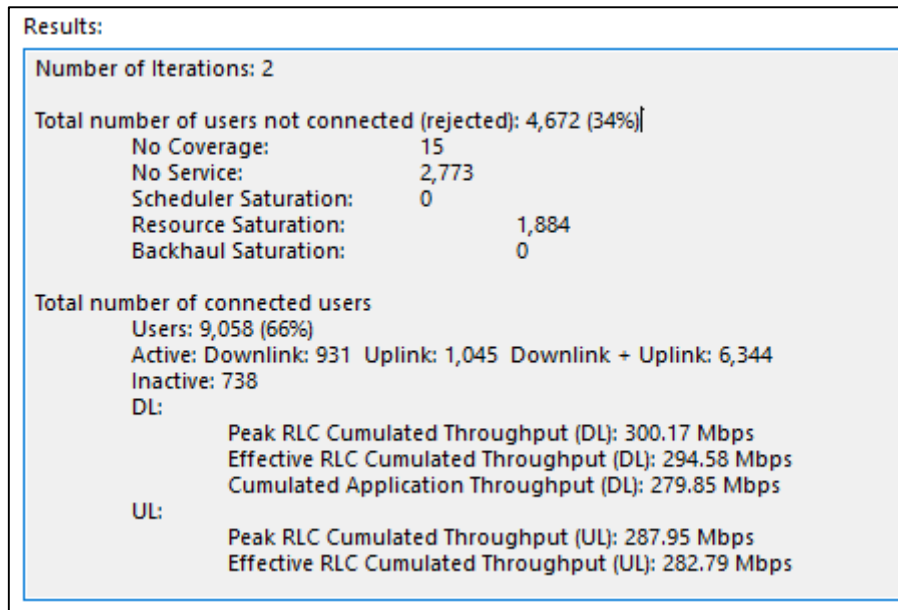


The image shows a vertical column in a spreadsheet application. The top cell is shaded grey and contains the text "Max Power (dBm)". Below this, there are 15 rows, each containing the number "50". The spreadsheet interface includes a toolbar at the top with icons for undo, redo, bold, and italic.

Max Power (dBm)
50
50
50
50
50
50
50
50
50
50
50
50
50
50
50
50

**Figure 3. 76:** setting new values of max power

The following figure shows the result that has been obtained due to the previously mentioned modification that has led to an optimization of performance;

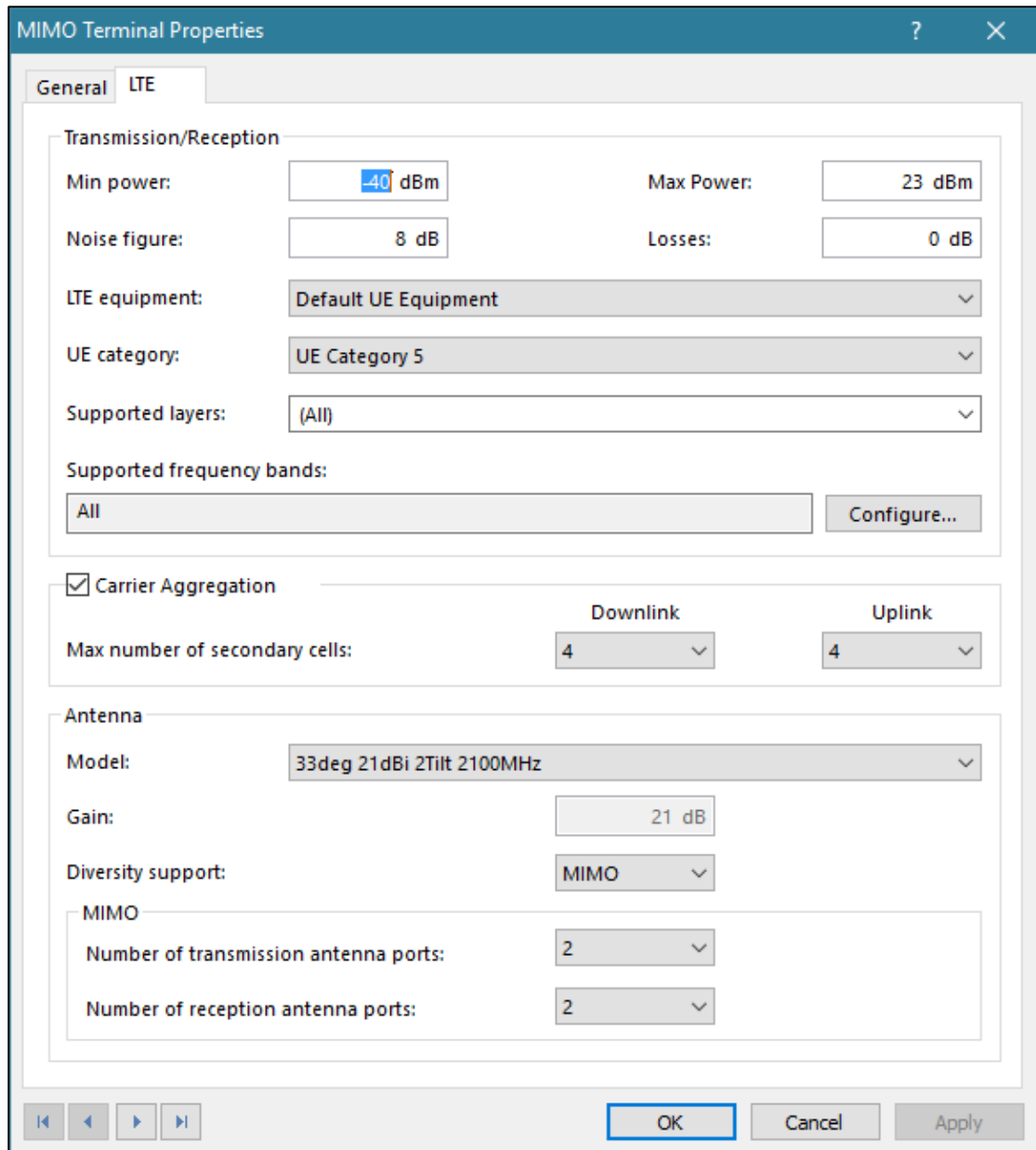


**Figure 3. 77:** Simulation results after increasing max power of cells

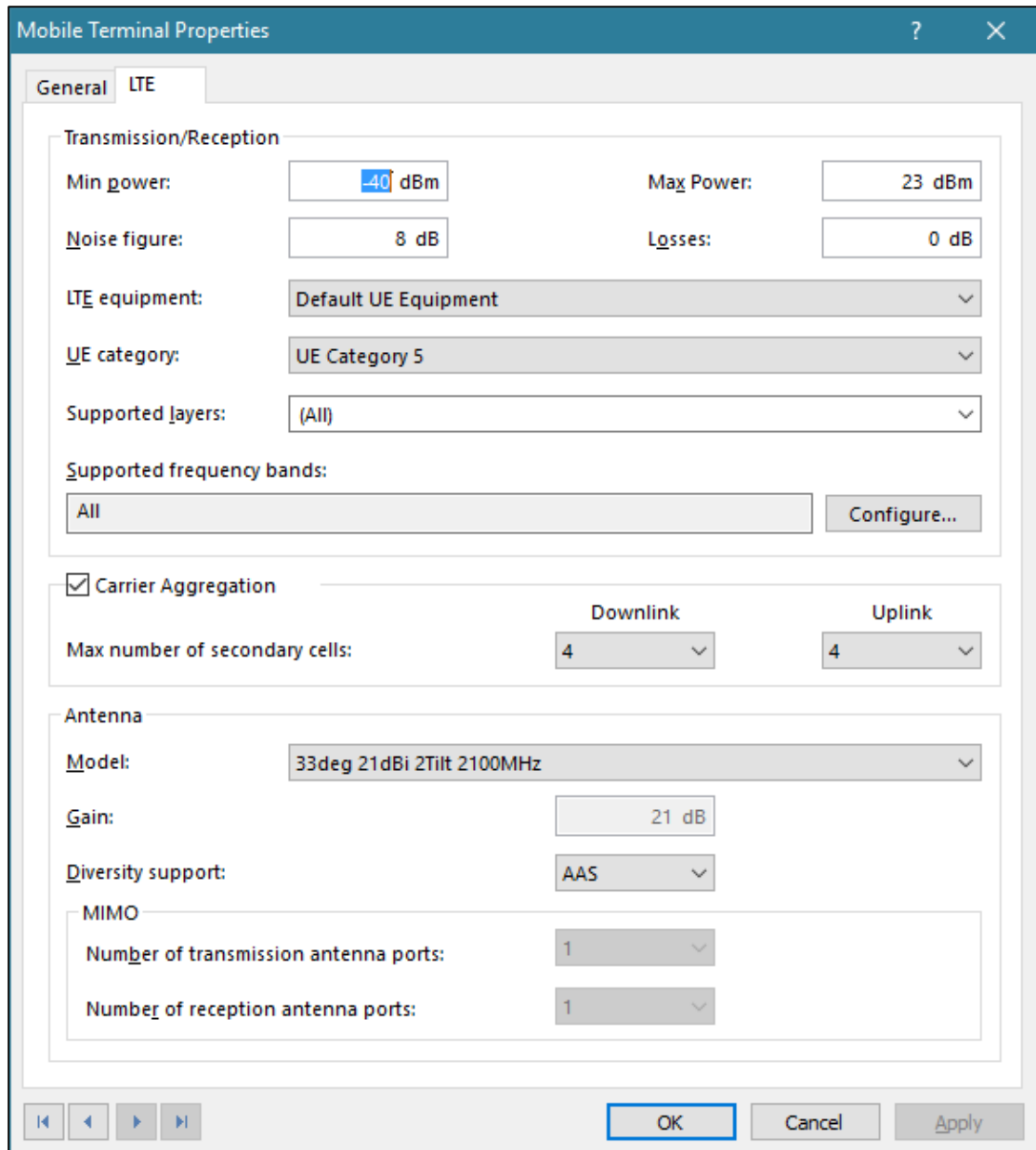
It is noticed that there is an optimization of simulation results due to the increase of max power of cells. The percentage of connected users has increased from 62.1% to 66%, and this means there is an optimization of 3.9% of the total performance.

#### 3.6.1.4 Modifying User Terminals

After many tests, it was found out that it is necessary to make some modifications on the UE terminals. Those modifications include allowing carrier aggregation, and adopting a different type of antenna with a better gain of 21dB, and using MIMO technique on one type of UE terminals which is name MIMO, and the other terminal that is named Mobile Terminal was left without enabling the MMIO feature on it. The following figures show the new settings of the tow terminals;

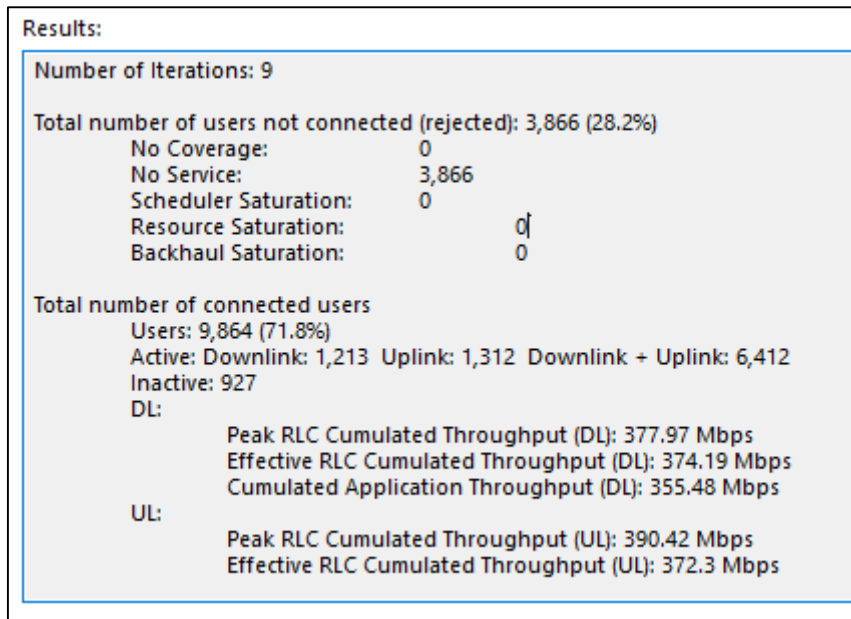


**Figure 3. 78:** Modified settings of MIMO terminal in the LTE design



**Figure 3. 79:** Modified settings of Mobile terminal in the LTE design

The following figure shows the result that has been obtained due to the previously mentioned modification that has led to an optimization of performance;



**Figure 3. 80:** Simulation results after the modifications of UE terminals

It is noticed that there is an optimization of simulation results due to the increase of max power of cells. The percentage of connected users has increased from 66% to 71.8%, and this means there is an optimization of 5.8% of the total performance.

### 3.6.1.6 Modifying Azimuth Angle and Mechanical Down-tilt of Transmitters

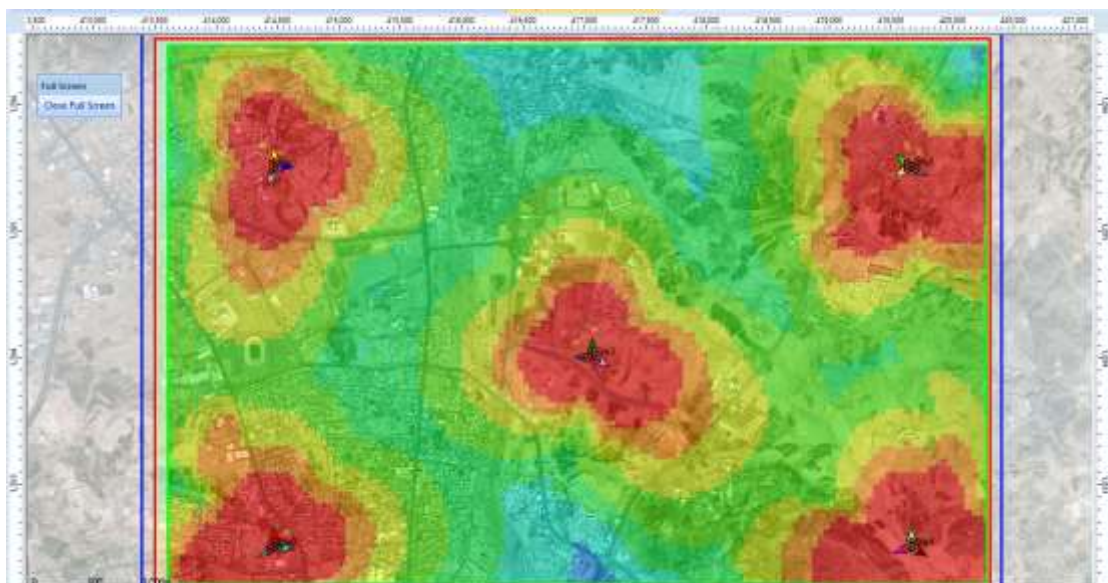
After many tests, it was found out that it is necessary to make some modifications on the Azimuth Angle and Mechanical Down-tilt of Transmitters. The changes of azimuth angle was based on what was observed on the map in term of signal level prediction results. Some transmitters were shifted to new angles to cover areas with low signal levels, and for the same purpose the mechanical down-tilt has been change from 0 to  $-5^{\circ}$ . This allowed more users to get better signal level and this means they became able to use higher borers with a better modulation scheme and coding rate, and this made the able to use different services effectively. The following figure shows the new settings of azimuth angle and mechanical down-tilt;



Azimuth (°)	Mechanical Downtilt (°)	Additional Electrical Downtilt (°)
0	-5	0
88	-5	0
240	-5	0
0	-5	0
90	-5	0
197	-5	0
0	-5	0
120	-5	0
272	-5	0
0	-5	0
120	-5	0
253	-5	0
311	-5	0
120	-5	0
240	-5	0

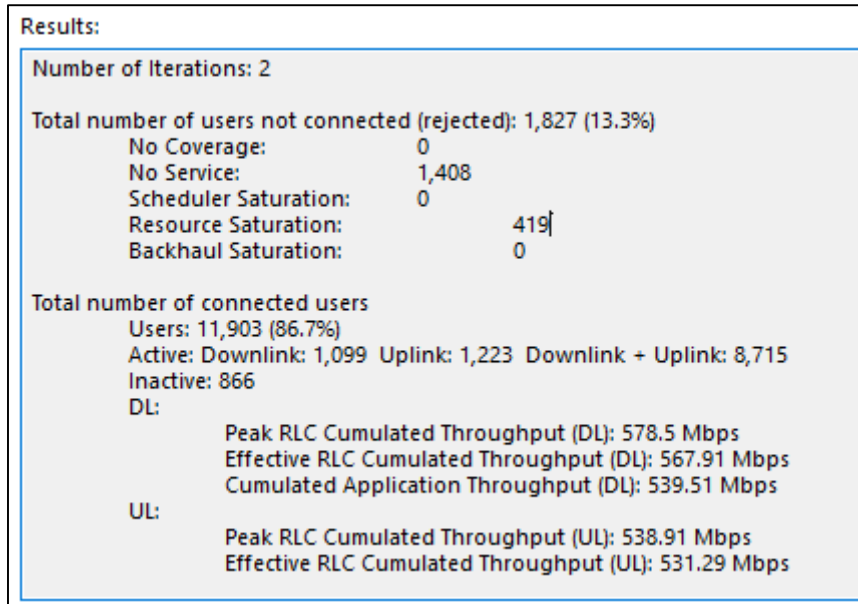
**Figure 3. 81:** Modified settings of Azimuth Angle and Mechanical Down-tilt of Transmitters

The following figure shows the studied area with the signal level prediction results after the modification of azimuth angle and mechanical down-tilt of transmitters;



**Figure 3. 82:** the studied area with the signal level prediction results after the modification of azimuth angle and mechanical down-tilt of transmitters

The following figure shows the result that has been obtained due to the previously mentioned modification that has led to an optimization of performance;



**Figure 3. 83:** Simulation results after the modifications of azimuth angle and mechanical down-tilt of transmitters in LTE design

It is noticed that there is an optimization of simulation results due to the increase of max power of cells. The percentage of connected users has increased from 71.8% to 86.7%, and this means there is an optimization of 14.9% of the total performance.

### 3.6.1.7 Modifying Frequency Band and the number of co-scheduled MU-MIMO

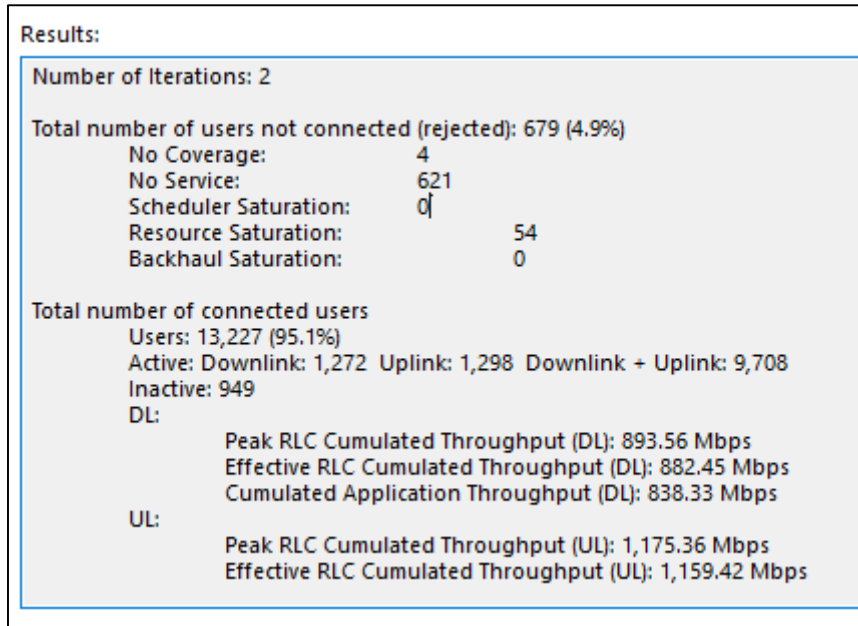
After many tests, it was found out that it is necessary to make some modifications on the Frequency Band and the number of co-scheduled MU-MIMO. The change of frequency band was based on what was observed on the frequency bands listed in a separated table within the software. The number of co-scheduled MU-MIMO refers to the average number of MU-MIMO users that share the same resources on the downlink and uplink. In downlink throughput coverage predictions, cell capacity is multiplied by this gain on pixels where MU-MIMO is used. The following figure shows the

new settings of Frequency Band and the number of co-scheduled MU-MIMO;

Frequency Band	Number of co-scheduled MU-MIMO users (DL)	Number of co-scheduled MU-MIMO users (UL)
E-UTRA Band 1 - 20MHz	5	5
E-UTRA Band 1 - 20MHz	5	5
E-UTRA Band 1 - 20MHz	5	5
E-UTRA Band 1 - 20MHz	5	5
E-UTRA Band 1 - 20MHz	5	5
E-UTRA Band 1 - 20MHz	5	5
E-UTRA Band 1 - 20MHz	5	5
E-UTRA Band 1 - 20MHz	5	5
E-UTRA Band 1 - 20MHz	5	5
E-UTRA Band 1 - 20MHz	5	5
E-UTRA Band 1 - 20MHz	5	5
E-UTRA Band 1 - 20MHz	5	5
E-UTRA Band 1 - 20MHz	5	5
E-UTRA Band 1 - 20MHz	5	5
E-UTRA Band 1 - 20MHz	5	5
E-UTRA Band 1 - 20MHz	5	5
E-UTRA Band 1 - 20MHz	5	5

**Figure 3. 84:** Modified settings of Frequency Band and the number of co-scheduled MU-MIMO

The following figure shows the result that has been obtained due to the previously mentioned modification that has led to an optimization of performance;



**Figure 3. 85:** Simulation results after the modifications Frequency Band and the number of co-scheduled MU-MIMO in LTE design

It is noticed that there is an optimization of simulation results due to the increase of max power of cells. The percentage of connected users has increased from 86.7% to 95.1%, and this means there is an optimization of 8.4% of the total performance.

This result is somewhat acceptable in a practical environment, and it was found out that it is too difficult to go further and get better results no matter how many other changes are done, so we stop at this level of optimization that has been accomplished.

### 3.6.2 5G NR

This part presents the optimization procedure of 5G NR technology that has been done in the current study through a series of changes and modifications that led eventually to better results.

### 3.6.1.1 Decreasing Transmitter Height

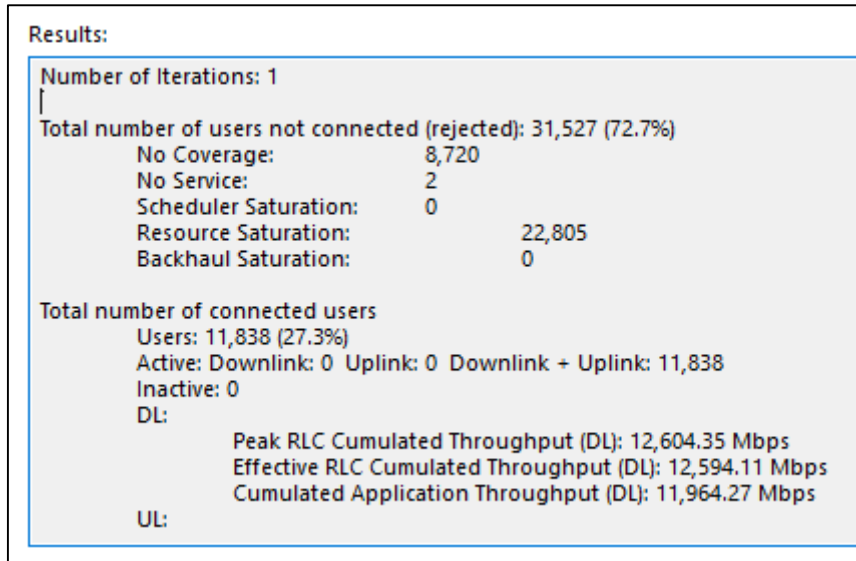
A decrease of the transmitter height led to a significant enhancement of the results. Each transmitter of the 15 transmitters got a new height value. The value height was decreased from 30m to 20m. This value means the height of the antenna above the ground. This is added to the altitude of the site as given by the DTM. If the remote antenna is situated on a building, the height entered must include the height of building.

The following figure shows the new value which has been set to all transmitters;

Height (m)
20
20
20
20
20
20
20
20
20
20
20
20
20
20
20

**Figure 3. 86:** Setting the transmitter height to 20m in 5G NR design

The following figure shows the result that has been obtained due to the previously mentioned modification that has led to an optimization of performance;

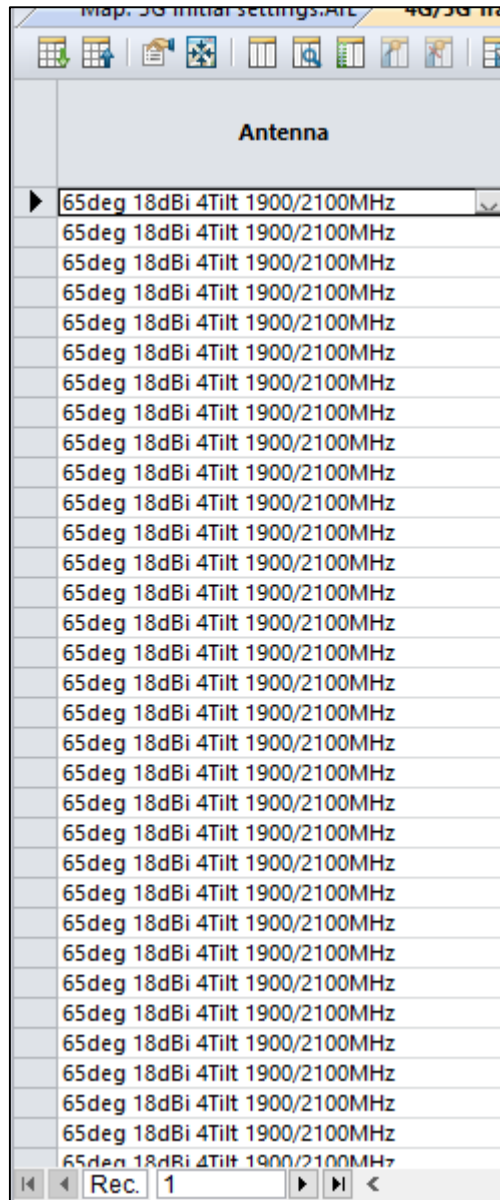


**Figure 3. 87:** Simulation results after decreasing transmitter height to 20m

It is noticed that there is an optimization of simulation results due to the decrease of transmitters height. The percentage of connected users has increased from 24.2% to 27.3%, and this means there is an optimization of 3.1% of the total performance.

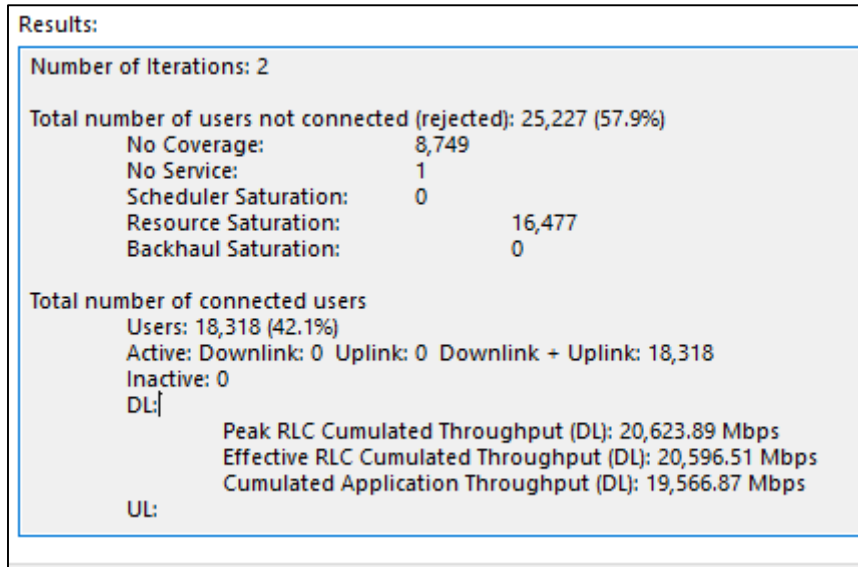
### 3.6.1.2 Changing type of Antenna

After many tests we found out that it is necessary to change the type of the antenna used in the transmitter properties to be (65deg 18dBi 4Tilt 1900/2100MHz). This change led into a significant improvement of the results obtained after the change. The following figure shows the new settings of antenna type in the transmitters table;



**Figure 3. 88:** setting the antenna type of the transmitter

The following figure shows the result that has been obtained due to the previously mentioned modification that has led to an optimization of performance;



**Figure 3. 89:** Simulation results after changing the type of antenna

It is noticed that there is an optimization of simulation results due to the decrease of transmitters height. The percentage of connected users has increased from 27.3% to 42.1%, and this means there is an optimization of 14.8% of the total performance.

### 3.6.1.3 Changing the Frequency Band

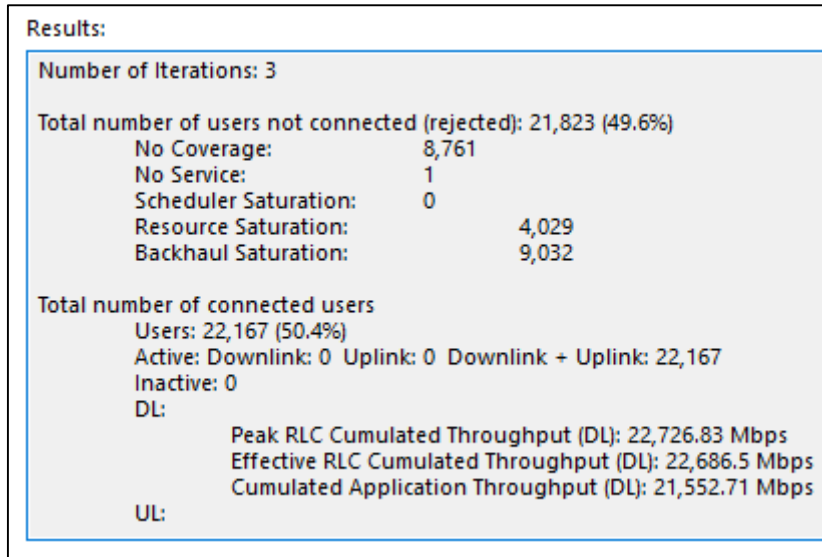
After many tests, we found out that it is necessary to frequency band to (n260) within each cell. This band has a reference frequency of 37GHz. The following figure shows the bands list and the new settings of frequency band in the cells table;



Name	Reference Frequency (MHz)
n1 / E-UTRA 1	2,110
n2 / E-UTRA 2	1,930
n20 / E-UTRA 20	791
n257	26,500
n258	24,250
n260	37,000
n28 / E-UTRA 28	758
n3 / E-UTRA 3	1,805
n41 / E-UTRA 41	2,496
n5 / E-UTRA 5	869
n66 / E-UTRA 66	2,110
n7 / E-UTRA 7	2,620
n78	3,300
n8 / E-UTRA 8	925
*	

**Figure 3. 90:** Frequency bands window



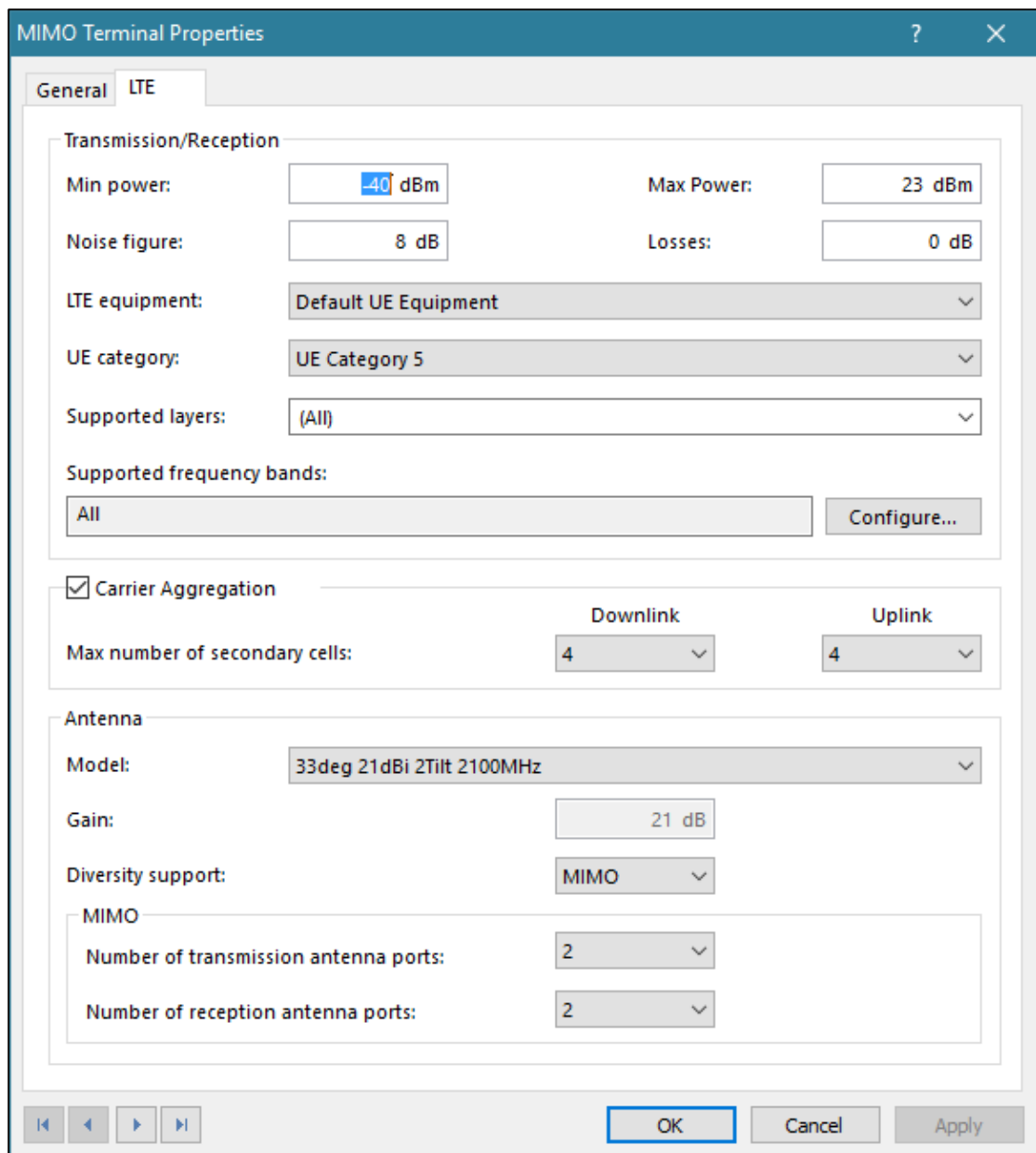


**Figure 3. 92:** Simulation results after modifying settings of frequency band

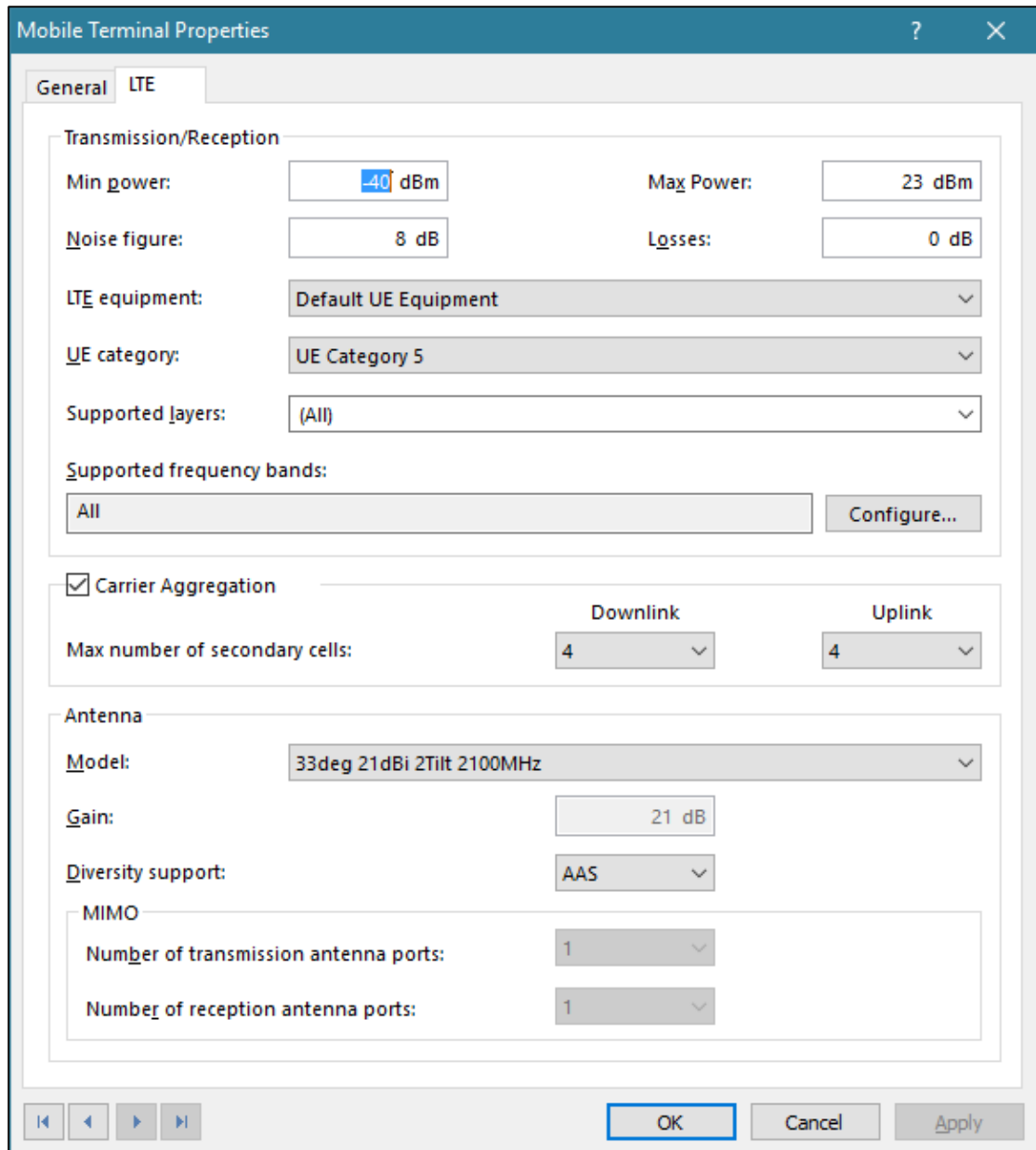
It is noticed that there is an optimization of simulation results due to modifying settings of frequency band column within cells table. The percentage of connected users has increased from 42.1% to 50.4%, and this means there is an optimization of 8.3% of the total performance.

#### 3.6.1.4 Modifying User Terminals

After many tests, it was found out that it is necessary to make some modifications on the UE terminals. Those modifications include allowing carrier aggregation, and adopting a different type of antenna with a better gain of 21dB, and using MIMO technique on one type of UE terminals which is name MIMO, and the other terminal that is named Mobile Terminal was left without enabling the MMIO feature on it. The following figures show the new settings of the tow terminals;

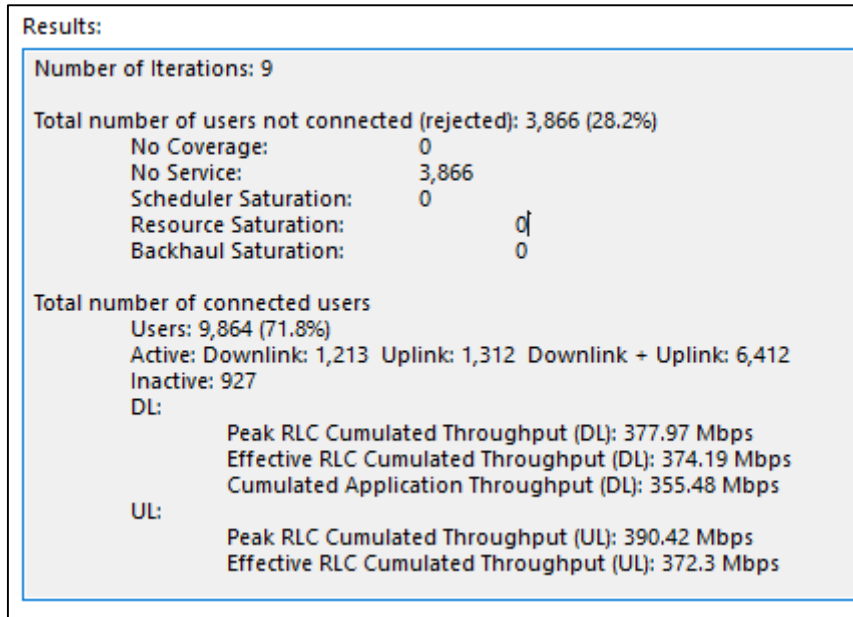


**Figure 3. 93:** Modified settings of MIMO terminal in the 5G NR design



**Figure 3. 94:** Modified settings of Mobile terminal in the 5G NR design

The following figure shows the result that has been obtained due to the previously mentioned modification that has led to an optimization of performance;



**Figure 3. 95:** Simulation results after the modifications of UE terminals

It is noticed that there is an optimization of simulation results due to the increase of max power of cells. The percentage of connected users has increased from 66% to 71.8%, and this means there is an optimization of 5.8% of the total performance.

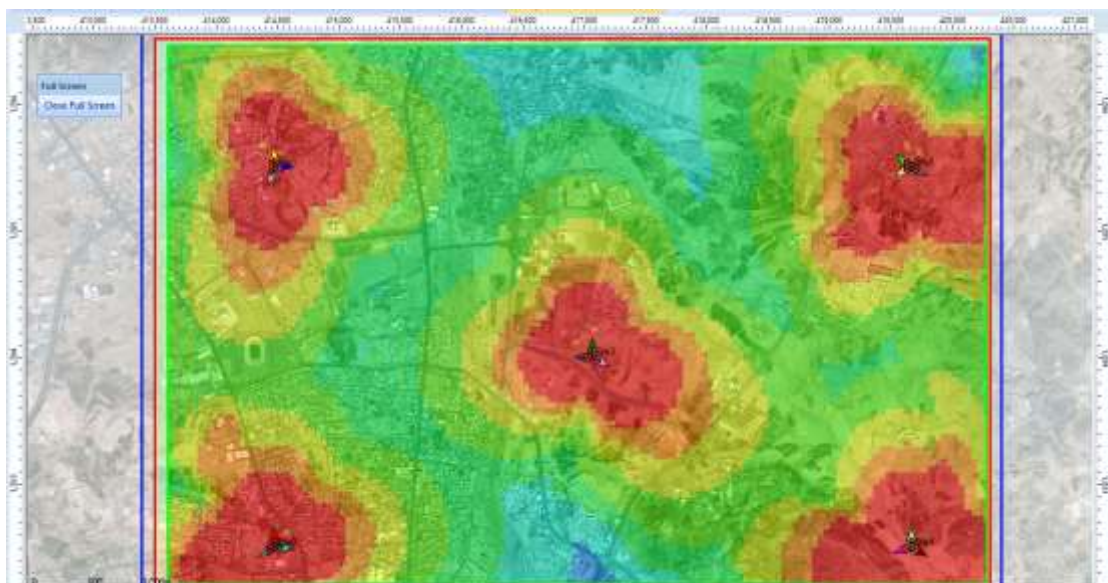
### 3.6.1.6 Modifying Azimuth Angle and Mechanical Down-tilt of Transmitters

After many tests, it was found out that it is necessary to make some modifications on the Azimuth Angle and Mechanical Down-tilt of Transmitters. The changes of azimuth angle was based on what was observed on the map in term of signal level prediction results. Some transmitters were shifted to new angles to cover areas with low signal levels, and for the same purpose the mechanical down-tilt has been change from 0 to -5° This allowed more users to get better signal level and this means they became able to use higher borers with a better modulation scheme and coding rate, and this made the able to use different services effectively. The following figure shows the new settings of azimuth angle and mechanical down-tilt;

Azimuth (°)	Mechanical Downtilt (°)	Additional Electrical Downtilt (°)
0	-5	0
88	-5	0
240	-5	0
0	-5	0
90	-5	0
197	-5	0
0	-5	0
120	-5	0
272	-5	0
0	-5	0
120	-5	0
253	-5	0
311	-5	0
120	-5	0
240	-5	0

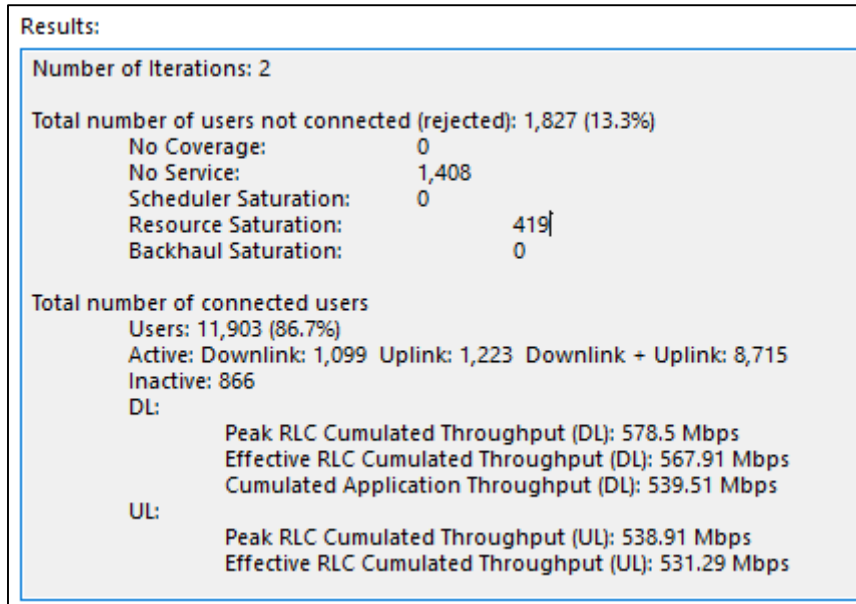
**Figure 3. 96:** Modified settings of Azimuth Angle and Mechanical Down-tilt of Transmitters

The following figure shows the studied area with the signal level prediction results after the modification of azimuth angle and mechanical down-tilt of transmitters;



**Figure 3. 97:** the studied area with the signal level prediction results after the modification of azimuth angle and mechanical down-tilt of transmitters

The following figure shows the result that has been obtained due to the previously mentioned modification that has led to an optimization of performance;



**Figure 3. 98:** Simulation results after the modifications of azimuth angle and mechanical down-tilt of transmitters in 5G NR design

It is noticed that there is an optimization of simulation results due to the increase of max power of cells. The percentage of connected users has increased from 71.8% to 86.7%, and this means there is an optimization of 14.9% of the total performance.

### 3.6.1.7 Modifying Frequency Band and the number of co-scheduled MU-MIMO

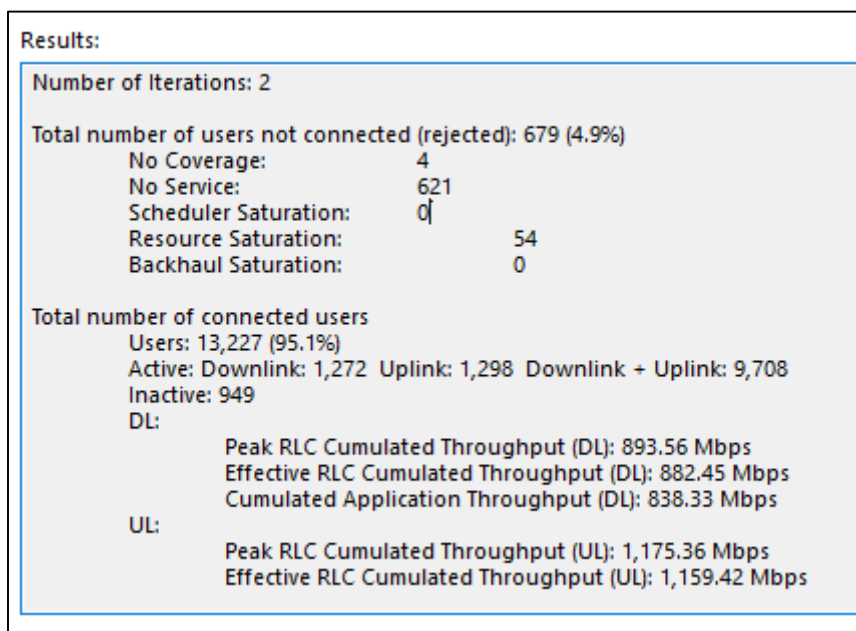
After many tests, it was found out that it is necessary to make some modifications on the Frequency Band and the number of co-scheduled MU-MIMO. The change of frequency band was based on what was observed on the frequency bands listed in a separated table within the software. The number of co-scheduled MU-MIMO refers to the average number of MU-MIMO users that share the same resources on the downlink and uplink. In downlink throughput coverage predictions, cell capacity is multiplied by this gain on pixels where MU-MIMO is used. The following figure shows the



new settings of Frequency Band and the number of co-scheduled MU-MIMO;

**Figure 3. 99:** Modified settings of Frequency Band and the number of co-scheduled MU-MIMO

The following figure shows the result that has been obtained due to the previously mentioned modification that has led to an optimization of performance;



**Figure 3. 100:** Simulation results after the modifications Frequency Band and the number of co-scheduled MU-MIMO in 5G NR design

It is noticed that there is an optimization of simulation results due to the increase of max power of cells. The percentage of connected users has increased from 86.7% to 95.1%, and this means there is an optimization of 8.4% of the total performance.

This result is somewhat acceptable in a practical environment, and it was found out that it is too difficult to go further and get better results no matter

how many other changes are done, so we stop at this level of optimization that has been accomplished.

**CHAPTER FOUR**

**RESULTS ANALYZING  
AND DISCUSSION**

# CHAPTER 4

## RESULTS ANALYZING AND DISCUSSION

### 4.1 Introduction

This chapter presents the final results that have achieved after the optimization process that has been done and explained in the previous chapter. For the purpose of comparison, each result presented in this chapter is preceded by the result of the same factor but before the optimization process that has been conducted earlier.

### 4.2 Results and Discussions

This part discusses the results that have been gotten before and after optimizing the performance through several steps.

#### 4.2.1 LTE

This part deals with results related to LTE technology.

##### 4.5.1.1 Coverage by Transmitter (DL)

The following figures show the prediction result of Coverage by Transmitter (DL) in LTE technology. The first figure shows the results before the

optimization process that has been done and explained in the previous chapter, and the second figure shows the results after the optimization;



**Figure 4. 1:** prediction result of Coverage by Transmitter (DL) in LTE technology (Before optimization)



**Figure 4. 2:** prediction result of Coverage by Transmitter (DL) in LTE technology (After optimization)

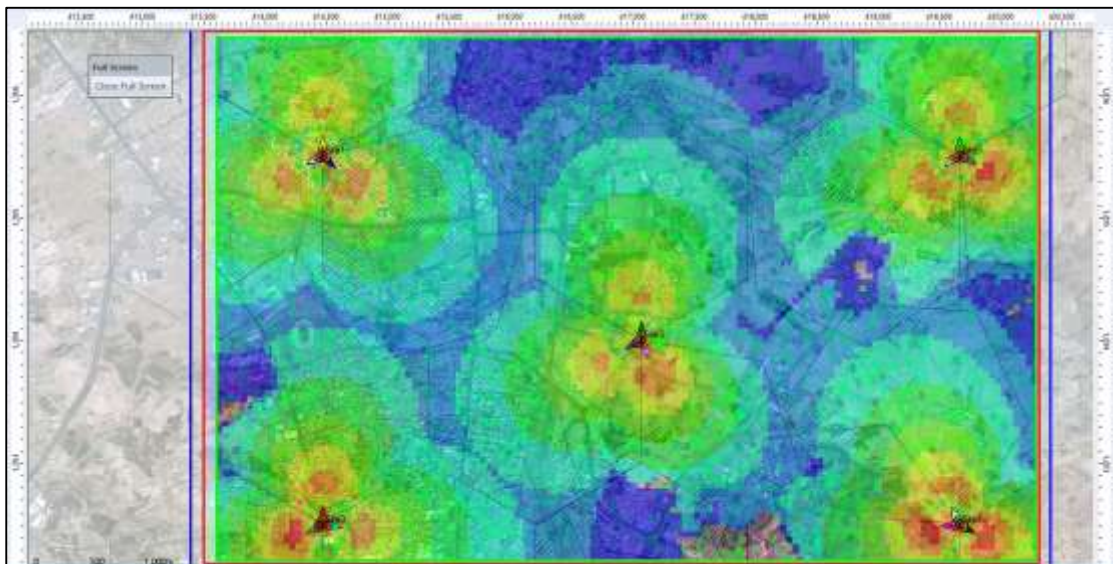
It is noticed from the previous figures that there is an enhancement in term of coverage by transmitter. Each transmitter became able to cover a larger area. The whole studied area became well covered by transmitters.

#### 4.5.1.2 Coverage by Signal Level (DL)

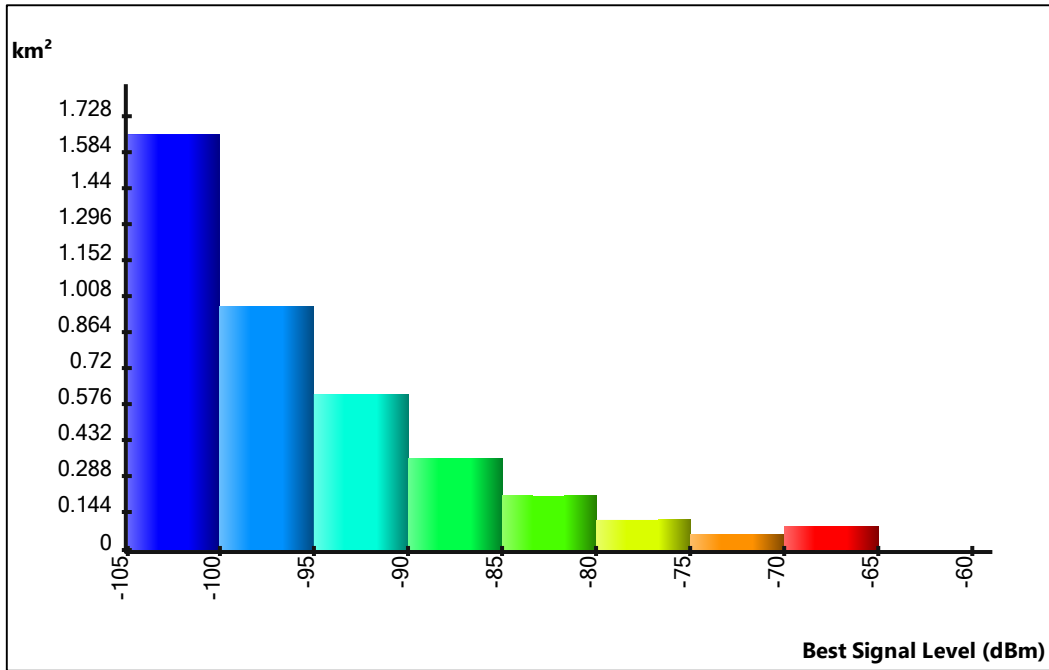
The following figures show the map and histogram prediction results of Coverage by Signal Level (DL) in LTE technology. The first figure shows the results before the optimization process that has been done and explained in the previous chapter, and the second figure shows the results after the optimization;



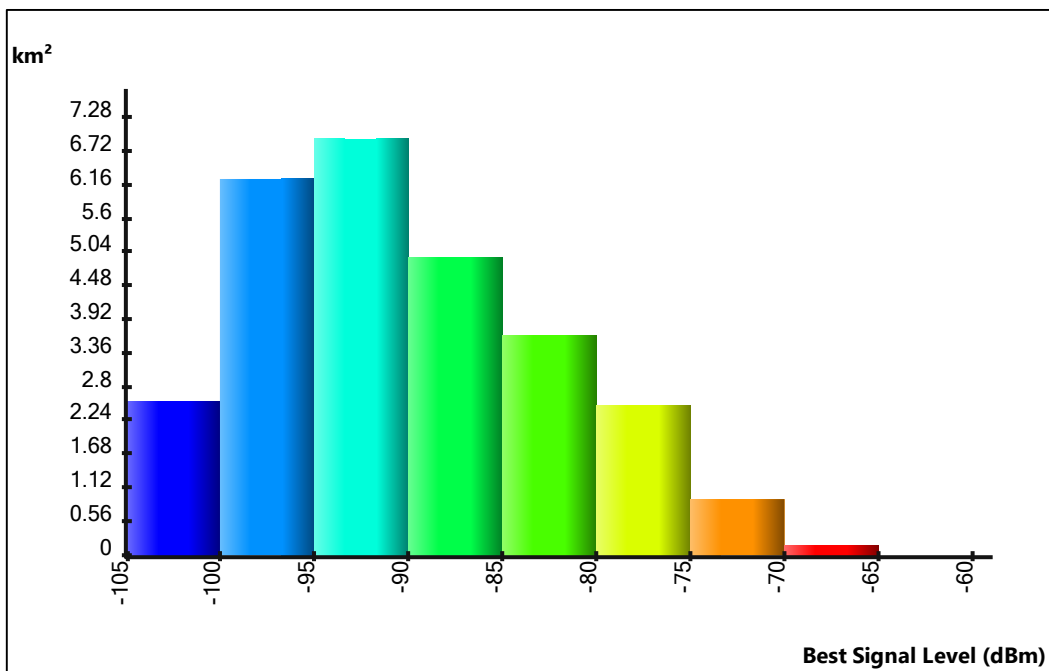
**Figure 4. 3:** prediction result of Coverage by Signal Level (DL) in LTE technology (Before optimization)



**Figure 4. 4:** prediction result of Coverage by Signal Level (DL) in LTE technology (After optimization)



**Figure 4. 5:** prediction histogram of Coverage by Signal Level (DL) in LTE technology (Before optimization)



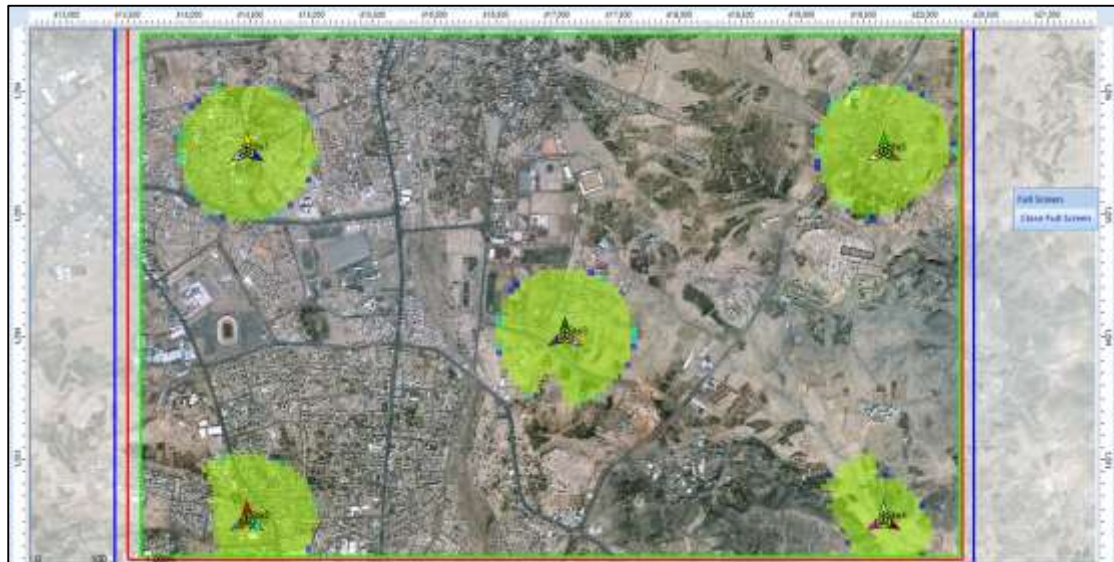
**Figure 4. 6:** prediction histogram of Coverage by Signal Level (DL) in LTE technology (After optimization)

It is noticed from the previous figures that there is an enhancement in term of Signal Level (DL). Good signal levels such as; -85,-90 and -95 became

available on a wider range. Before optimization, they were available on a short range of less than  $1\text{km}^2$ , but after optimization, they became available on a wide range of more than  $4\text{km}^2$ .

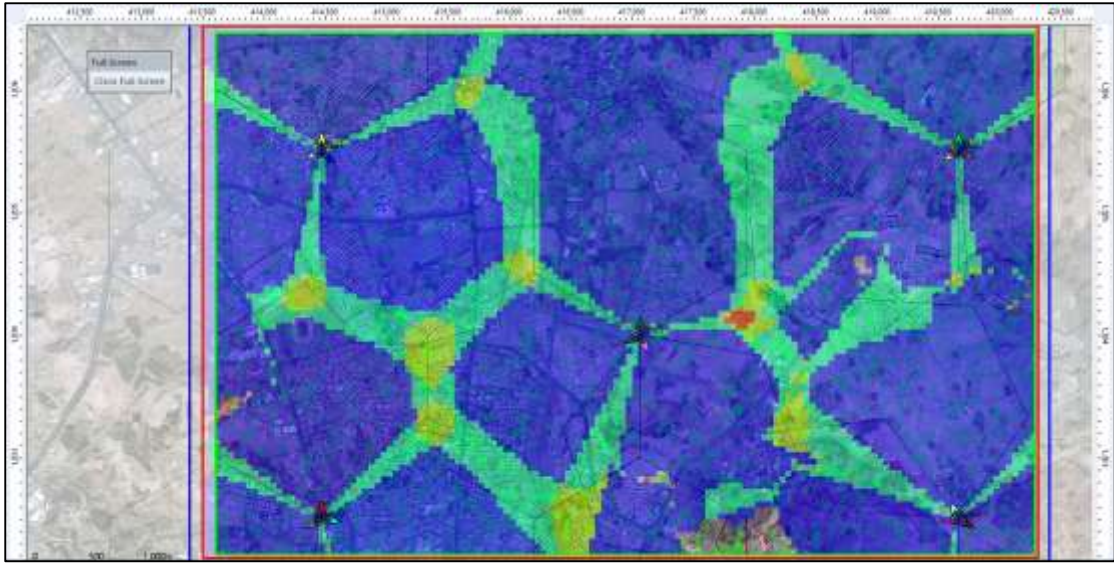
#### 4.5.1.4 Overlapping Zones (DL)

The following figures show the map and histogram prediction results of Overlapping Zones (DL) in LTE technology. The first figure shows the results before the optimization process that has been done and explained in the previous chapter, and the second figure shows the results after the optimization. The first figure shows the results before the optimization process that has been done and explained in the previous chapter, and the second figure shows the results after the optimization;

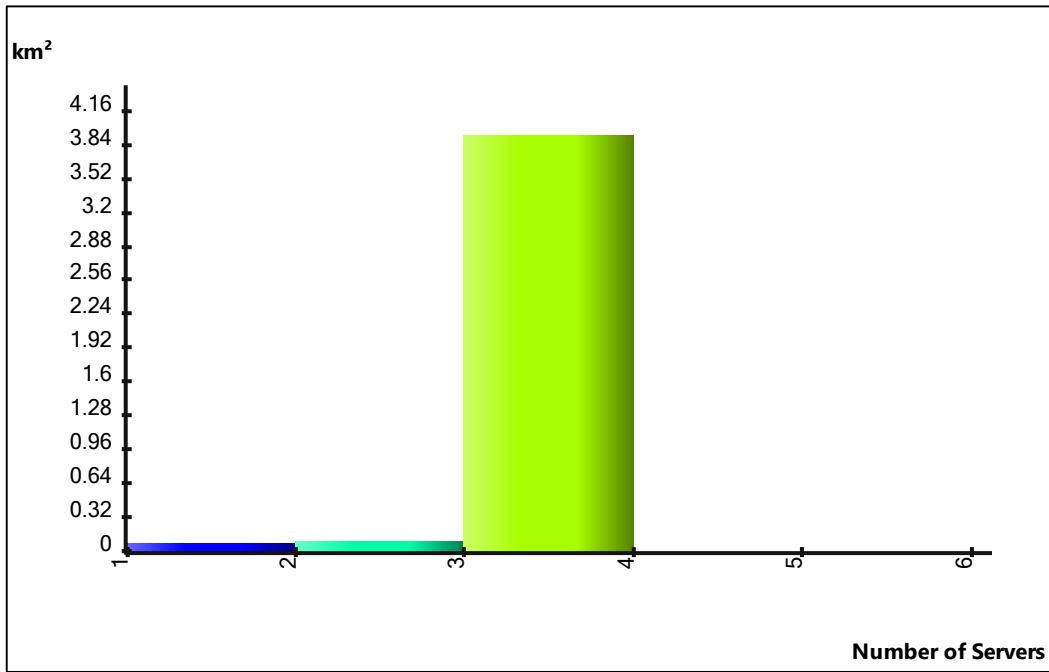


**Figure 4. 7:** prediction histogram of Coverage by Signal Level (DL) in LTE technology (Before optimization)

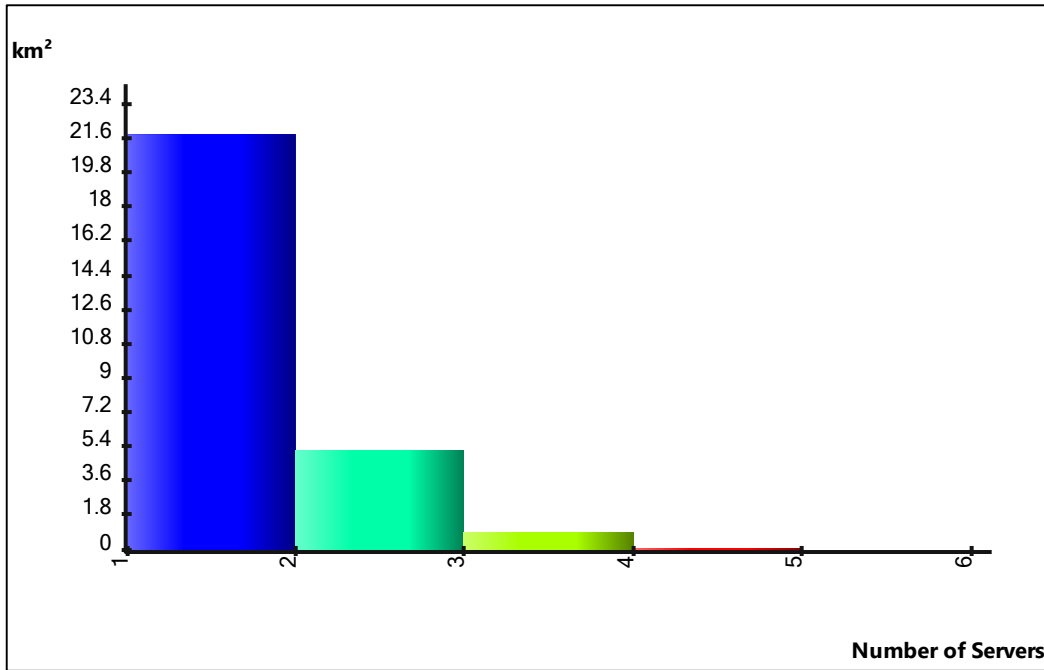




**Figure 4. 8:** prediction result of Overlapping Zones (DL) in LTE technology (After optimization)



**Figure 4. 9:** prediction histogram of Overlapping Zones (DL) in LTE technology (Before optimization)

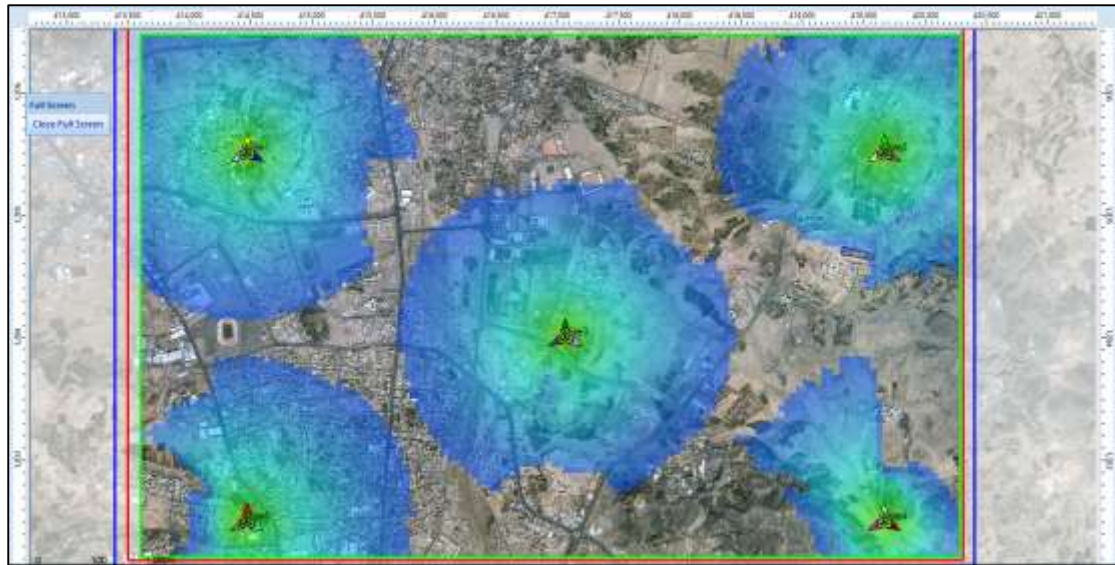


**Figure 4. 10:** prediction histogram of Overlapping Zones (DL) in LTE technology (After optimization)

It is noticed from the previous figures that there is an enhancement in term of Overlapping Zones (DL). The dark blue color of the histogram shows that most parts of the studied area are covered by only one transmitter, unlike the previous histograms, which shows a yellow bar of the histogram, and this mean that the three transmitters that are mounted on the base station overlap on the small area around each base station while other parts are not covered.

#### 4.5.1.4 Effective Signal Analysis (DL)

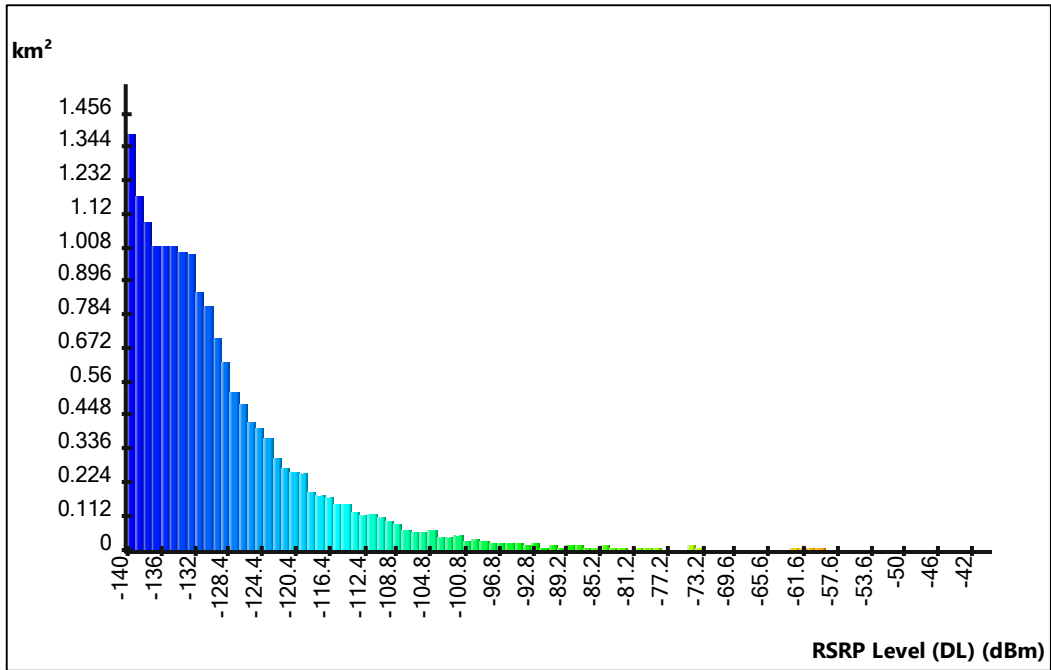
The following figures show the map and histogram prediction results of Effective Signal Analysis (DL) in LTE technology. The first figure shows the results before the optimization process that has been done and explained in the previous chapter, and the second figure shows the results after the optimization;



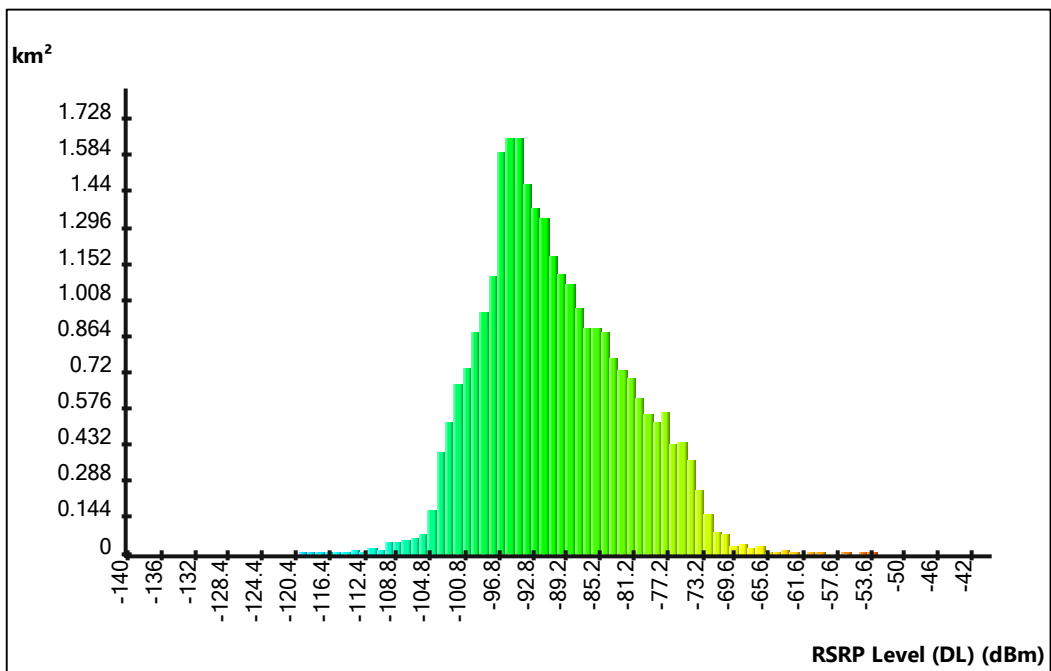
**Figure 4. 11:** prediction result of Effective Signal Analysis (DL) in LTE technology (Before optimization)



**Figure 4. 12:** prediction result of Effective Signal Analysis (DL) in LTE technology (After optimization)



**Figure 4. 13:** prediction histogram of Effective Signal Analysis (DL) in LTE technology (Before optimization)



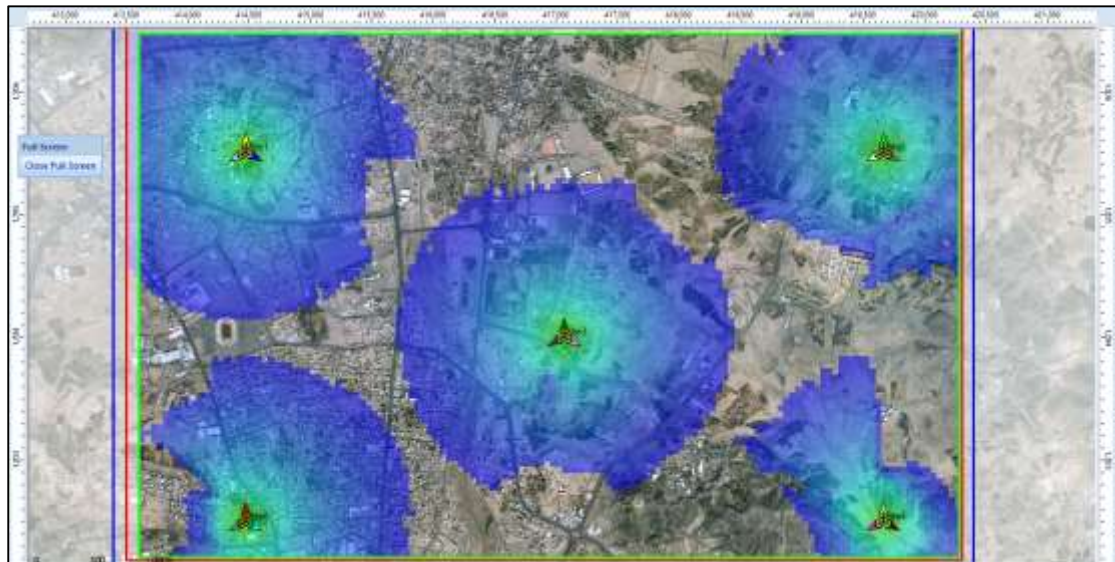
**Figure 4. 14:** prediction histogram of Effective Signal Analysis (DL) in LTE technology (After optimization)

It is noticed from the previous figures that there is an enhancement in term of Effective Signal Analysis (DL). The levels of RSRP (Reference Signal

Received Power) are good. Levels around -85 and -95 dBm are strong and cover large areas of more than 1.4km<sup>2</sup>. While such values were not available in more than 100m range before optimization.

#### 4.5.1.5 Effective Signal Analysis (UL)

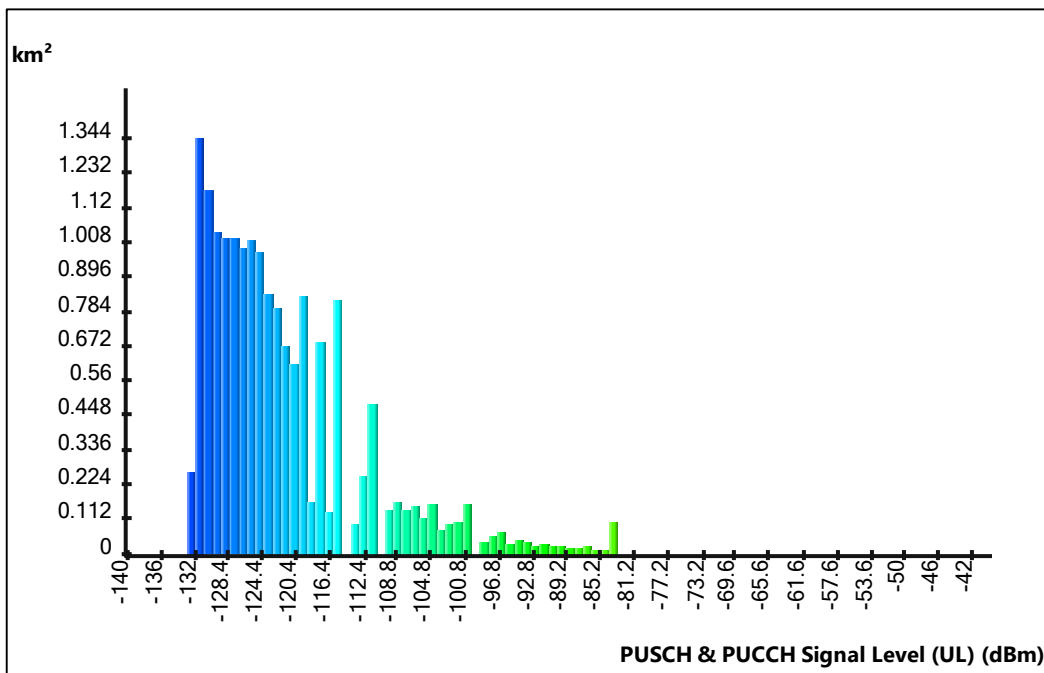
The following figures show the map and histogram prediction results of Effective Signal Analysis (UL) in LTE technology. The first figure shows the results before the optimization process that has been done and explained in the previous chapter, and the second figure shows the results after the optimization;



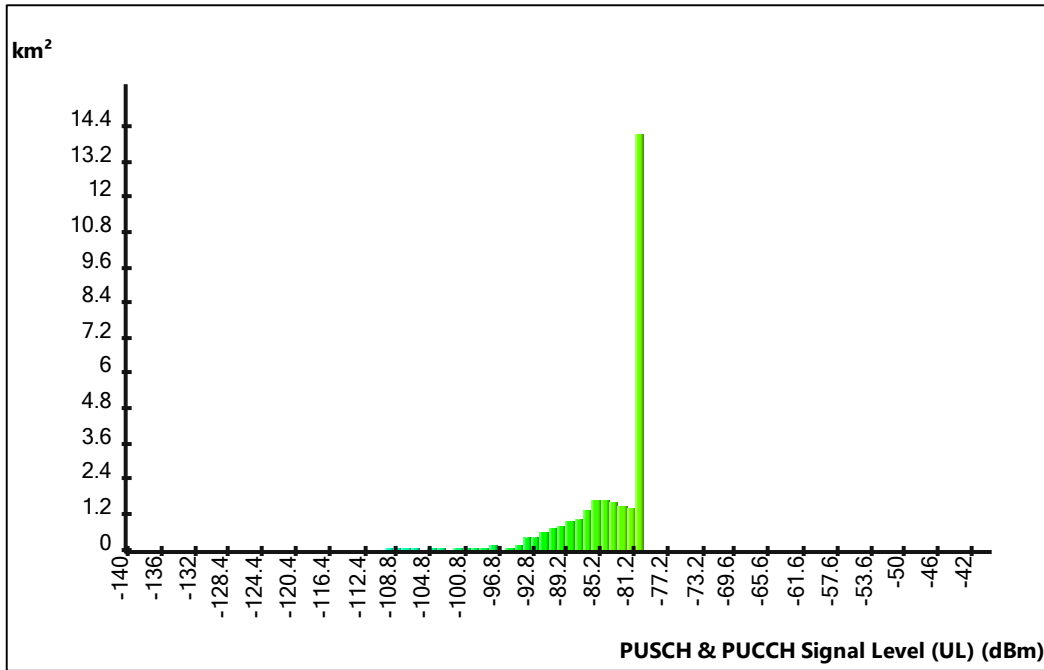
**Figure 4. 15:** prediction result of Effective Signal Analysis (UL) in LTE technology (Before optimization)



**Figure 4. 16:** prediction result of Effective Signal Analysis (UL) in LTE technology (After optimization)



**Figure 4. 17:** prediction histogram of Effective Signal Analysis (UL) in LTE technology (Before optimization)



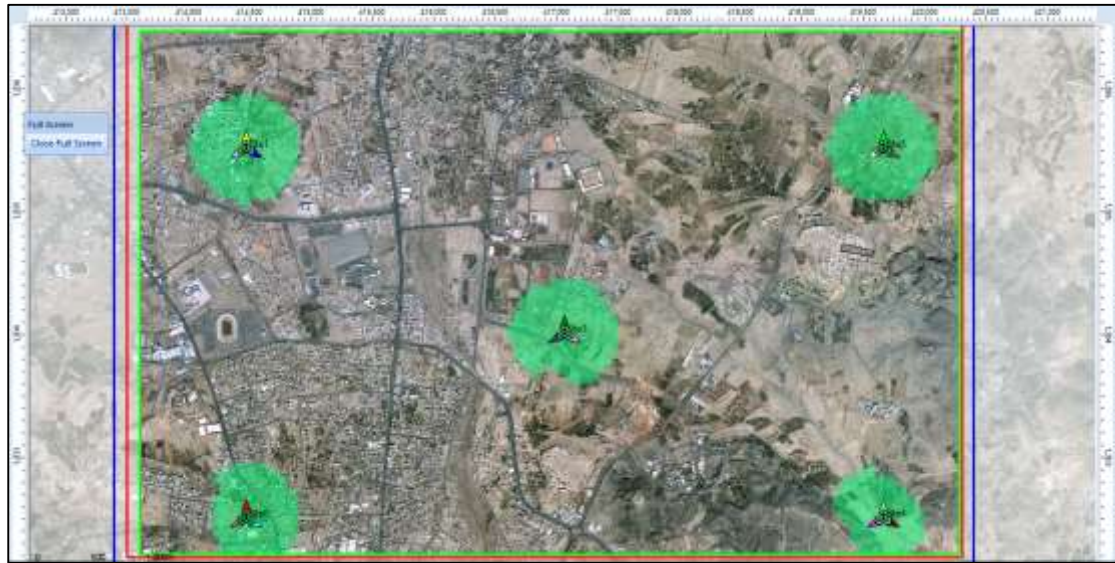
**Figure 4. 18:** prediction histogram of Effective Signal Analysis (UL) in LTE technology (After optimization)

It is noticed from the previous figures that there is an enhancement in term of of Effective Signal Analysis (UL). Signals such as; PUCCH (Physical Uplink Control Channel) and PUSCH (Physical Uplink Shared Channel) have good levels of about -80dBm, and this level is available in a wide range of more than 14km<sup>2</sup>, while such value was limited only to less than 100m before optimization. These signals are used for uplink control information, mainly scheduling decisions, required for reception of PDSCH and for scheduling grants enabling transmission on the PUSCH.

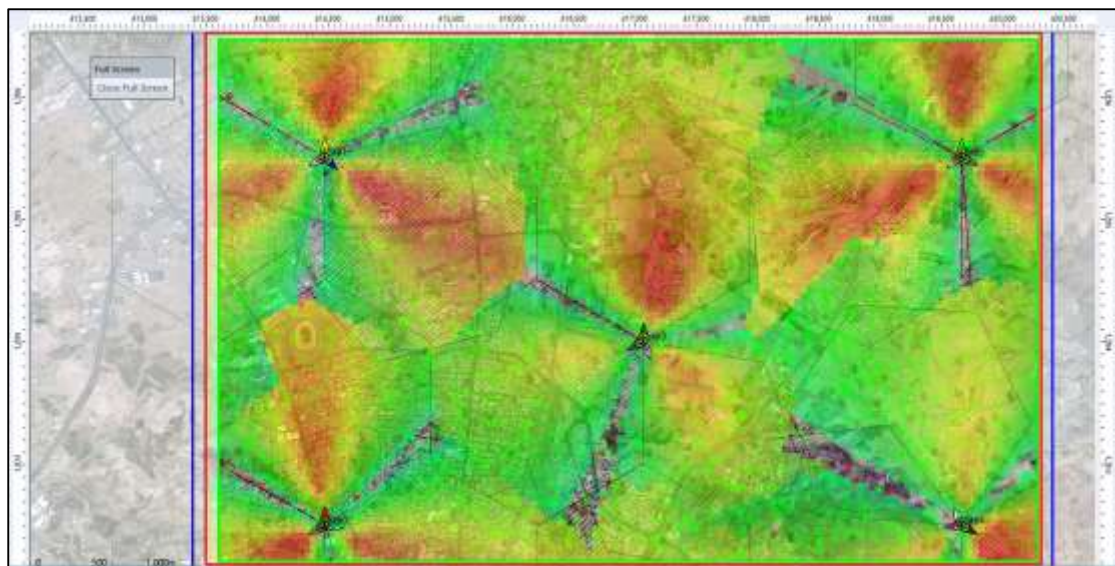
#### 4.5.1.7 Coverage by C/(I+N) Level (DL)

The following figures show the map and histogram prediction results of Coverage by C/(I+N) Level (DL) in LTE technology. The first figure shows the results before the optimization process that has been done and explained

in the previous chapter, and the second figure shows the results after the optimization;

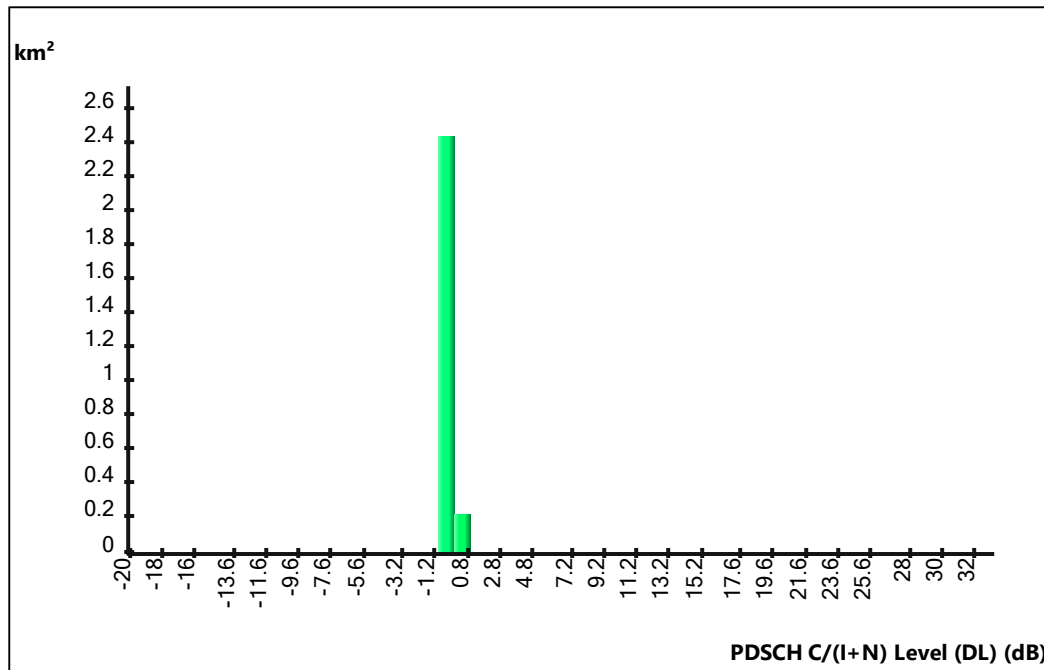


**Figure 4. 19:** prediction result of Coverage by C/(I+N) Level (DL) in LTE technology (Before optimization)

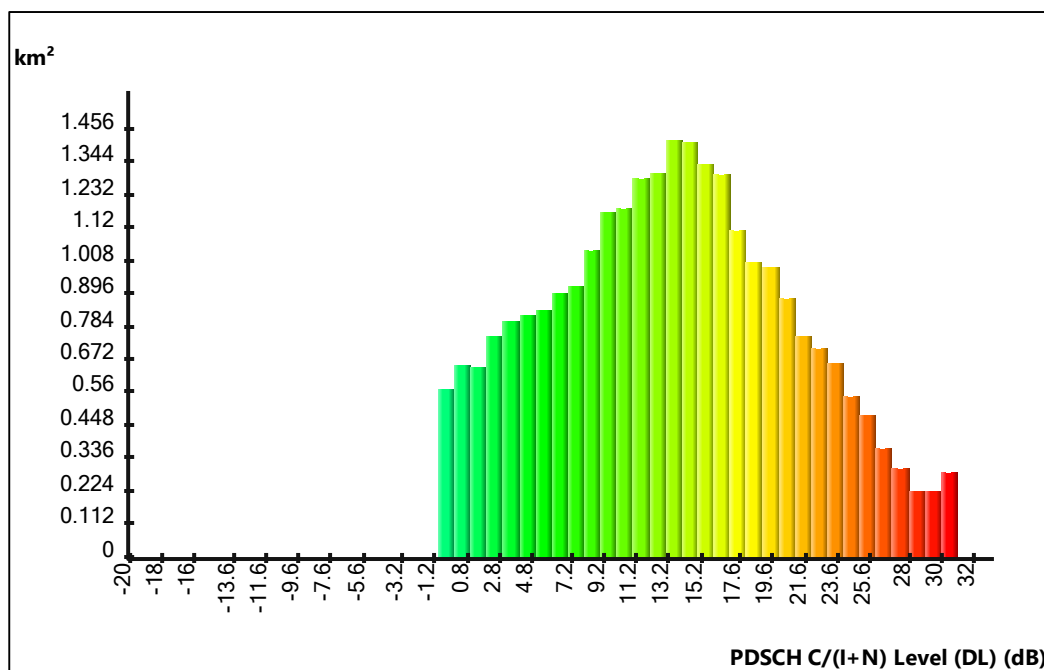


**Figure 4. 20:** prediction result of Coverage by C/(I+N) Level (DL) in LTE technology (After optimization)





**Figure 4. 21:** prediction histogram of Coverage by C/(I+N) Level (DL) in LTE technology (Before optimization)



**Figure 4. 22:** prediction histogram of Coverage by C/(I+N) Level (DL) in LTE technology (After optimization)

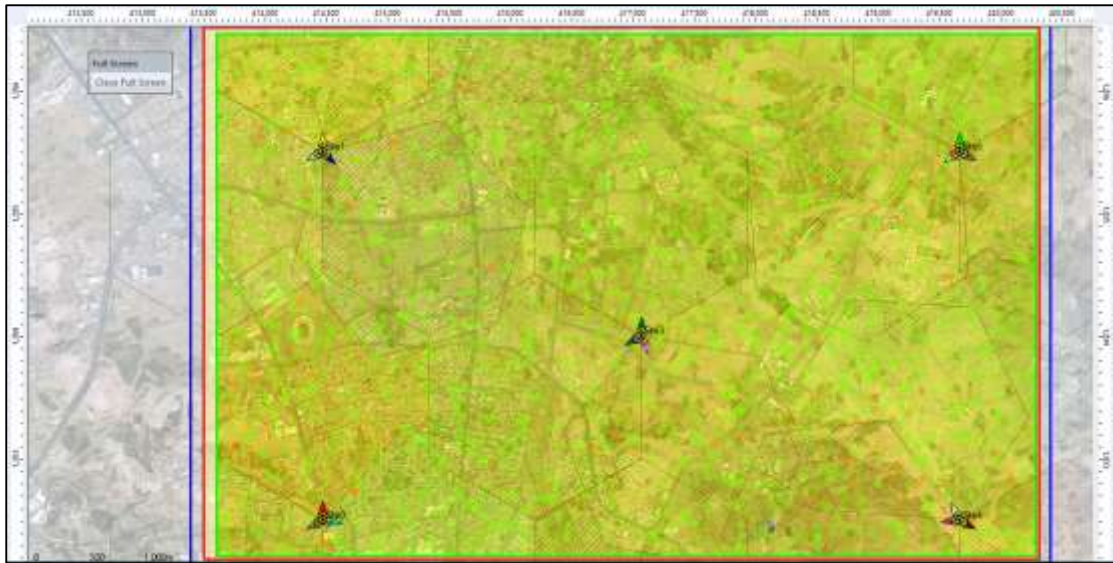
It is noticed from the previous figures that there is an enhancement in term of C/(I+N) Level (DL). Good levels such as; 15dB and 17dB are available on a wide range of more than 1.2km<sup>2</sup> after optimization. Such values were not available at all before optimization process.

#### 4.5.1.8 Coverage by C/(I+N) Level (UL)

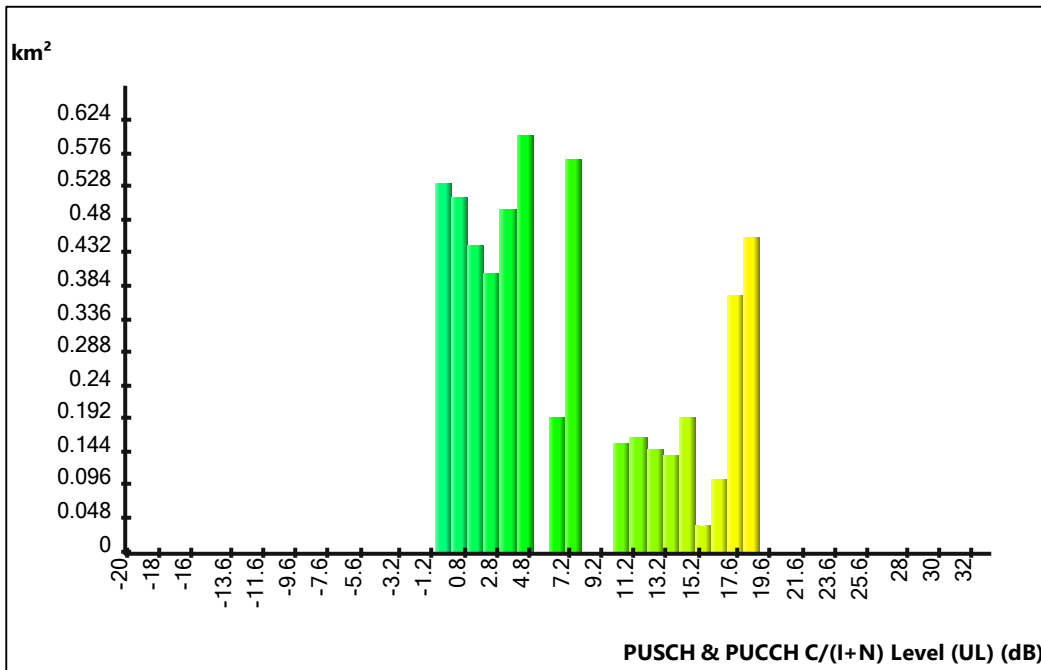
The following figures show the map and histogram prediction results of Coverage by C/(I+N) Level (UL) in LTE technology. The first figure shows the results before the optimization process that has been done and explained in the previous chapter, and the second figure shows the results after the optimization;



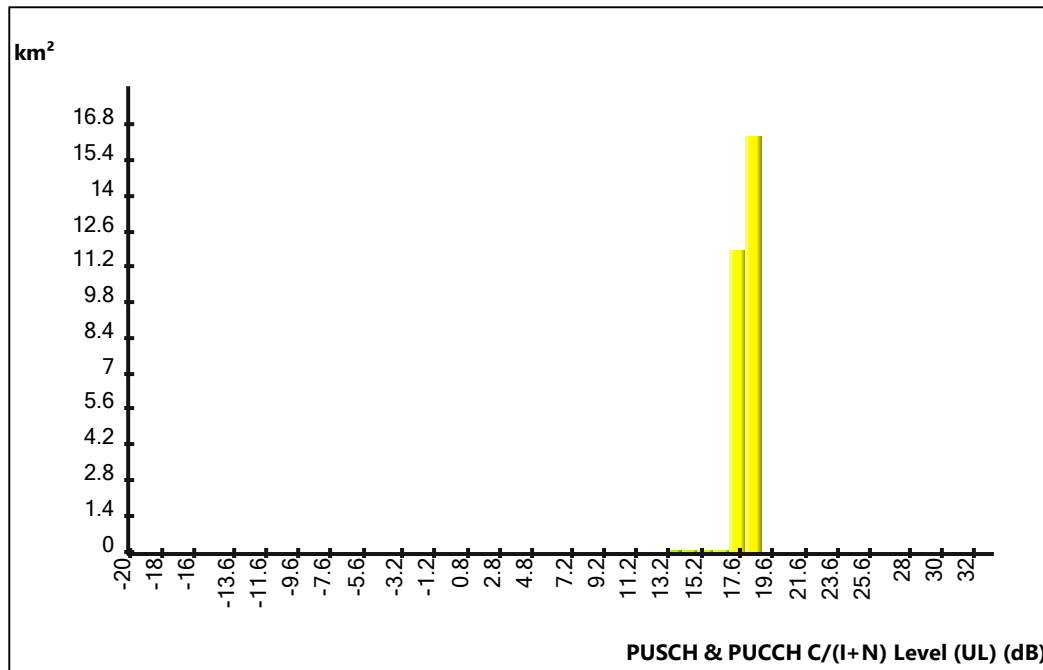
**Figure 4. 23:** prediction result of Coverage by C/(I+N) Level (UL) in LTE technology (Before optimization)



**Figure 4.24:** prediction result of Coverage by C/(I+N) Level (UL) in LTE technology (After optimization)



**Figure 4.25:** prediction histogram of Coverage by Coverage by C/(I+N) Level (UL) in LTE technology (Before optimization)

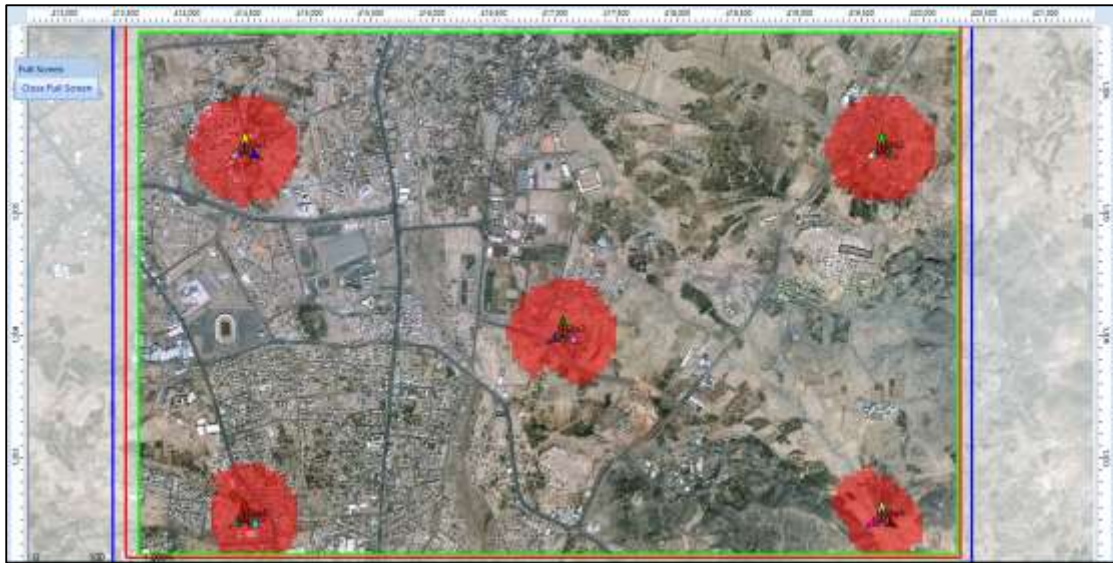


**Figure 4. 26:** prediction histogram of Coverage by Coverage by C/(I+N) Level (UL) in LTE technology (After optimization)

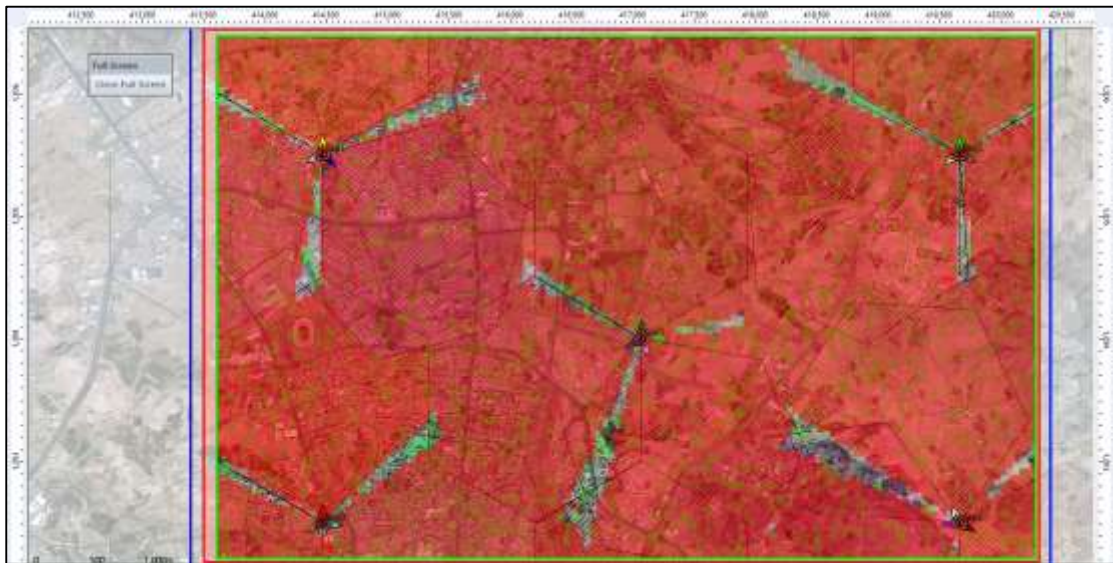
It is noticed from the previous figures that there is an enhancement in term of C/(I+N) Level (UL). Good levels such as; 17dB and 19dB are available on a wide range of more than 11km<sup>2</sup> after optimization. Such values were available within a short range of less than 0.5km<sup>2</sup> before optimization process.

#### 4.5.1.9 Effective Service Area Analysis (DL+UL)

The following figures show the prediction result of Effective Service Area Analysis (DL+UL) in LTE technology. The first figure shows the results before the optimization process that has been done and explained in the previous chapter, and the second figure shows the results after the optimization;



**Figure 4. 27:** prediction result of Effective Service Area Analysis (DL+UL) in LTE technology (Before optimization)



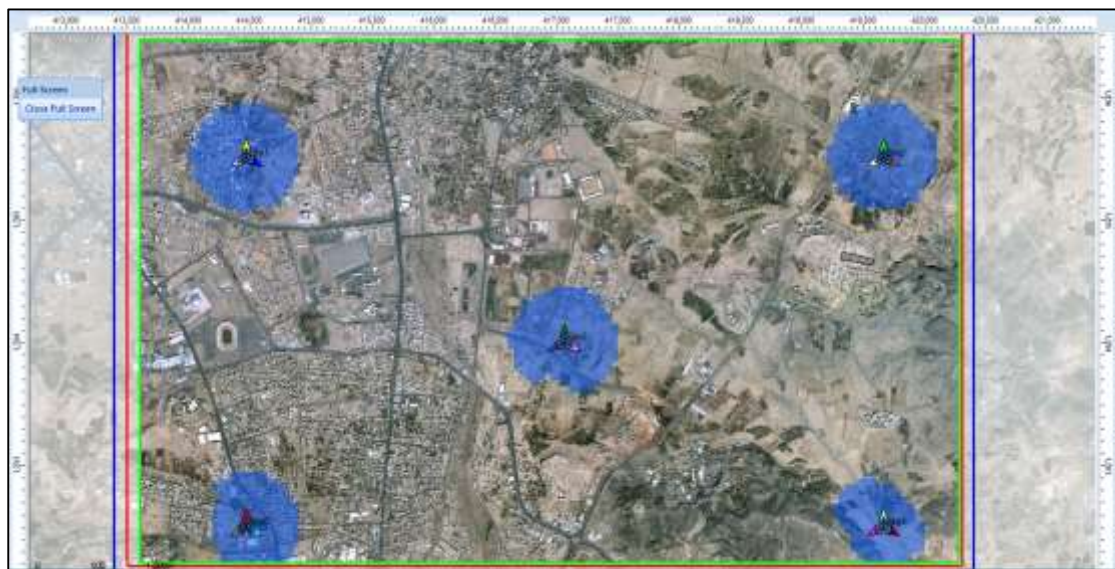
**Figure 4. 28:** prediction result of Effective Service Area Analysis (DL+UL) in LTE technology (After optimization)

It is noticed from the previous figures that there is an enhancement in term of Effective Service Area Analysis (DL+UL). The effective service area is the intersection zone between the uplink and downlink service areas. In other words, the effective service area prediction calculates where a service actually is available in both downlink and uplink. It is obvious that a wider

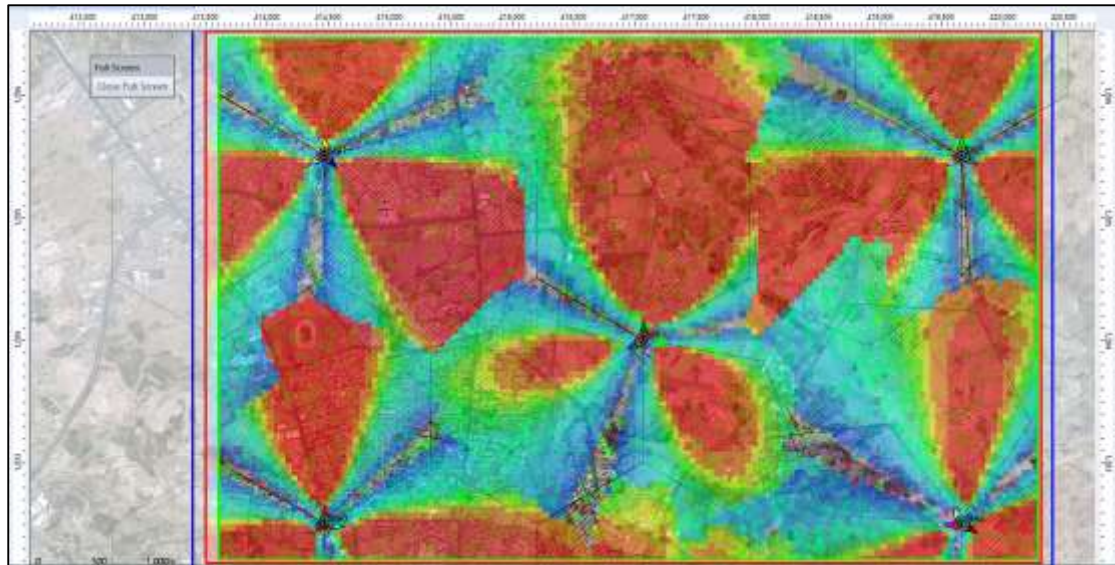
area became covered after the optimization process. Such coverage was not available at all before optimization process.

#### 4.5.1.10 Coverage by Throughput (DL)

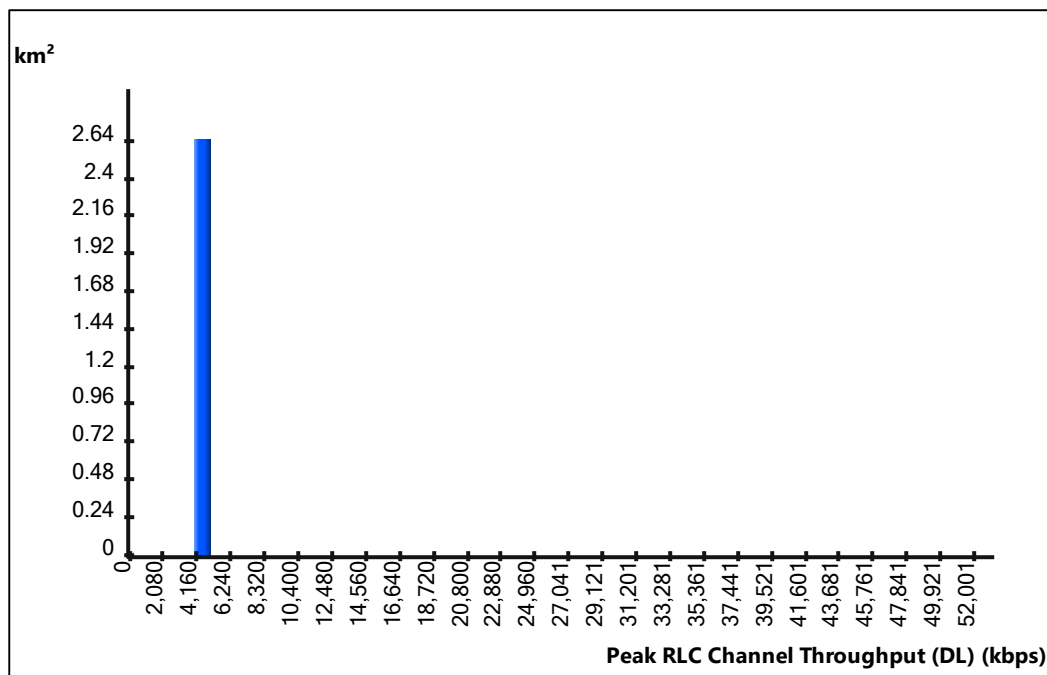
The following figures show the map and histogram prediction results of Coverage by Throughput (DL) in LTE technology. The first figure shows the results before the optimization process that has been done and explained in the previous chapter, and the second figure shows the results after the optimization;



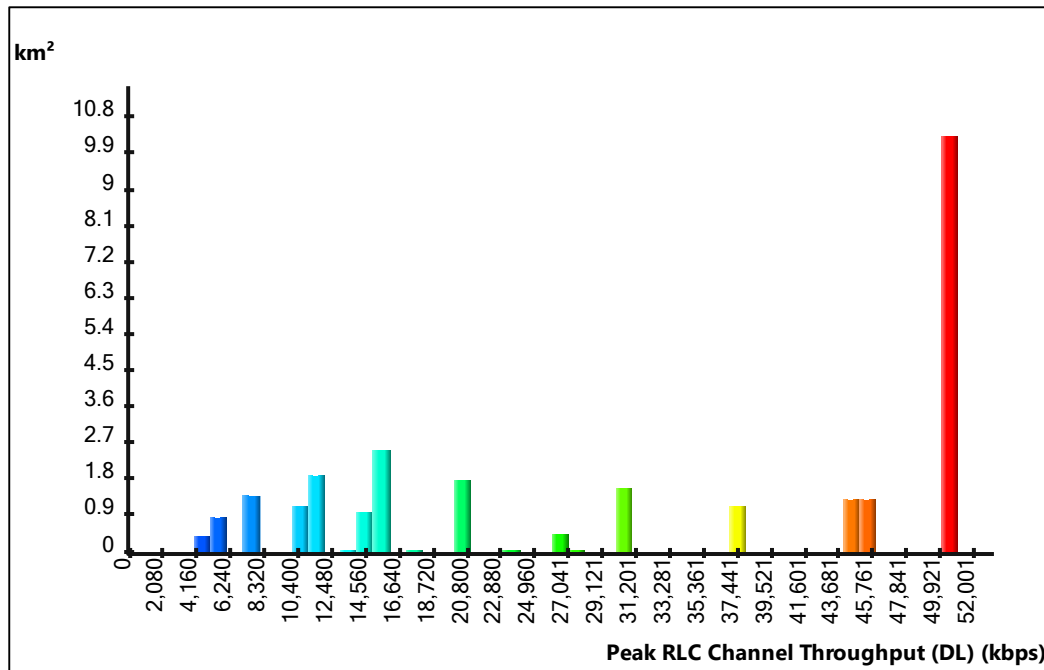
**Figure 4. 29:** prediction result of Coverage by Coverage by Throughput (DL) in LTE technology (Before optimization)



**Figure 4.30:** prediction result of Coverage by Coverage by Throughput (DL) in LTE technology (After optimization)



**Figure 4.31:** prediction histogram of Coverage by Throughput (DL) in LTE technology (Before optimization)



**Figure 4. 32:** prediction histogram of Coverage by Throughput (DL) in LTE technology (After optimization)

It is noticed from the previous figures that there is an enhancement in term of Coverage by Throughput (DL). Good levels such as; 45Mb and 50Mb are available on a wide range of more than 1km2 after optimization. Such values were not available at all before optimization process.

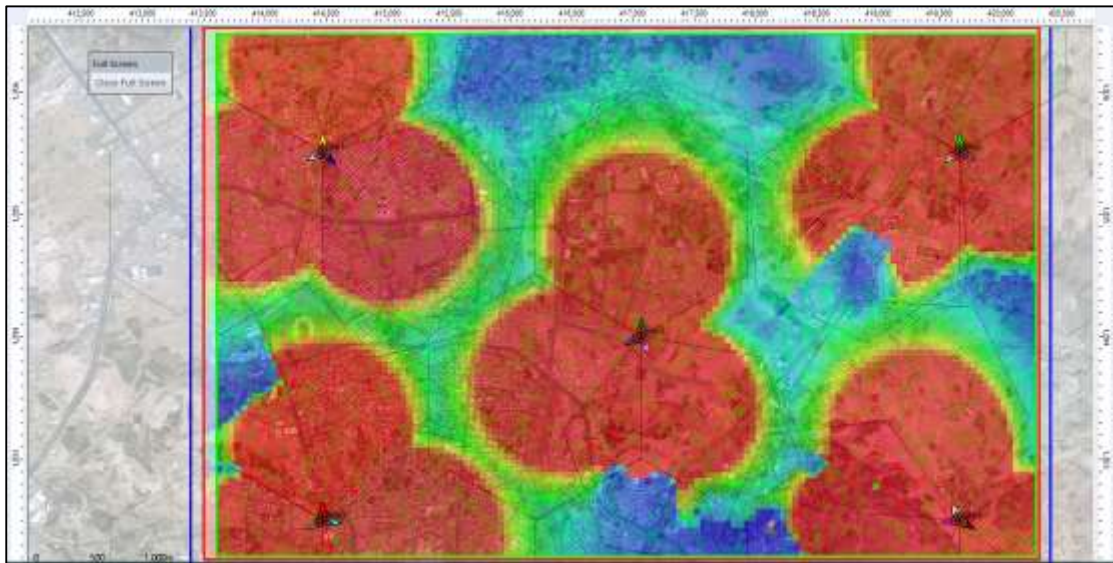
#### 4.5.1.11 Coverage by Throughput (UL)

The following figures show the map and histogram prediction results of Coverage by Throughput (UL) in LTE technology. The first figure shows the results before the optimization process that has been done and explained in the previous chapter, and the second figure shows the results after the optimization;

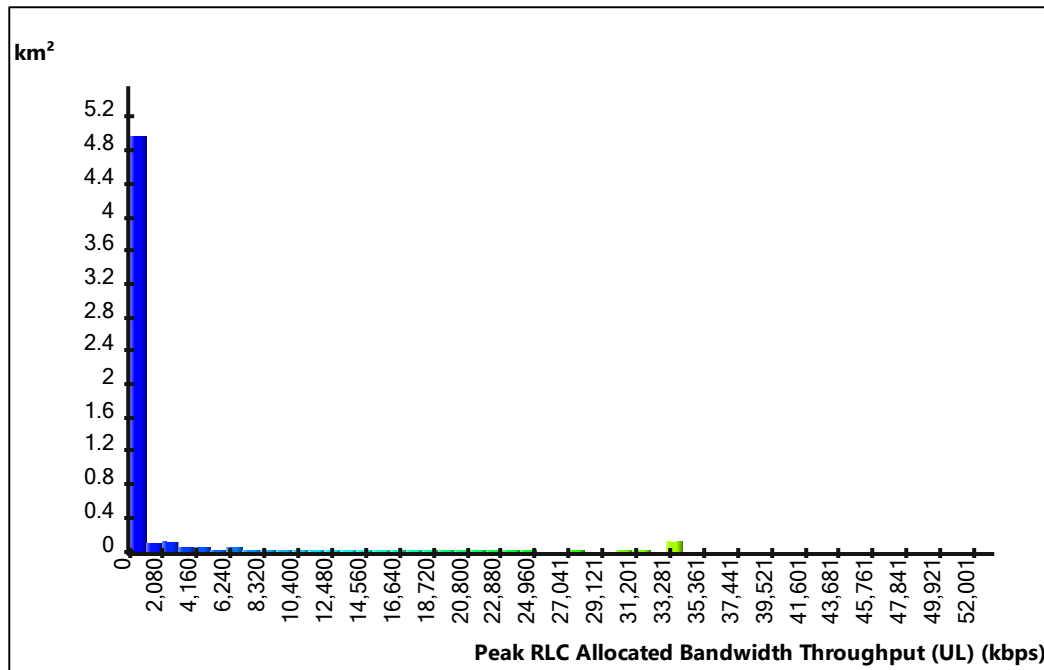




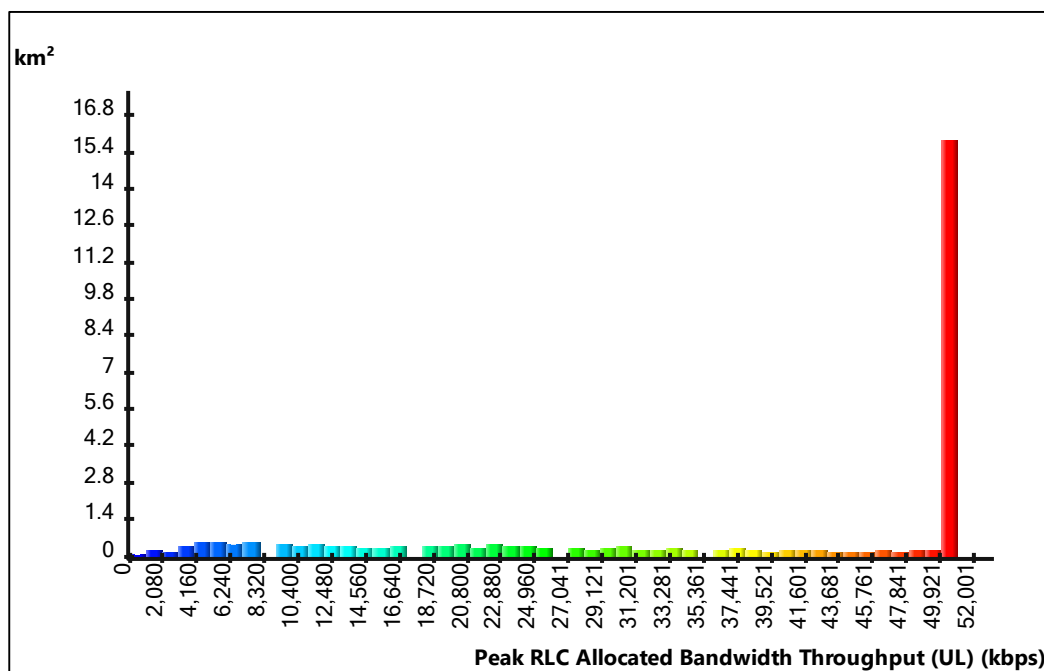
**Figure 4.33:** prediction result of Coverage by Throughput (UL) in LTE technology (Before optimization)



**Figure 4.34:** prediction result of Coverage by Throughput (UL) in LTE technology (After optimization)



**Figure 4. 35:** prediction histogram of Coverage by Throughput (UL) in LTE technology (Before optimization)



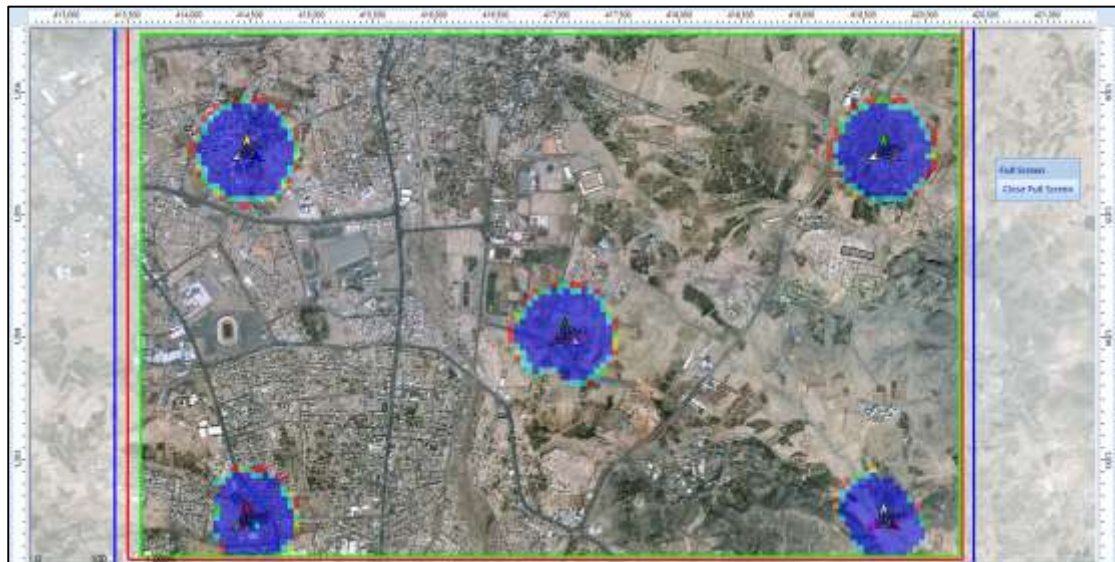
**Figure 4. 36:** prediction histogram of Coverage by Throughput (UL) in LTE technology (After optimization)

It is noticed from the previous figures that there is an enhancement in term of Coverage by Throughput (UL). Good levels such as; 50Mb are available on a

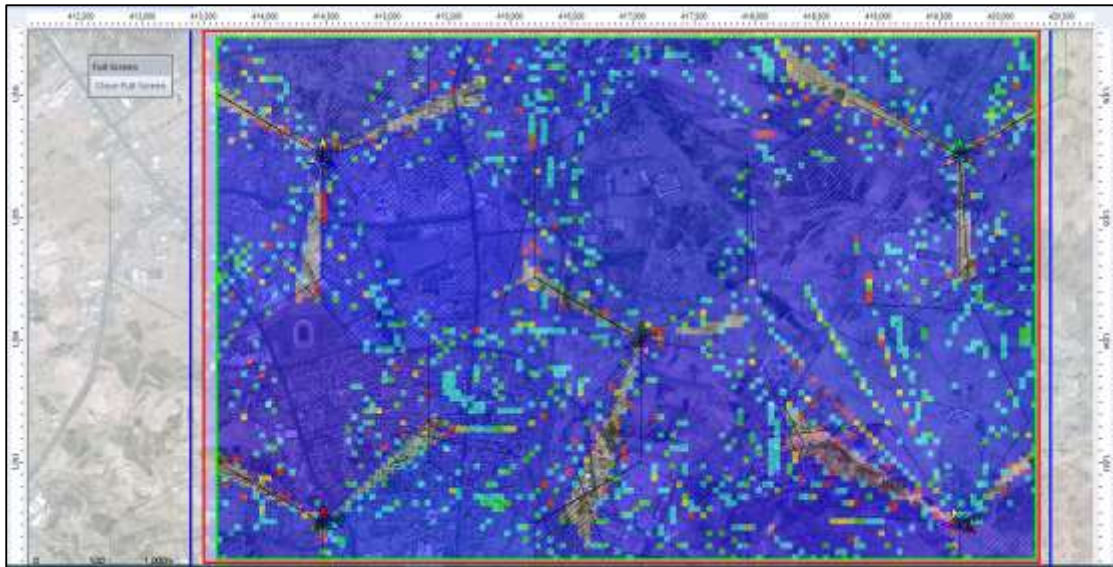
wide range of more than 14km<sup>2</sup> after optimization. Such values were not available at all before optimization process.

#### 4.5.1.12 Coverage by Quality Indicator (DL)

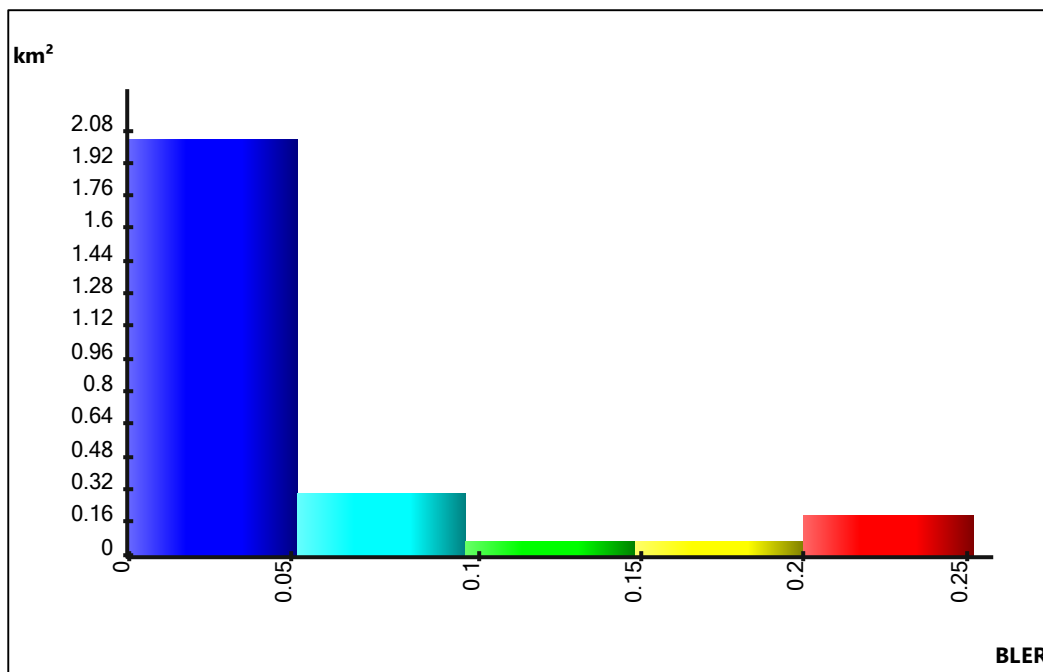
The following figures show the map and histogram prediction results of Coverage by Quality Indicator (DL) in LTE technology. The first figure shows the results before the optimization process that has been done and explained in the previous chapter, and the second figure shows the results after the optimization;



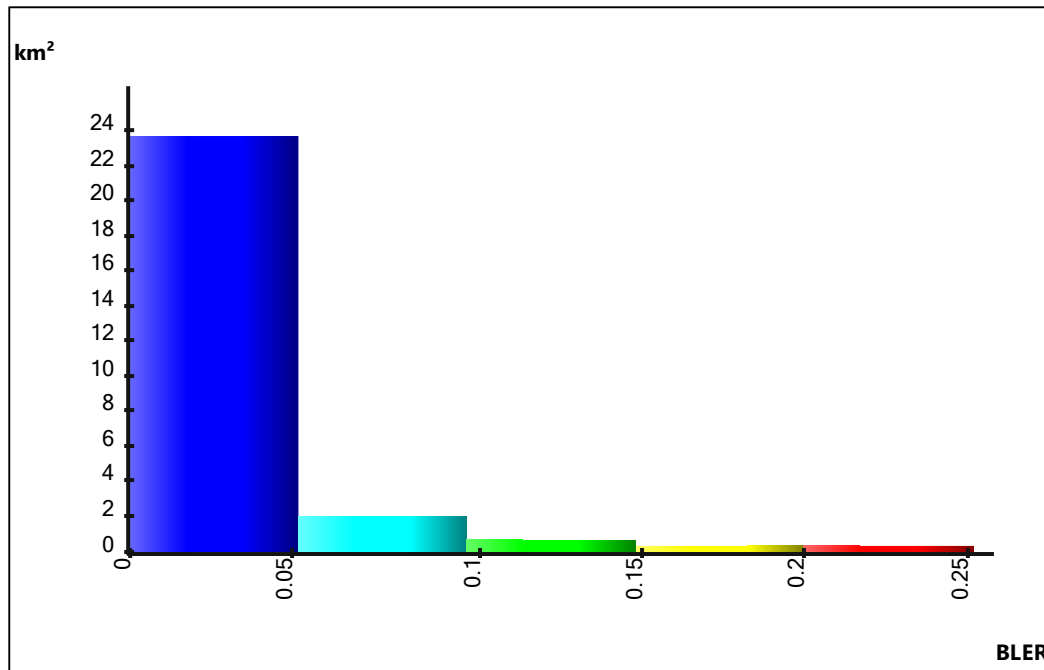
**Figure 4. 37:** prediction result of Coverage by Quality Indicator (DL) in LTE technology (Before optimization)



**Figure 4.38:** prediction result of Coverage by Quality Indicator (DL) in LTE technology (After optimization)



**Figure 4.39:** prediction histogram of Coverage by Quality Indicator (DL) in LTE technology (Before optimization)

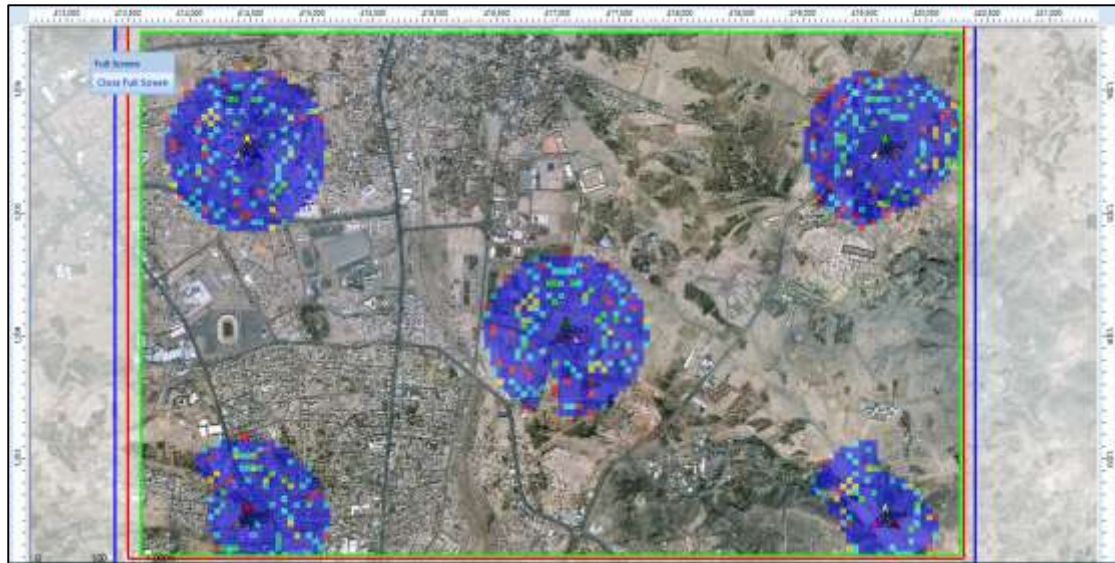


**Figure 4. 40:** prediction histogram of Coverage by Quality Indicator (DL) in LTE technology (After optimization)

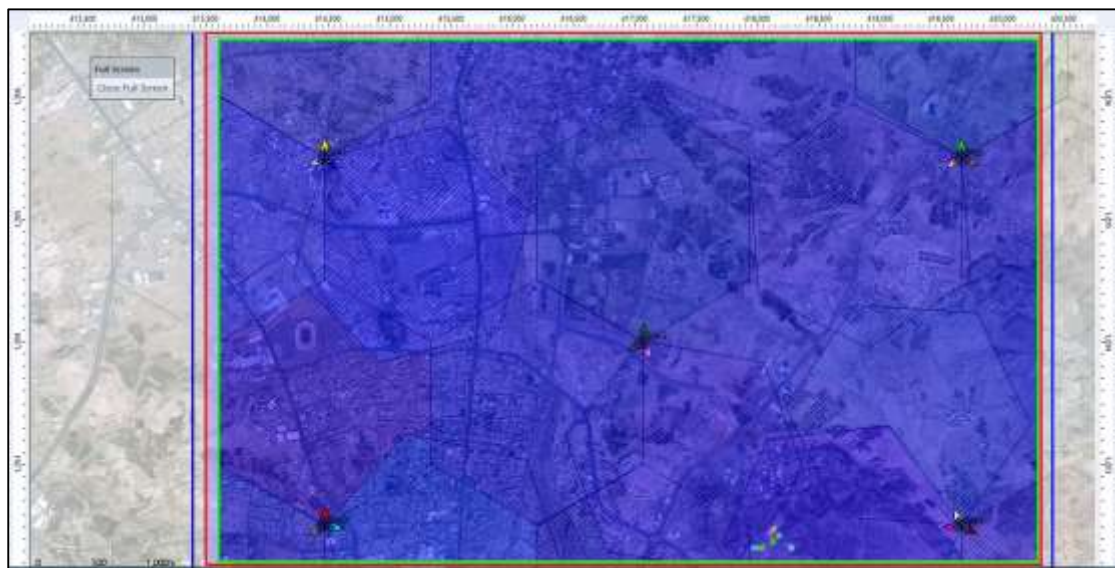
It is noticed from the previous figures that there is an enhancement in term of Quality Indicator (DL). Low BLER (Block Error Rate) values such as 0.05 are available on a wide range of more than 22km<sup>2</sup> after optimization. Such values were available only within a short range that is less than 2km<sup>2</sup> before optimization process. The Block Error Rate read from the subscriber terminal's reception equipment for the C/(I+N) level at the subscriber location in the downlink.

#### 4.5.1.14 Coverage by Quality Indicator (UL)

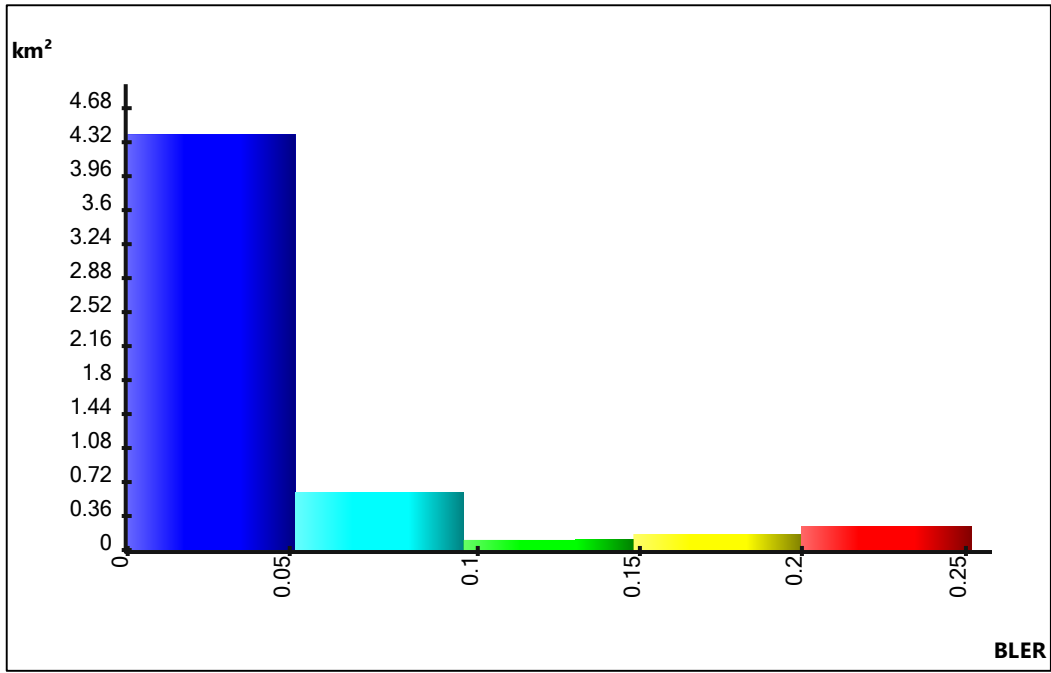
The following figures show the map and histogram prediction results of Coverage by Quality Indicator (UL) in LTE technology. The first figure shows the results before the optimization process that has been done and explained in the previous chapter, and the second figure shows the results after the optimization;



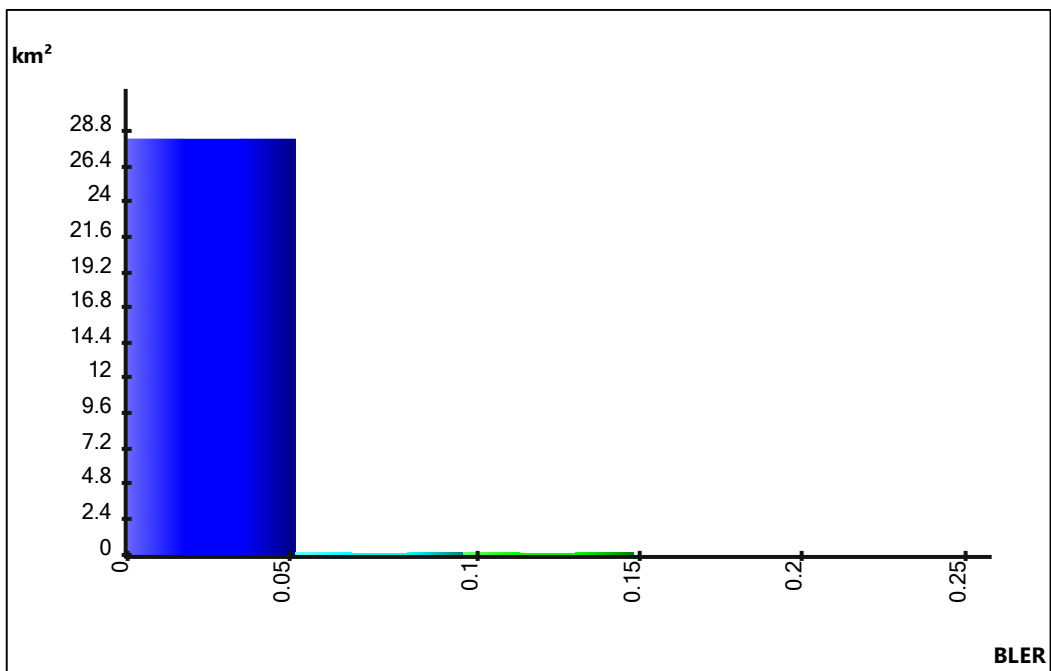
**Figure 4. 41:** prediction result of Coverage by Quality Indicator (UL) in LTE technology (Before optimization)



**Figure 4. 42:** prediction result of Coverage by Quality Indicator (UL) in LTE technology (After optimization)



**Figure 4. 43:** prediction histogram of Coverage by Quality Indicator (UL) in LTE technology (Before optimization)

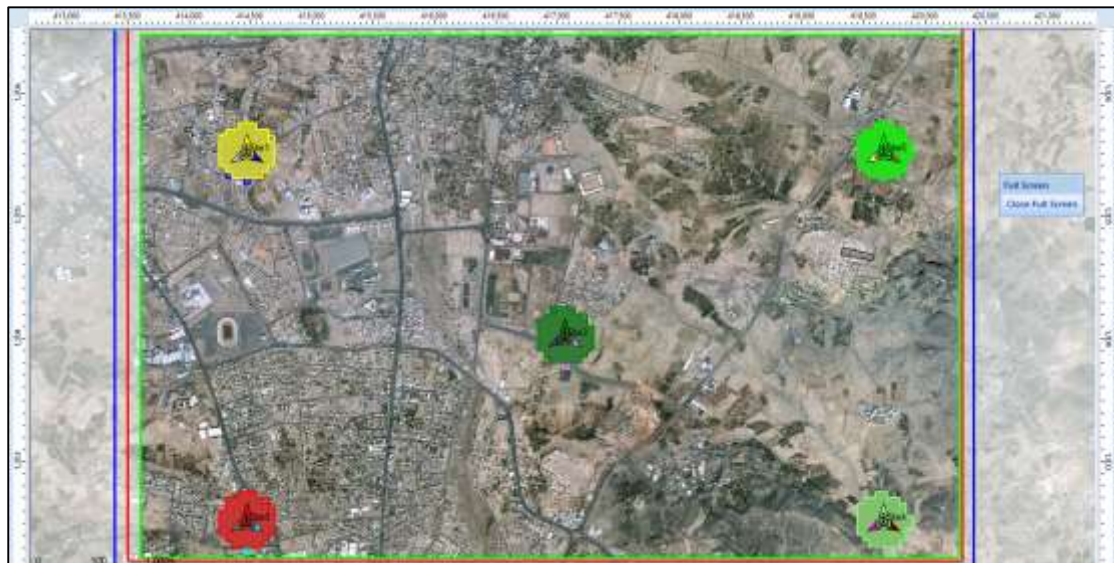


**Figure 4. 44:** prediction histogram of Coverage by Quality Indicator (UL) in LTE technology (After optimization)

It is noticed from the previous figures that there is an enhancement in term of Quality Indicator (UL). Low BLER (Block Error Rate) values such as 0.05 are available on a wide range of more than 26km<sup>2</sup> after optimization. Such values were available only within a short range that is less than 5km<sup>2</sup> before optimization process. The Block Error Rate read from the subscriber terminal's reception equipment for the C/(I+N) level at the subscriber location in the downlink.

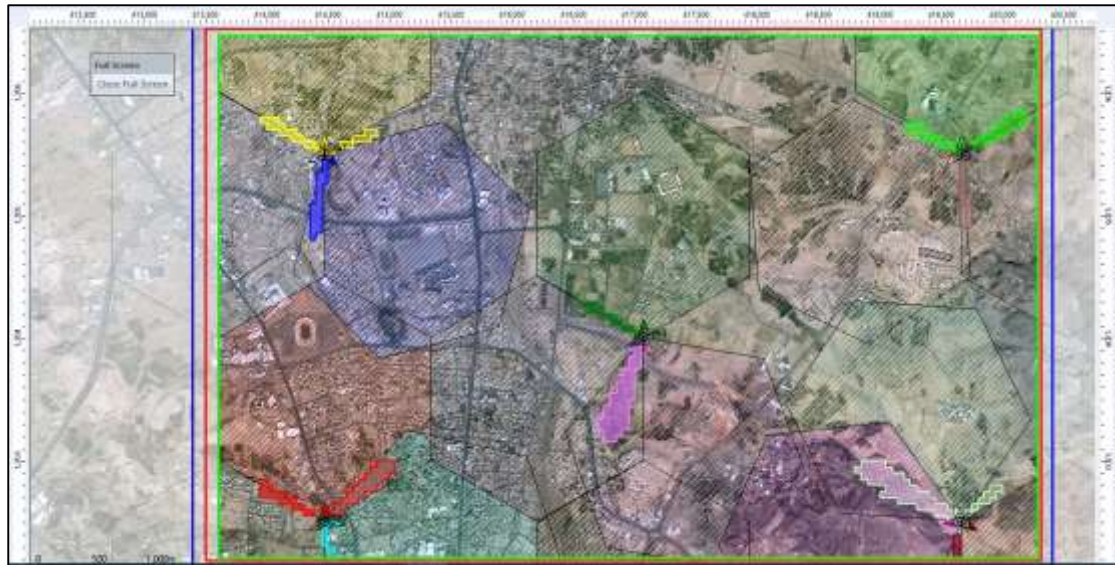
#### 4.5.1.14 Cell Identifier Collision Zones (DL)

The following figures show the prediction result of Cell Identifier Collision Zones (DL) in LTE technology. The first figure shows the results before the optimization process that has been done and explained in the previous chapter, and the second figure shows the results after the optimization;



**Figure 4. 45:** prediction result of Cell Identifier Collision Zones (DL) in LTE technology (Before optimization)



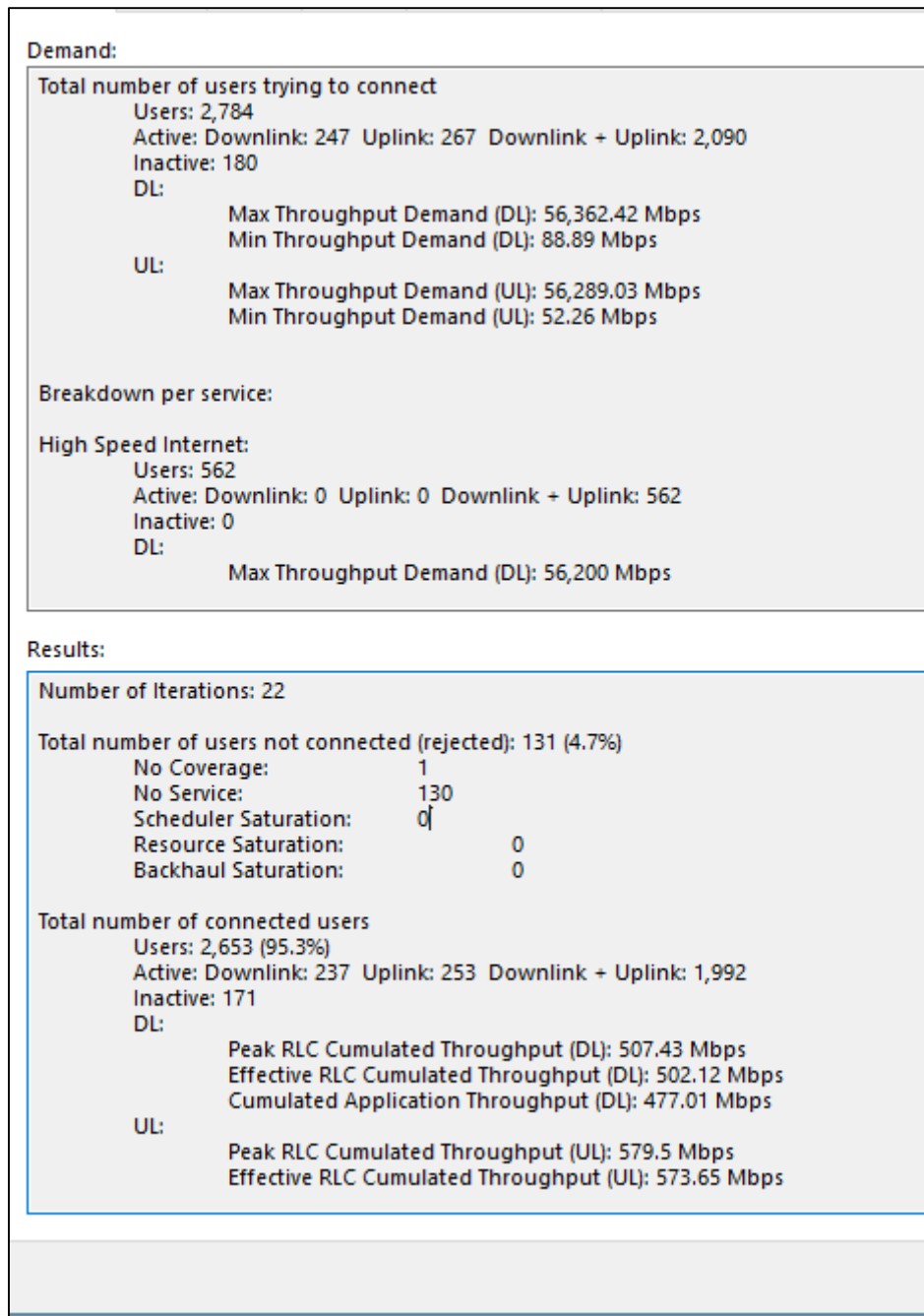


**Figure 4. 46:** prediction result of Cell Identifier Collision Zones (DL) in LTE technology (After optimization)

It is noticed from the previous figures that there is an enhancement in term of Cell Identifier Collision Zones (DL). These zones became significantly narrower than they were before the optimization process. They do not represent a serious problem anymore.

#### **4.5.1.14 Simulation Demands and Results**

The following figures show the Initial Simulation Demands and Results of LTE technology. The first figure shows the results before the optimization process that has been done and explained in the previous chapter, and the second figure shows the results after the optimization;



**Figure 4. 47:** Initial Simulation Demands and Results of LTE technology

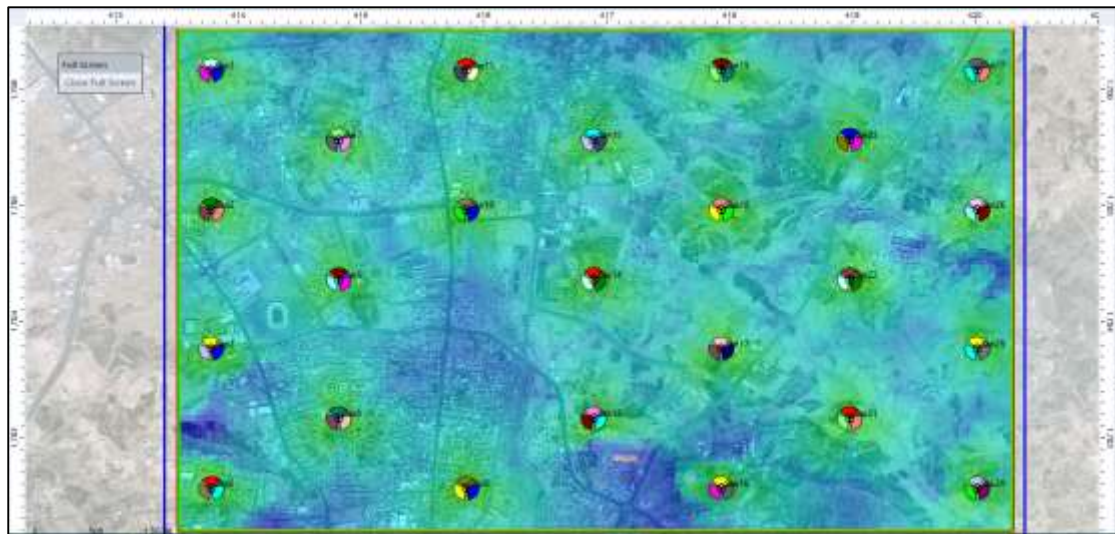
The Final simulation result shows that only 4.7% of the users face problems related to connecting to the network. This percentage is relatively small and is acceptable in practical environment. This result was achieved after a long process that required lots of tests and studies.

## 4.2.2 5G NR

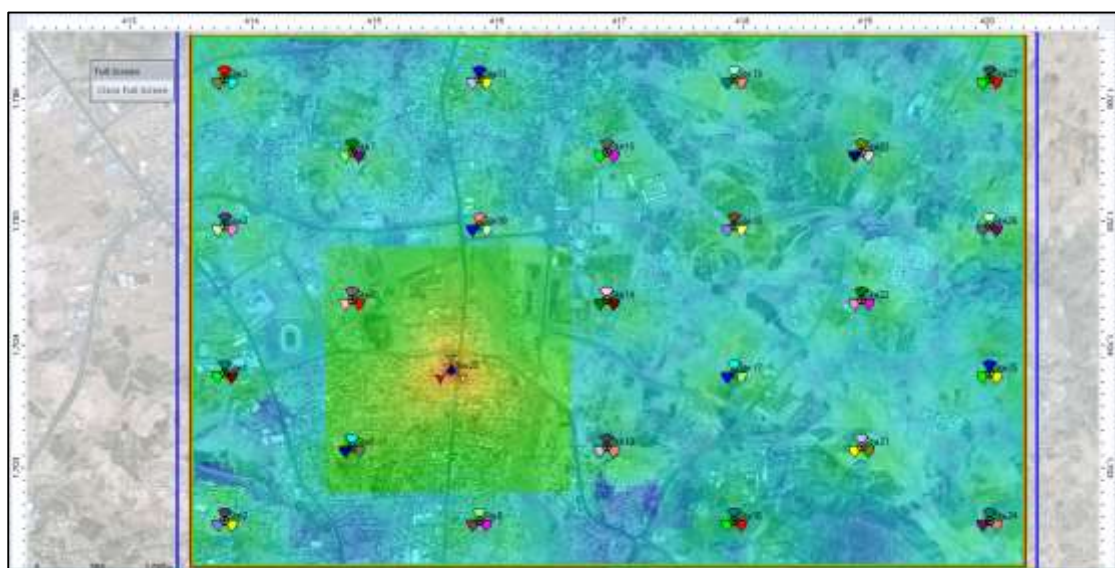
This part deals with results related to LTE technology.

### 4.5.2.1 5G NR: Downlink Coverage

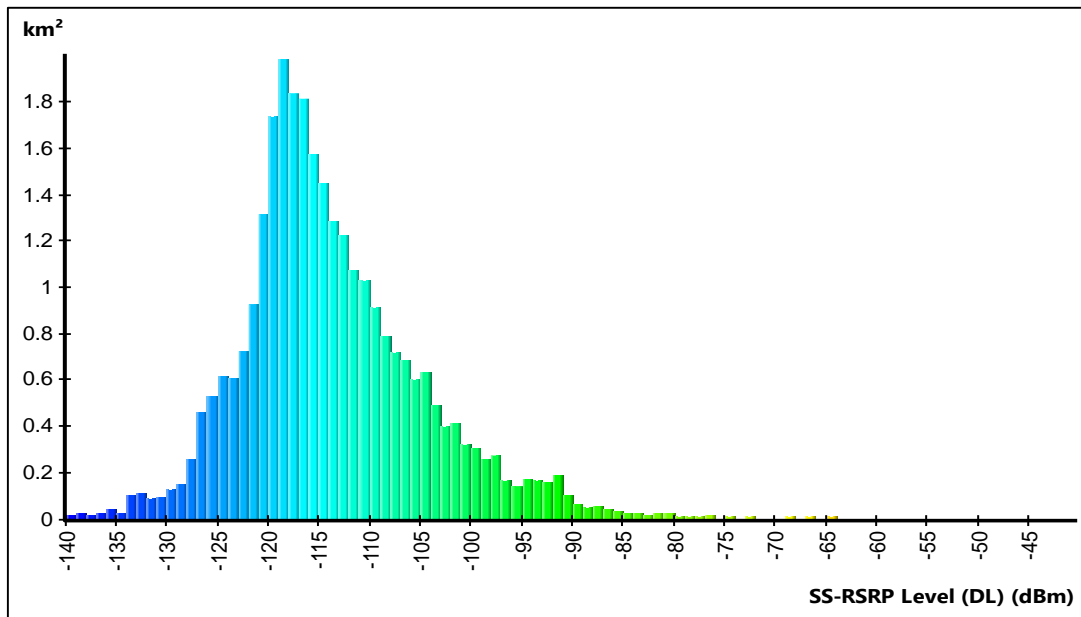
The following figures show the map and histogram prediction results of 5G NR: Downlink Coverage in 5G NR technology. The first figure shows the results before the optimization process that has been done and explained in the previous chapter, and the second figure shows the results after the optimization;



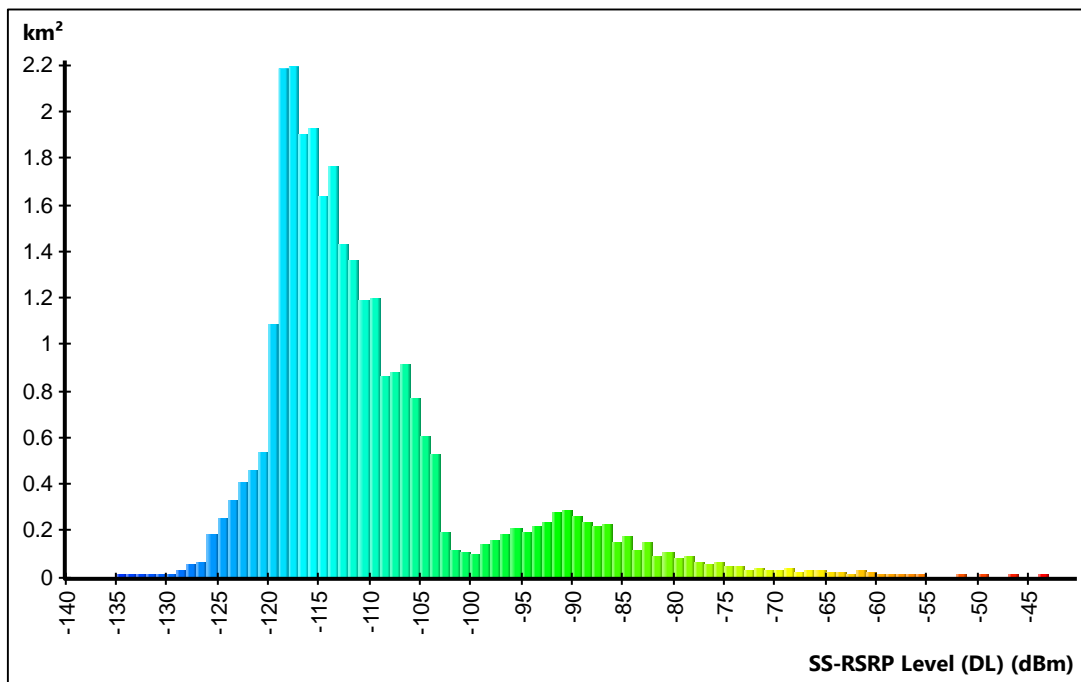
**Figure 4.48:** prediction result of Coverage by Transmitter (DL) in 5G NR technology (Before optimization)



**Figure 4.49:** prediction result of Coverage by Transmitter (DL) in 5G NR technology (After optimization)



**Figure 4. 50:** 5G NR: Downlink Coverage in 5G NR design (Before optimization)



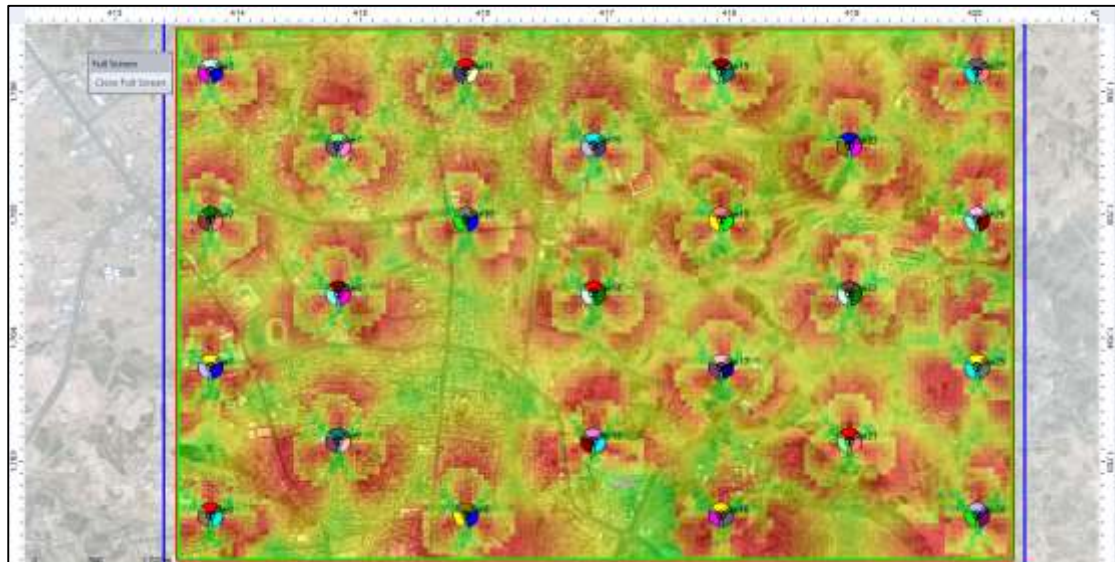
**Figure 4. 51:** 5G NR: Downlink Coverage in 5G NR design (After optimization)

It is noticed from the previous figures that there is an enhancement in term of Signal Level (DL). Good signal levels such as; -100 and -105 became

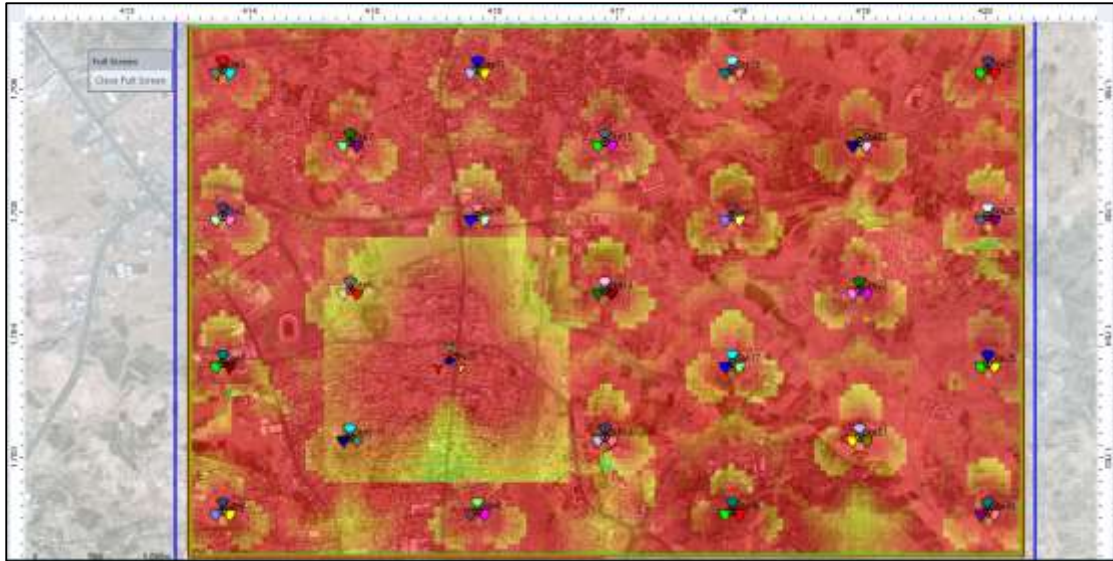
available on a wider range. Before optimization, they were available on a short range of less than 300km<sup>2</sup>, but after optimization, they became available on a wide range of more than 400km<sup>2</sup>.

#### 4.5.2.2 5G NR: Downlink Quality

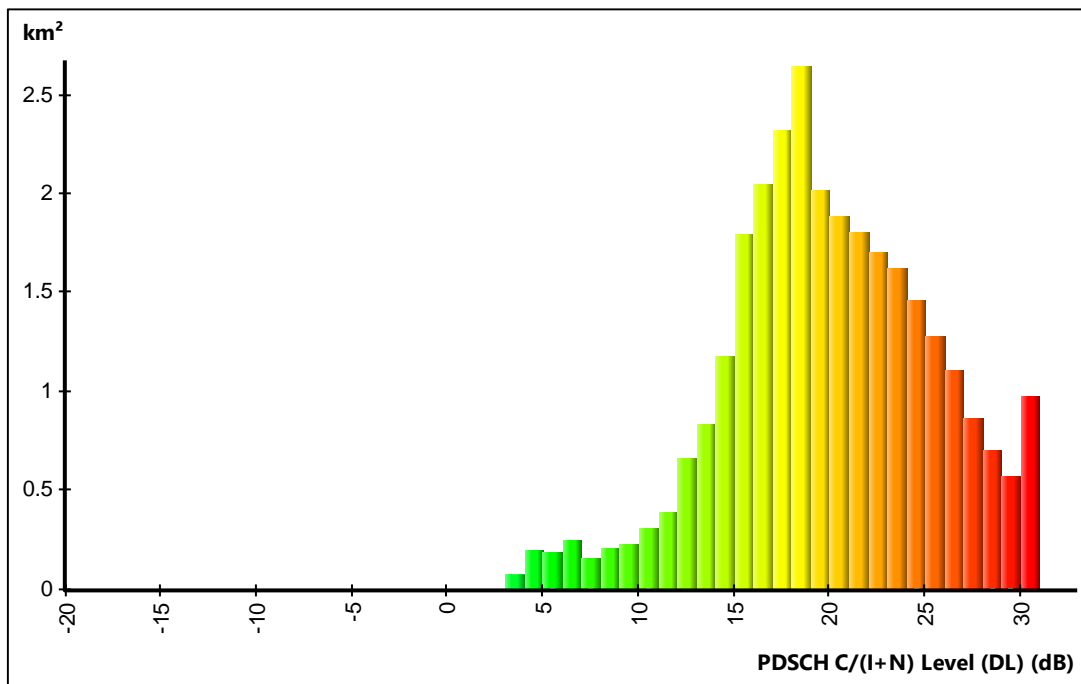
The following figures show the map and histogram prediction results of Coverage by Signal Level (DL) in 5G NR technology. The first figure shows the results before the optimization process that has been done and explained in the previous chapter, and the second figure shows the results after the optimization;



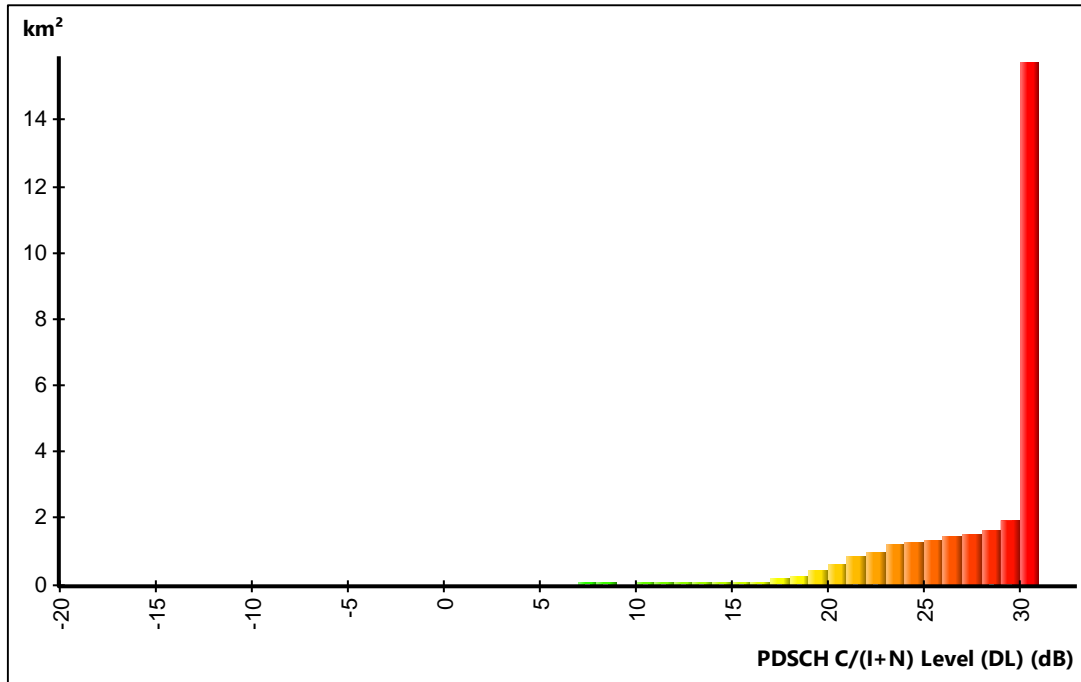
**Figure 4. 52:** prediction result of 5G NR: Downlink Quality in 5G NR technology (Before optimization)



**Figure 4.53:** prediction result of 5G NR: Downlink Quality in 5G NR technology (After optimization)



**Figure 4.54:** prediction histogram of 5G NR: Downlink Quality in 5G NR technology (Before optimization)

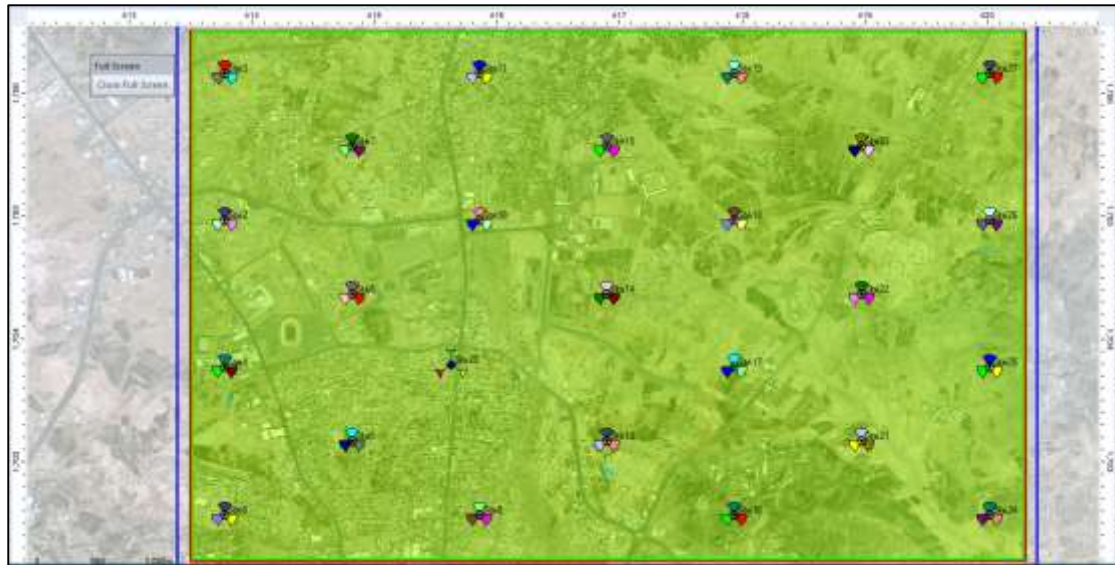


**Figure 4. 55:** prediction histogram of 5G NR: Downlink Quality in 5G NR technology (After optimization)

It is noticed from the previous figures that there is an enhancement in term of Downlink Quality. Good levels such as; 30dB are available on a wide range of more than 14km<sup>2</sup> after optimization. Such values were available within a short range of less than 1km<sup>2</sup> before optimization process.

#### 4.5.2.4 5G NR: Downlink Service Areas

The following figures show the map and histogram prediction results of 5G NR: Downlink Service Areas in 5G NR technology. The first figure shows the results before the optimization process that has been done and explained in the previous chapter, and the second figure shows the results after the optimization;

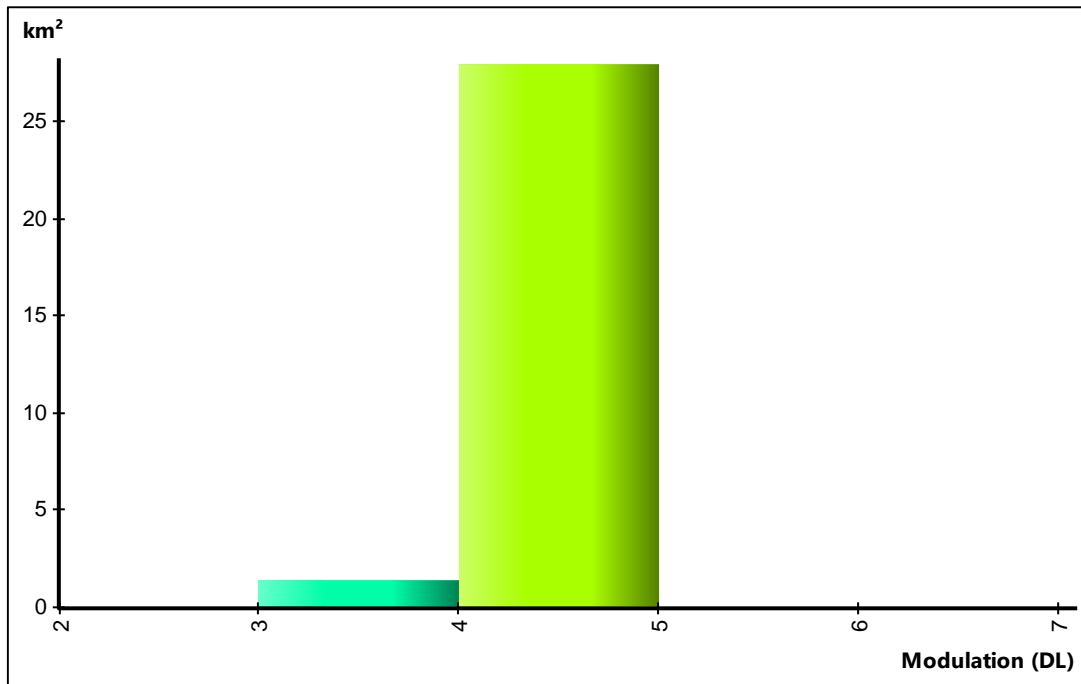


**Figure 4. 56:** prediction result of 5G NR: Downlink Service Areas in 5G NR technology (Before optimization)

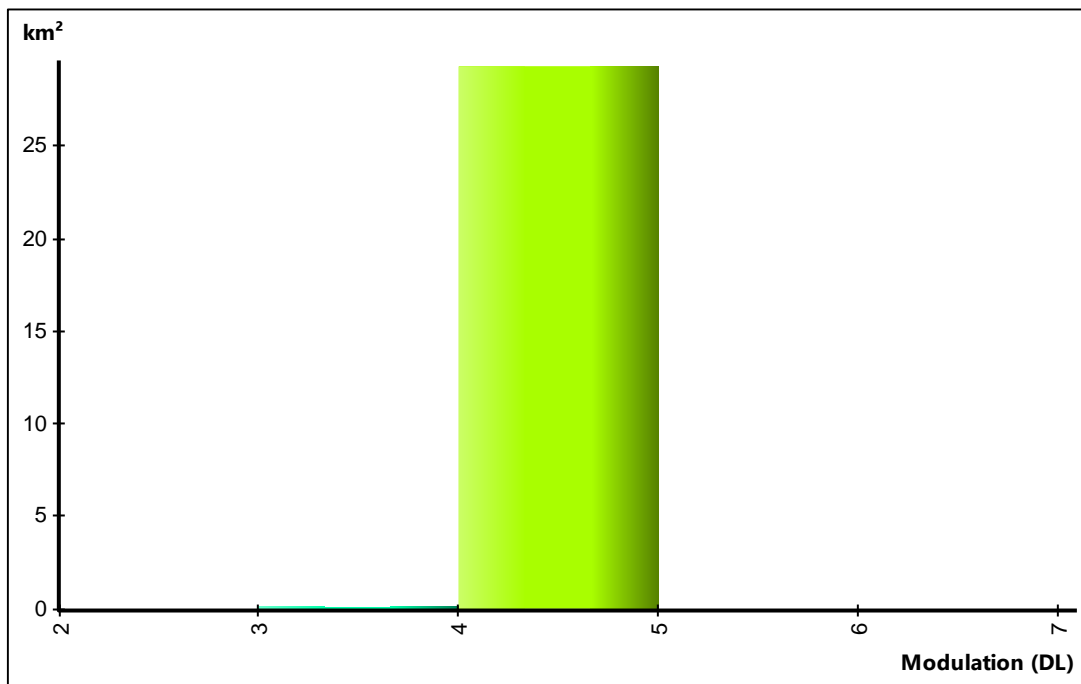


**Figure 4. 57:** prediction result of 5G NR: Downlink Service Areas in 5G NR technology (After optimization)





**Figure 4. 58:** prediction histogram of 5G NR: Downlink Service Areas in 5G NR technology (Before optimization)



**Figure 4. 59:** prediction histogram of 5G NR: Downlink Service Areas in 5G NR technology (After optimization)

It is noticed from the previous figures that there is an enhancement in term of Downlink Service Areas. Higher modulation schemes became available to be used within the covered area.

#### 4.5.2.4 5G NR: Downlink Capacity

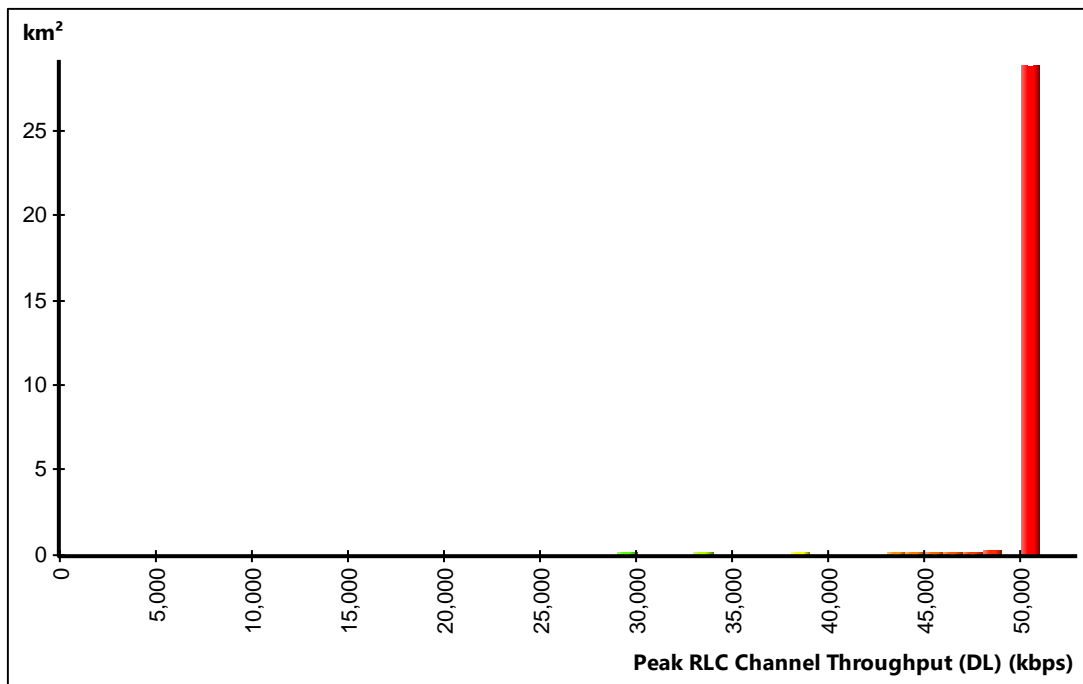
The following figures show the map and histogram prediction results of 5G NR: Downlink Capacity in 5G NR technology. The first figure shows the results before the optimization process that has been done and explained in the previous chapter, and the second figure shows the results after the optimization;



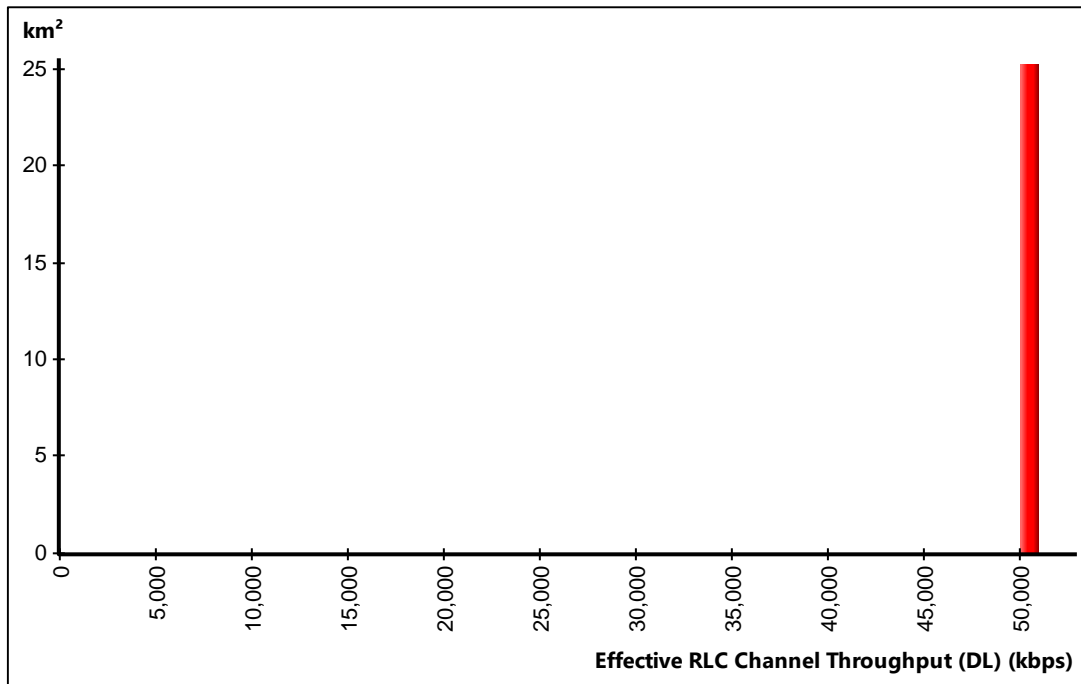
**Figure 4. 60:** prediction result of 5G NR: Downlink Capacity in 5G NR technology (Before optimization)



**Figure 4. 61:** prediction result of 5G NR: Downlink Capacity in 5G NR technology (After optimization)



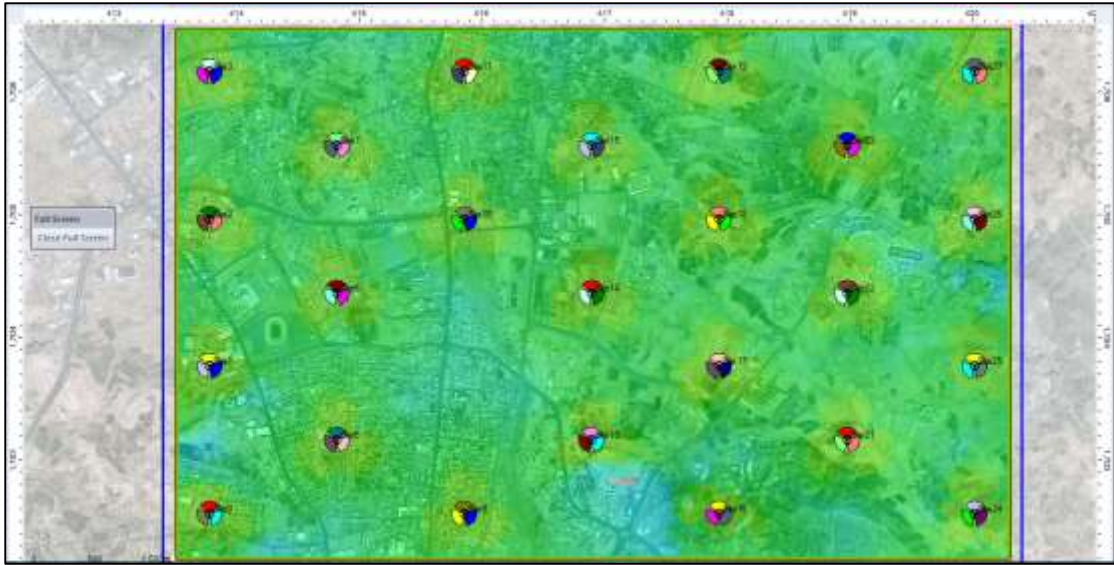
**Figure 4. 62:** prediction histogram of 5G NR: Downlink Capacity in 5G NR technology (Before optimization)



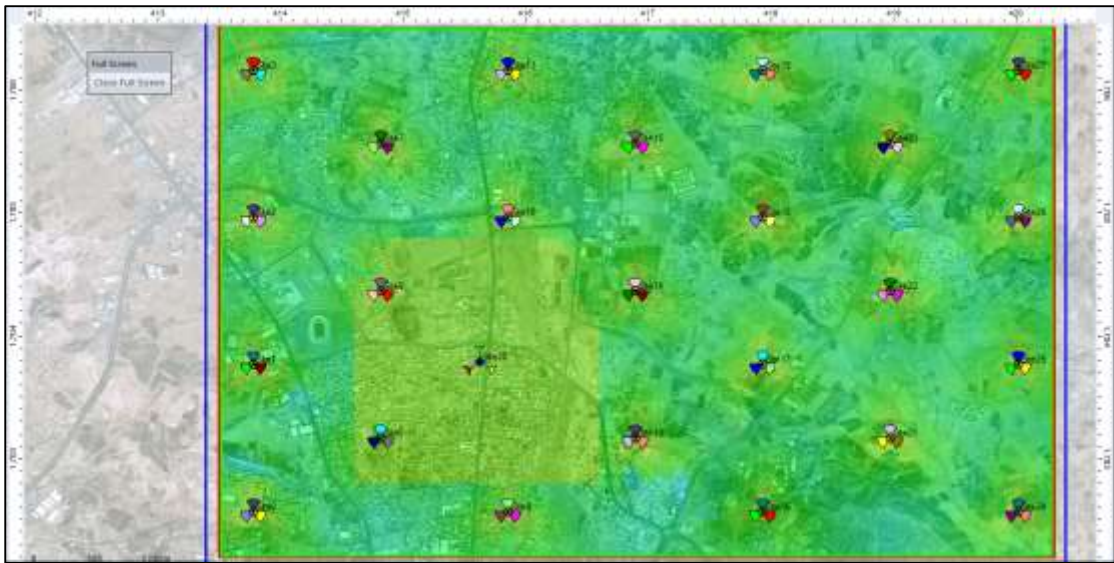
**Figure 4. 63:** prediction histogram of 5G NR: Downlink Capacity in 5G NR technology (After optimization)

#### 4.5.2.5 5G NR: Uplink Coverage

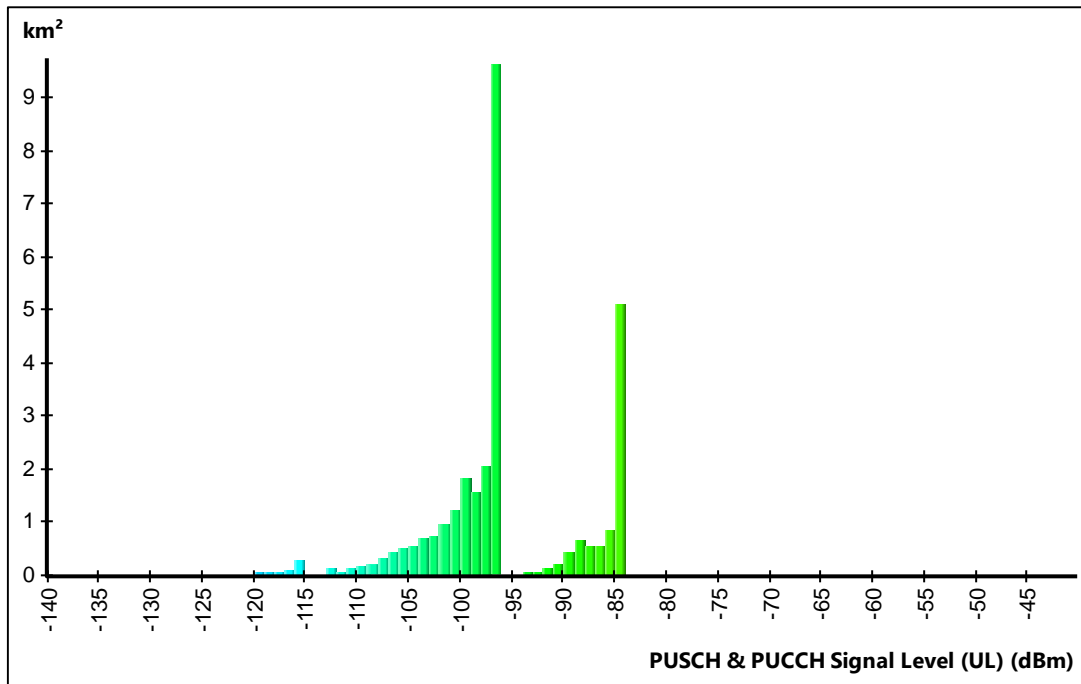
The following figures show the map and histogram prediction results of 5G NR: Uplink Coverage in 5G NR technology. The first figure shows the results before the optimization process that has been done and explained in the previous chapter, and the second figure shows the results after the optimization;



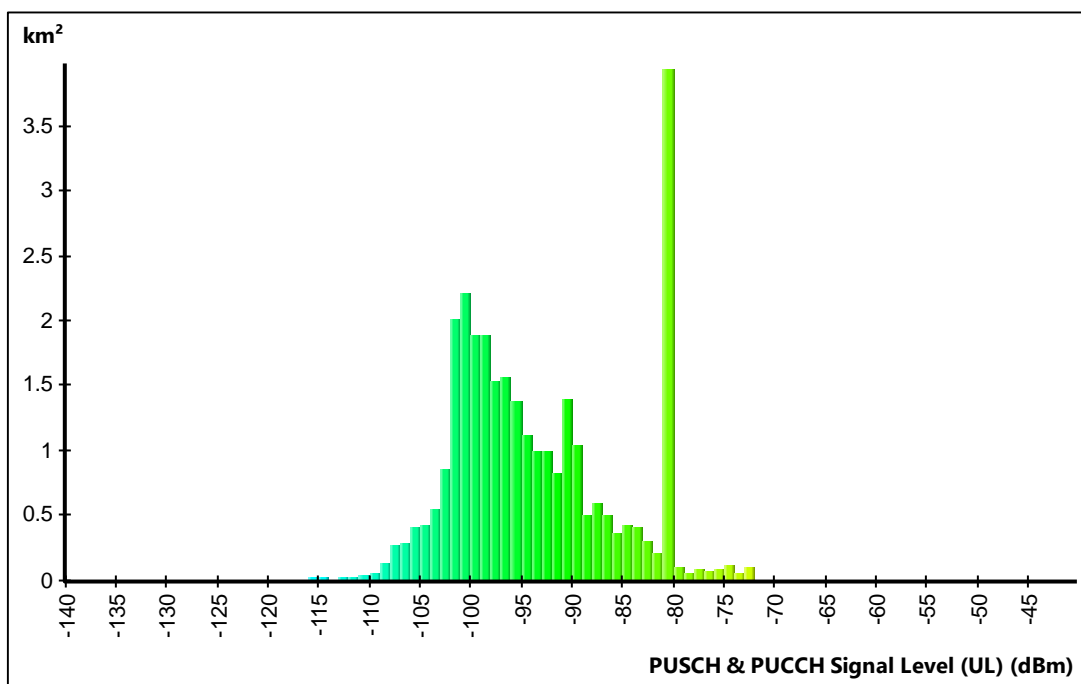
**Figure 4. 64:** prediction result of 5G NR: Uplink Coverage in 5G NR technology (Before optimization)



**Figure 4. 65:** prediction result of 5G NR: Uplink Coverage in 5G NR technology (After optimization)



**Figure 4. 66:** prediction histogram of 5G NR: Uplink Coverage in 5G NR technology (Before optimization)

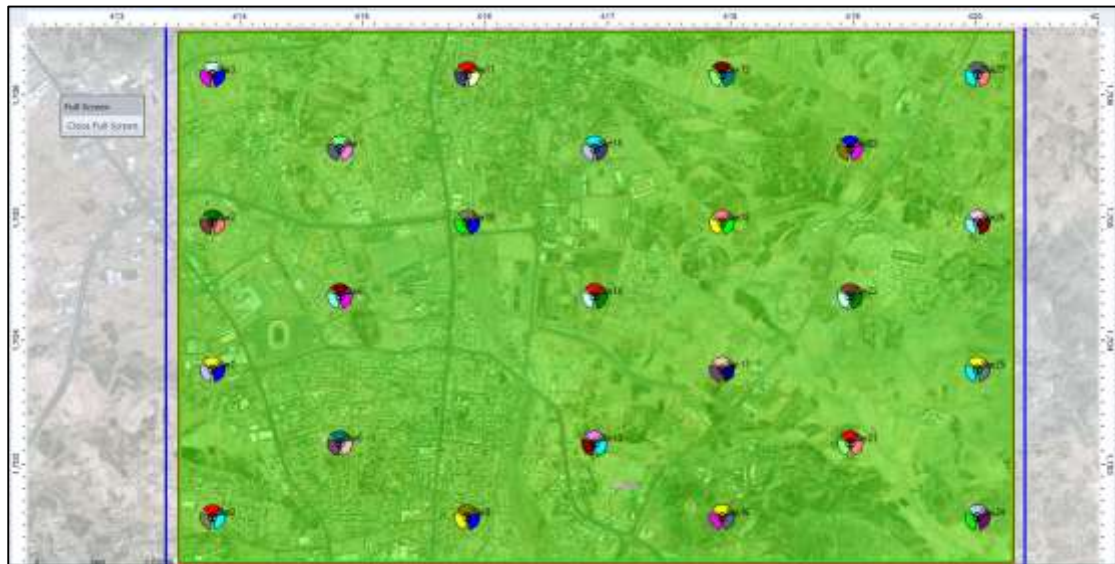


**Figure 4. 67:** prediction histogram of 5G NR: Uplink Coverage in 5G NR technology (After optimization)

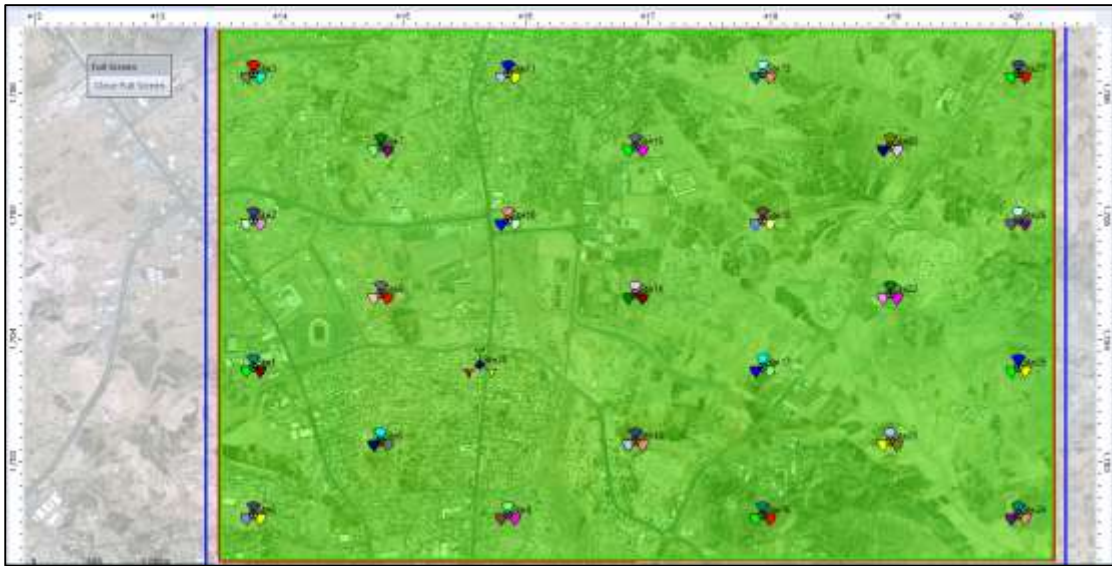
It is noticed from the previous figures that there is an enhancement in term of Uplink Coverage. Good levels such as 80dB are available on a wide range of more than 3.5km<sup>2</sup> after optimization. Such values were not available at all before optimization process.

#### 4.5.2.7 5G NR: Uplink Quality

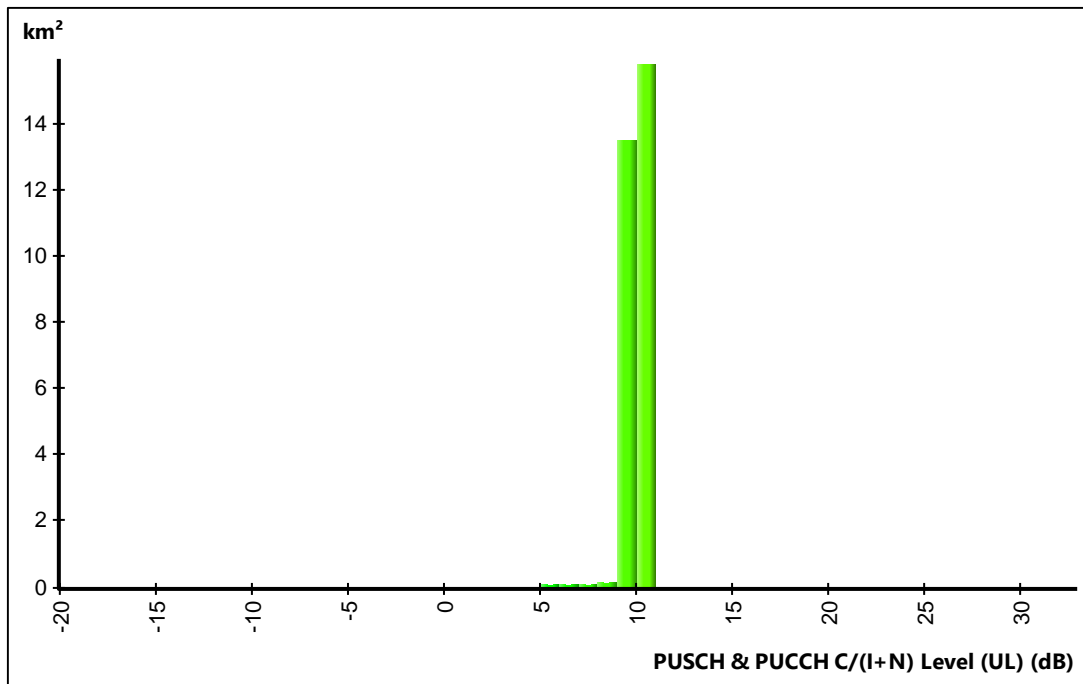
The following figures show the map and histogram prediction results of 5G NR: Uplink Quality in 5G NR technology. The first figure shows the results before the optimization process that has been done and explained in the previous chapter, and the second figure shows the results after the optimization;



**Figure 4. 68:** prediction result of 5G NR: Uplink Quality in 5G NR technology (Before optimization)

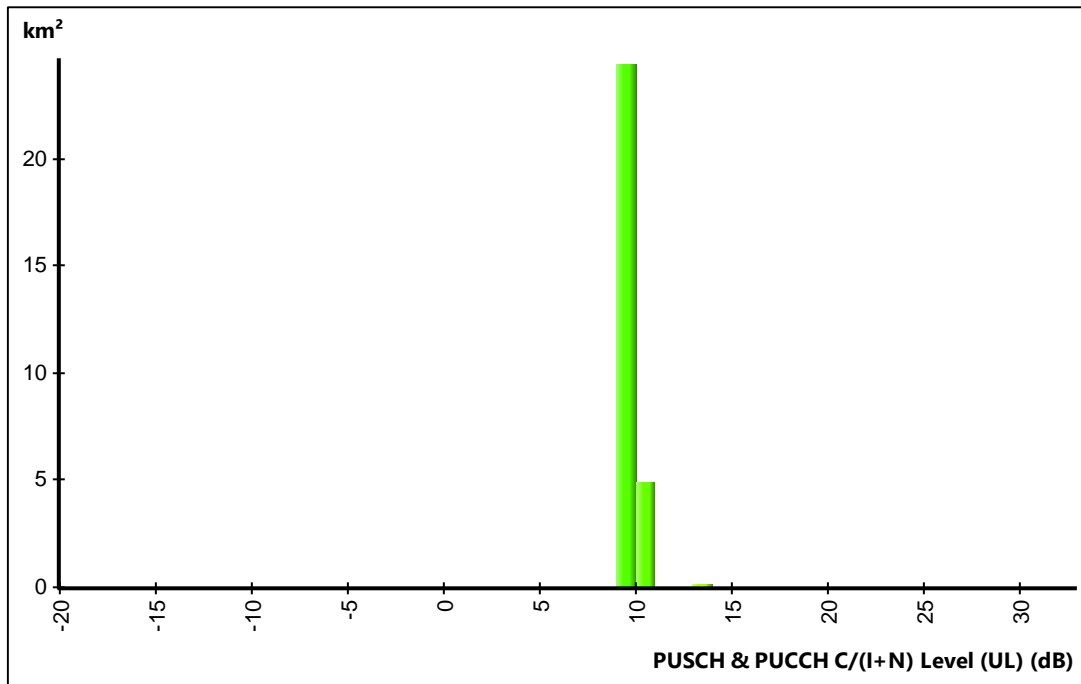


**Figure 4. 69:** prediction result of 5G NR: Uplink Quality in 5G NR technology (After optimization)



**Figure 4. 70:** prediction histogram of 5G NR: Uplink Quality in 5G NR technology (Before optimization)



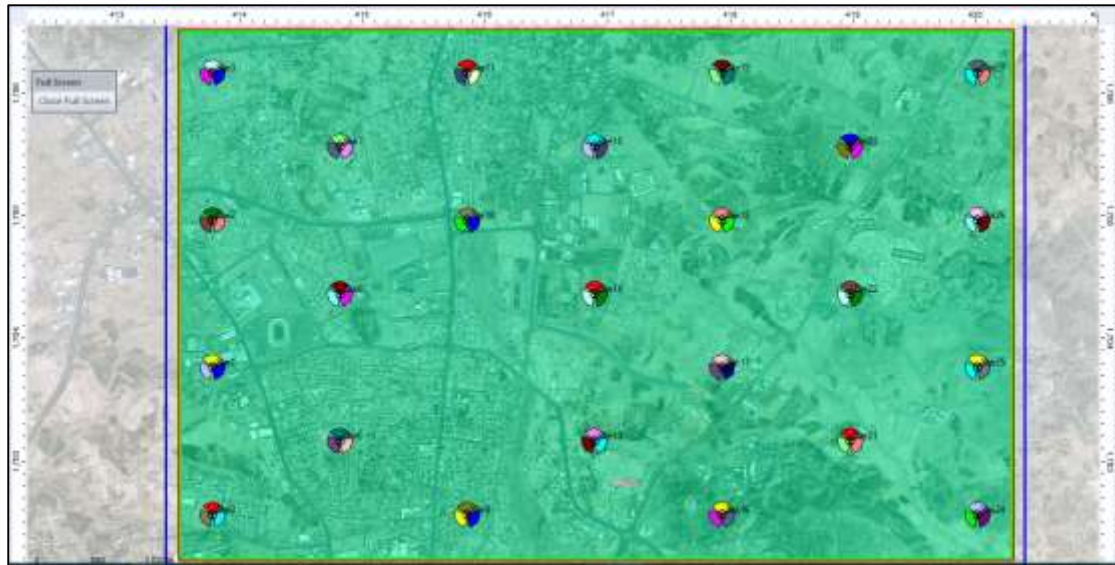


**Figure 4. 71:** prediction histogram of 5G NR: Uplink Quality in 5G NR technology (After optimization)

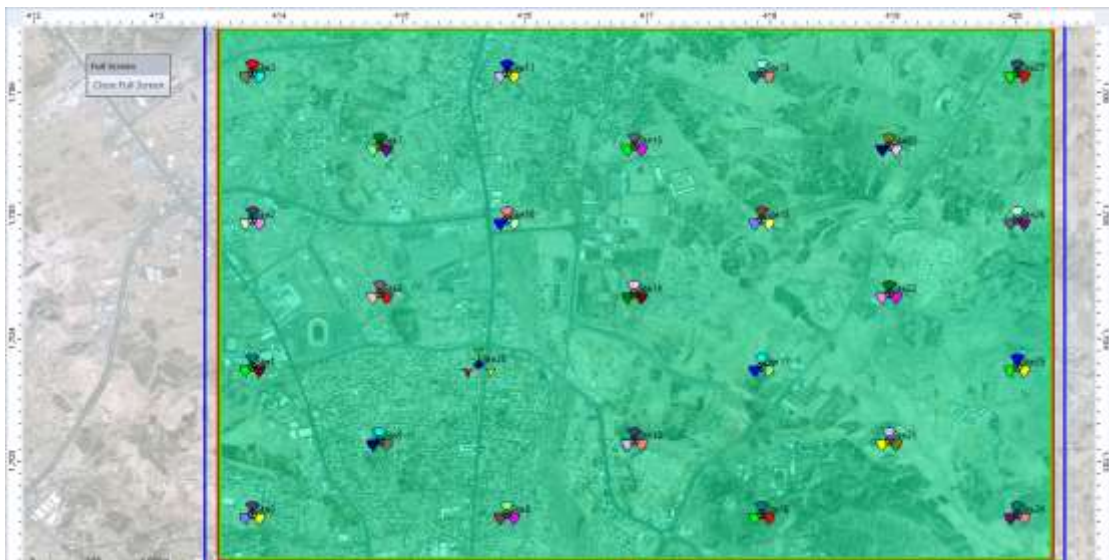
It is noticed from the previous figures that there is an enhancement in term of *Uplink Quality*. Good levels such as 10dB are available on a wide range of more than 20km<sup>2</sup> after optimization. Such values were available before optimization process but within a short range of less than 14km<sup>2</sup>.

#### 4.5.2.8 5G NR: Uplink Service Areas

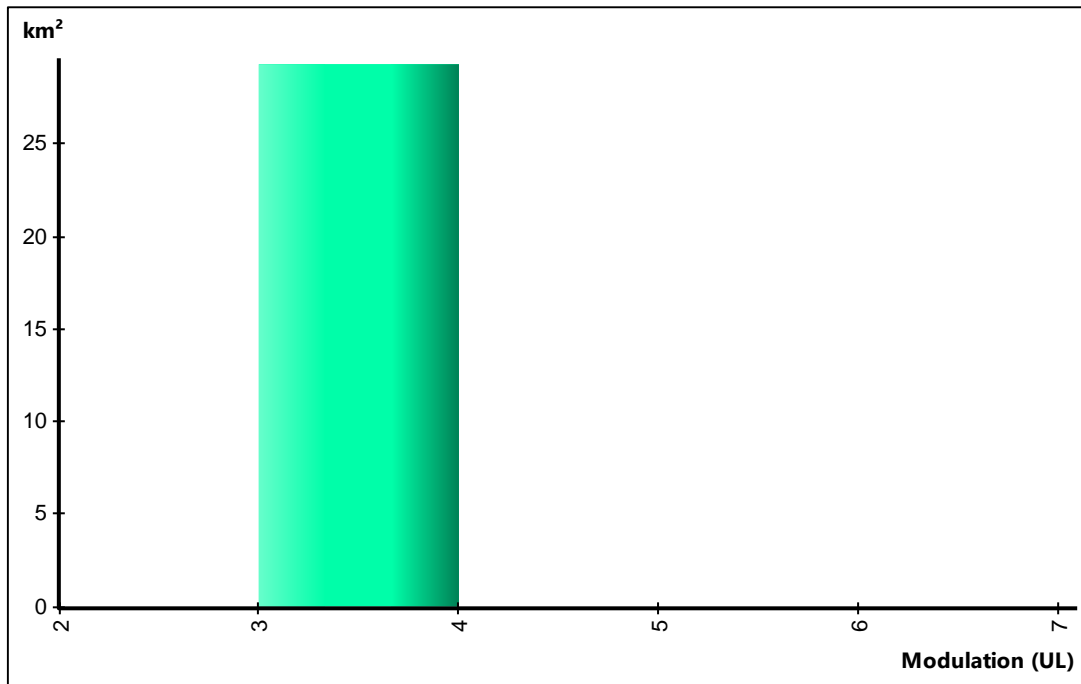
The following figures show the map and histogram prediction results of 5G NR: Uplink Service Areas in 5G NR technology. The first figure shows the results before the optimization process that has been done and explained in the previous chapter, and the second figure shows the results after the optimization;



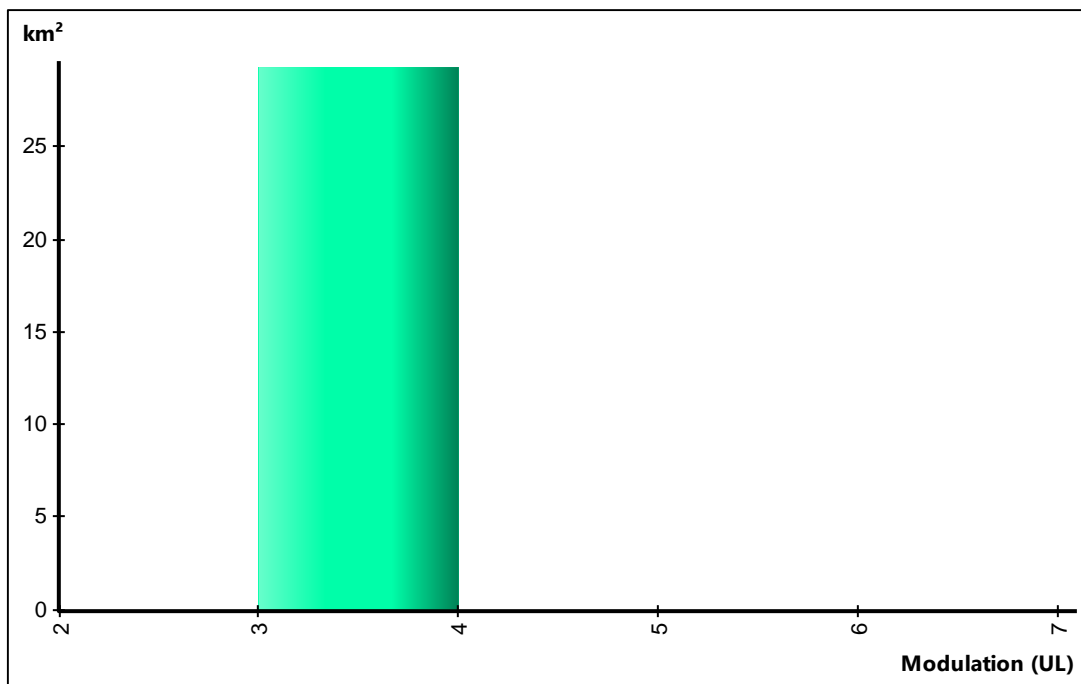
**Figure 4.72:** prediction result of 5G NR: Uplink Service Areas in 5G NR technology (Before optimization)



**Figure 4.73:** prediction result of 5G NR: Uplink Service Areas in 5G NR technology (After optimization)



**Figure 4. 74:** prediction histogram of 5G NR: Uplink Service Areas in 5G NR technology (Before optimization)

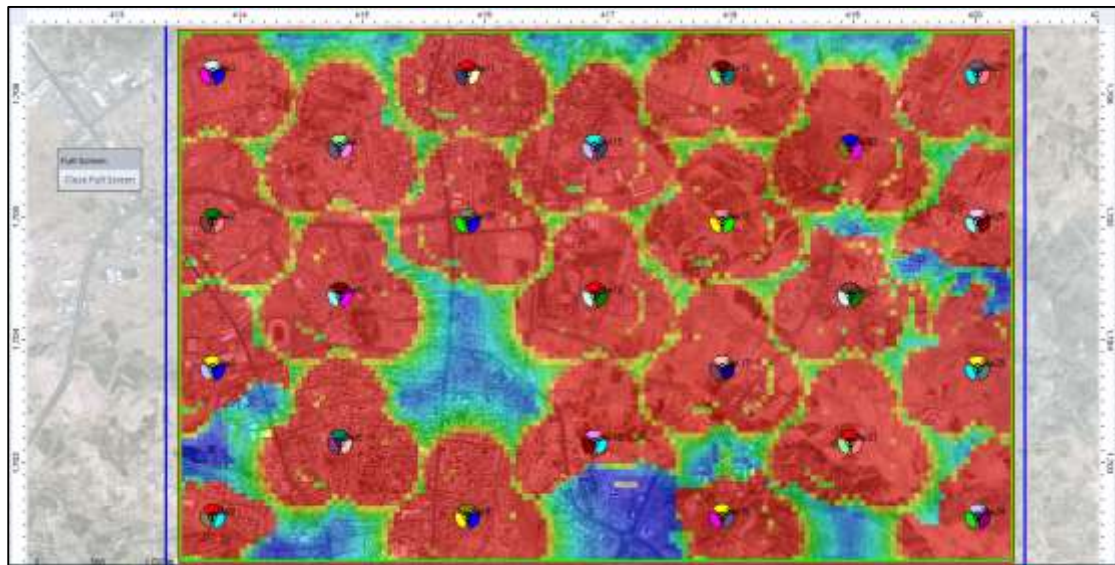


**Figure 4. 75:** prediction histogram of 5G NR: Uplink Service Areas in 5G NR technology (After optimization)

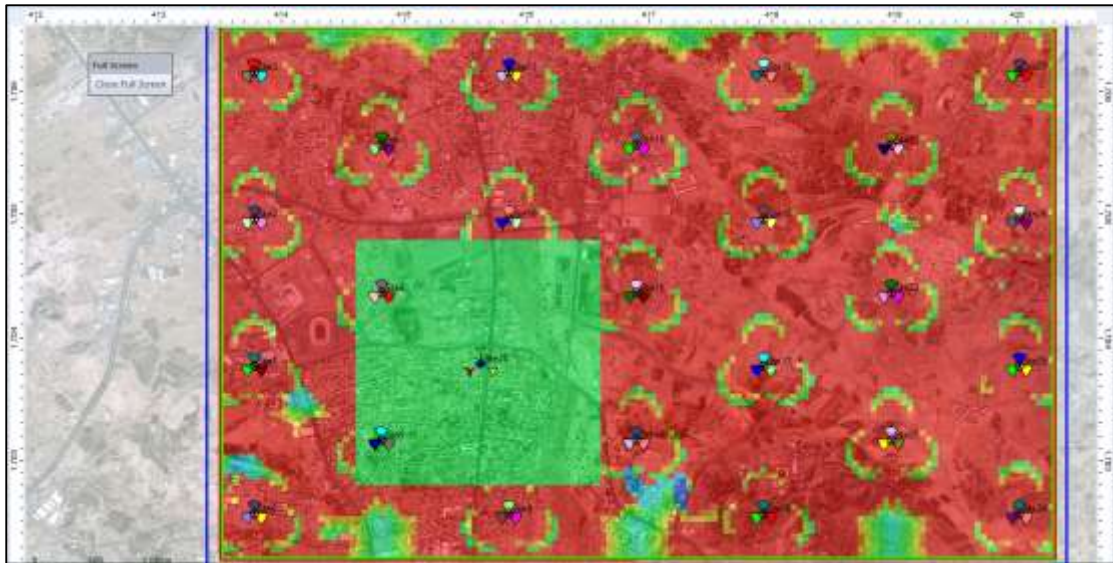
Results related to Uplink Service Areas did not really change a lot after the optimization process.

#### 4.5.2.9 5G NR: Uplink Capacity

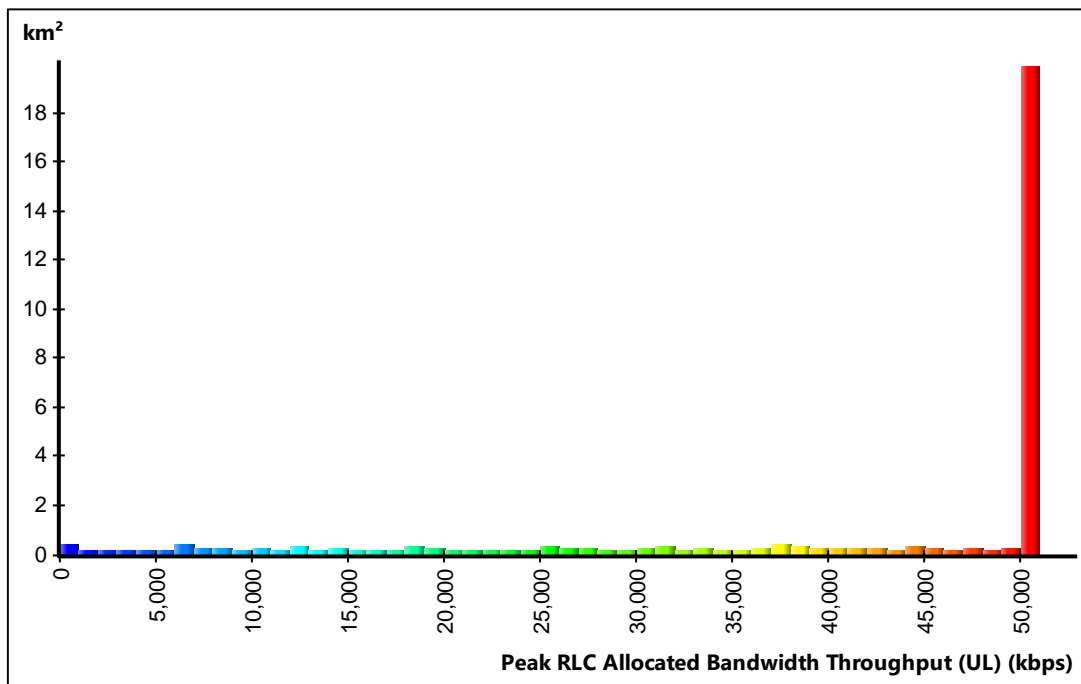
The following figures show the map and histogram prediction results of 5G NR: Uplink Capacity in 5G NR technology. The first figure shows the results before the optimization process that has been done and explained in the previous chapter, and the second figure shows the results after the optimization;



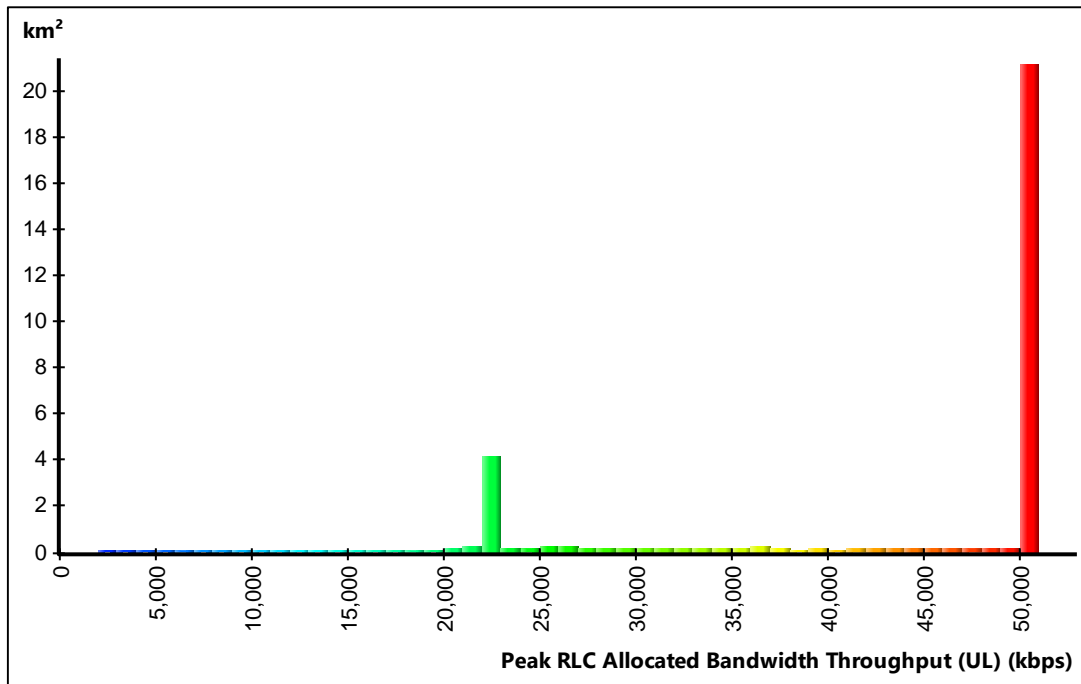
**Figure 4. 76:** prediction result of 5G NR: Uplink Capacity in 5G NR technology (Before optimization)



**Figure 4. 77:** prediction result of 5G NR: Uplink Capacity in 5G NR technology (After optimization)



**Figure 4. 78:** prediction histogram of 5G NR: Uplink Capacity in 5G NR technology (Before optimization)



**Figure 4. 79:** prediction histogram of 5G NR: Uplink Capacity in 5G NR technology (After optimization)

It is noticed from the previous figures that there is an enhancement in term of Coverage by Throughput (UL). Good levels such as; 50Mb are available on a wide range of more than 20km<sup>2</sup> after optimization. Such values were available before optimization process but within a short range of less than 18km<sup>2</sup>.

#### 4.5.2.10 Effective Service Area Analysis (DL+UL)

The following figures show the map result of Effective Service Area Analysis (DL+UL) in 5G NR technology. The first figure shows the results before the optimization process that has been done and explained in the previous chapter, and the second figure shows the results after the optimization;



**Figure 4. 80:** prediction result of Effective Service Area Analysis (DL+UL) in 5G NR technology (Before optimization)



**Figure 4. 81:** prediction result of Effective Service Area Analysis (DL+UL) in 5G NR technology (After optimization)

Results related to Effective Service Area Analysis (DL+UL) did not really change a lot after the optimization process. This is logical since there were enough base stations deployed since the beginning. The only concern was about improving other performance factors.

#### 4.5.2.11 Coverage by Throughput (DL)

The following figures show the map and histogram prediction results of Coverage by Throughput (DL) in 5G NR technology. The first figure shows the results before the optimization process that has been done and explained in the previous chapter, and the second figure shows the results after the optimization;

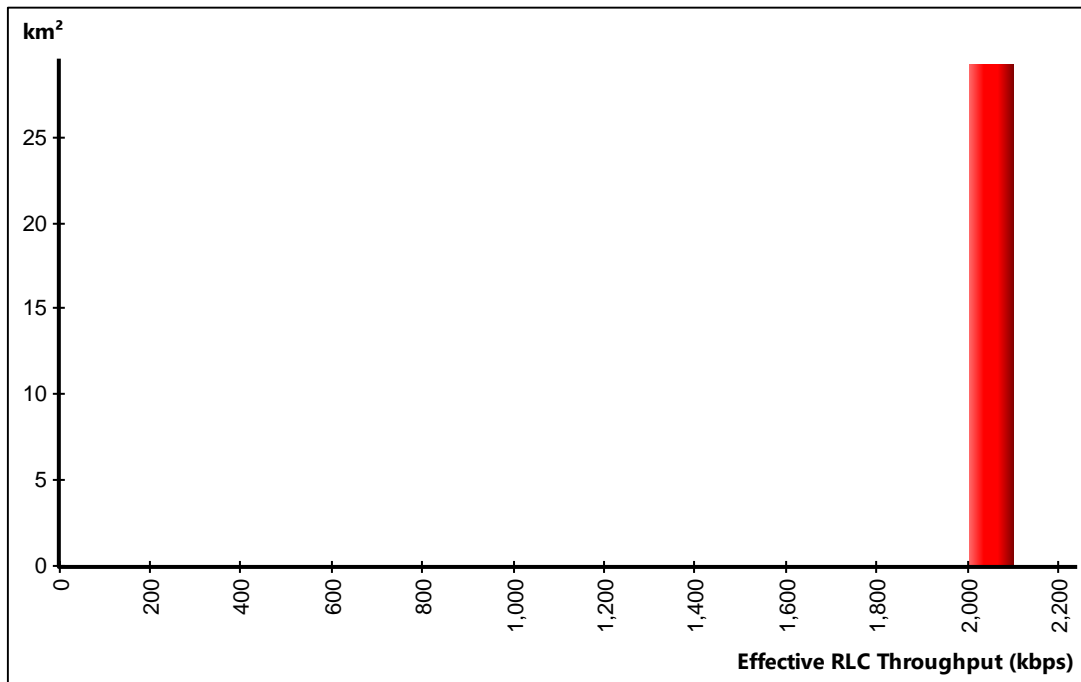


**Figure 4. 82:** prediction result of Coverage by Throughput (DL) in 5G NR technology (Before optimization)

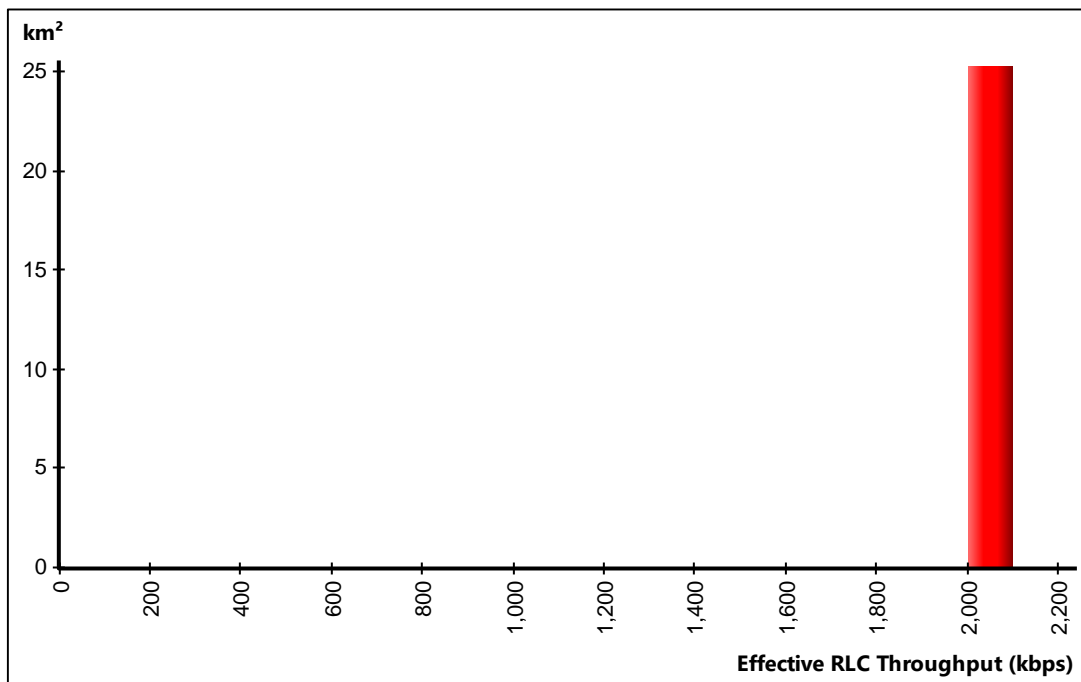


**Figure 4. 83:** prediction result of Coverage by Throughput (DL) in 5G NR technology (After optimization)





**Figure 4. 84:** prediction histogram of Coverage by Throughput (DL) in 5G NR technology (Before optimization)



**Figure 4. 85:** prediction histogram of Coverage by Throughput (DL) in 5G NR technology (After optimization)

The RLC (Radio Link Control) levels did not change a lot. Radio link control (RLC) is a layer 2 Radio Link Protocol used in UMTS, LTE and 5G on the Air interface. This protocol is specified by 3GPP in TS 25.322 for UMTS, TS 36.322 for LTE and TS 38.322 for 5G New Radio (NR). RLC is located on top of the 3GPP MAC-layer and below the PDCP-layer.

#### 4.5.2.14 Simulation Demands and Results

The following figures show the Initial Simulation Demands and Results of 5G NR technology. The first figure shows the results before the optimization process that has been done and explained in the previous chapter, and the second figure shows the results after the optimization;

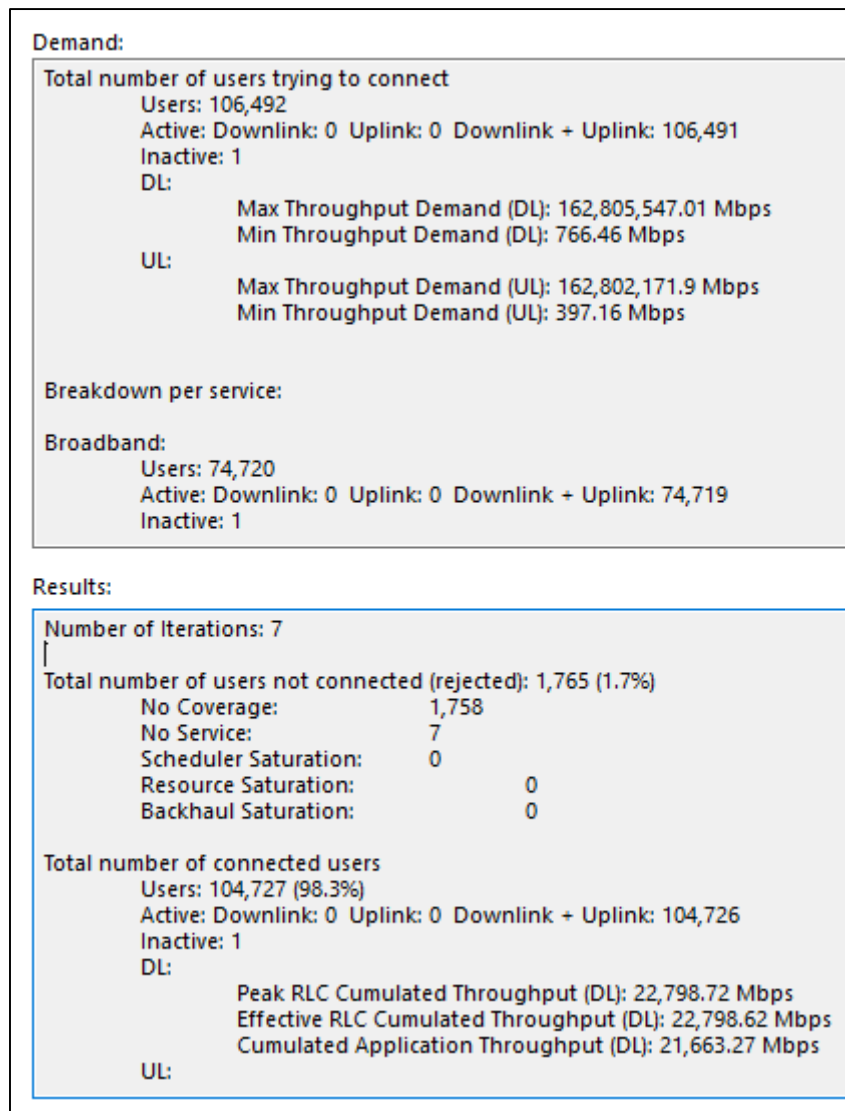


Figure 4. 86: Initial Simulation Demands and Results of 5G NR technology

The Final simulation result shows that only 1.7% of the users face problems related to connecting to the network. This percentage is relatively small and is acceptable in practical environment. This result was achieved after a long process that required lots of tests and studies.

## **CHAPTER FIVE**

# **RESULTS, RECOMMENDATIONS AND FUTURE RESEARCH PERSPECTIVES**

# CHAPTER FIVE

## RESULTS, RECOMMENDATIONS AND FUTURE RESEARCH PERSPECTIVES

### 5.1 Introduction

The fifth chapter provides a list of findings and a list of practical recommendations that were adopted according to the results of the optimization and simulation process. The second part of the chapter provides a list of suggestions of future works and studies that can help to develop better perspectives of the current topic and other related topics.

### 5.1 Results

The study has come up with the following findings;

- Deploying 5G NR networks requires a cost and an effort that is much higher than the required cost and effort of deploying LTE networks, and this is a result of many factors and parameters that are different in 5G NR.
- Deploying 5G NR networks requires a larger number of cells that cover areas that are smaller than these used in LTE.
- Deploying 5G NR networks requires paying a higher level of attention to the terrains of the area and the obstacles within the area, and this is

because the small wavelength that is used in 5G which does not have a good ability of penetration through obstacles.

- Transmitters in 5G perform better when they are mounted on towers with a lower height than the height used in LTE.
- The network performs better when the maximum power limit of cells is less than it is in LTE.
- The 5G network performs better, when the cell edge margin is set to a higher value than it is in LTE and this avoids the Ping-Pong effect.
- The 5G network performs better, when the mechanical down-tilt of antennas is higher than it is in LTE.
- Repeaters are needed in 5G in a wider range than it is in LTE.

## **5.2 Recommendations**

According to the findings of the study, the following recommendations are listed below;

- Transmitters must be mounted on a height of 40m in the case of LTE.
- An antenna of (65deg 17dBi 8Tilt 700/800MHz) should be used in the case of LTE.
- A maximum power of 50dBm must be set to cells used in the case of LTE.
- Enabling carrier aggregation with multiple bands.
- Modifying azimuth angle and mechanical down-tilt of transmitters as needed according to coverage prediction maps.
- Using multiple bands of E-UTRA Band 1 – 20 MHz in the case of LTE.
- Increasing the number of co-scheduled MU-MIMO users to 5 in the case of LTE.
- Transmitters must be mounted on a height of 35m in the case of LTE.
- An antenna of (65deg 18dBi 4Tilt 1900/2100MHz) should be used in the case of LTE.
- Setting frequency band to (n260) within each cell. This band has a reference frequency of 37GHz.

- Setting the carrier to (400 MHz - NR-ARFCN 2019999) which is on the cells table was set to all cells. This carrier is within the n258 band which has a center frequency of 24.25GHz.
- Increasing the Number of Transmission and Reception Antennas led to an enhancement of the results. This value has been increased from 32.
- Increasing the Number of Power Amplifiers (DL) led to an enhancement of the results. This value has been increased from 2.
- Setting the PRACH preamble format in the cell properties list led to an enhancement of the results. This value has been set to 0 which is correspondent to 14.531 km.
- Setting the field of scheduler in the cell properties list led to an enhancement of the results. This value has been set to (Max C/I) instead of (Proportional fair). This scheduling method allocates the resources required by the users to achieve their maximum throughput demands in the order of their PDSCH  $C/(I+N)$  in downlink and of their PUSCH & PUCCH  $C/(I+N)$  in uplink. This means that users who are under good radio conditions will get the resources they require.
- Setting the field of Cell Edge Margin (dB) in the cell properties list led to an enhancement of the results. This value has been set to 3dB instead of 0 dB. This value refers to the maximum difference between the path loss of the second best server and the path loss of the best server to be considered at cell edge. Certain interference management actions are carried out on cell-edge regions, such as ICIC, eICIC, and CoMP.
- Adding repeaters to the blind zones that are noticed from the coverage prediction maps.

### **5.3 Future Research Perspectives**

After conducting this study, it is suggested that the researchers and the specialists of telecommunications engineering do the following;

- Conduct similar studies that deals with different terrains and clutter classes.
- Study other factors that affect the performance of cellular networks.
- Analyze practical experiences of some telecom companies that have upgraded their services to LTE or 5G NR.
- Study the obstacles and difficulties that face telecom companies while deploying LTE or 5G NR network.
- Investigate different scenarios of deploying LTE and 5G NR networks with different conditions.



# **CHAPTER SIX**

# **CONCLUSION**

# CHAPTER SIX

## CONCLUSION

### 6.1 Introduction

The sixth chapter summed up main ideas of the study with a brief explanation of the content of each chapter.

### 6.2 Conclusion

The main goal of this thesis was to present an inclusive vision of planning and optimizing LTE and 5G NR networks. The study aimed to achieve the optimum level of performance and quality of services as much as possible. The location that has been chosen to conduct the study is an area located in the province of Sana'a, Yemen. This area is in the northern part of Sana'a province. It is basically the area where Sana'a Community College is located, and it is expanded to in all directions to cover a larger area surrounding the college. This college is where the researchers of this study have studied for their bachelor degree. This area is currently urban, and can be considered as a sub-urban area in some parts of it.

The first chapter presented the general framework of the study including; the introduction, the motivation, the problem statement, the importance, the scope, the structure and the key terms of the study.

The second chapter presented the literature review and related works. The literature review included; the concept of cellular communications and its aspects, LTE technology and its aspects, 5G NR technology and its aspects and the concept of cellular planning and optimization. Also, it presents an overview of a number of related works.

The third chapter presented the methodology of the study which depended on discussing the specifications of each technology, then it presented the cited requirements and parameters of each technology, then it presented the initial settings and results, and finally it presented the steps of optimization process.

The fourth chapter discussed the results that were gotten after the optimization process, and it compared it with the results that were gotten before the optimization process. Each result was discussed in term of cause and effect style.

The fifth chapter provided a list of findings and a list of practical recommendations that were adopted according to the results of the optimization and simulation process. The second part of the chapter provided a list of suggestions of future works and studies that can help to develop better perspectives of the current topic and other related topics.

The sixth chapter summed up main ideas of the study with a brief explanation of the content of each chapter.

Reaching an optimum level of performance was a long journey that required lots of experiments and patience. Each stage had to be approved by a kind of scientific reference, but at the same time it had to be tested with other options to verify its efficiency.

The study showed that deploying each technology requires a lot of changes in the parameters. What works well with a technology does not work well with the other. Taking terrains and clutter classes of the studied area to an account

is a key method in the process of planning and optimizing networks, and this is what was experienced through this study.

# REFERENCES

# REFERENCES

- Adibi, Sasan (2015). *Mobile Health: A Technology Road Map*. Germany: Springer International Publishing.
- Al-Dulaimi, Anwer. I, Chih-Lin. Wang, Xianbin (2018). *5G Networks: Fundamental Requirements, Enabling Technologies, and Operations Management*. United Kingdom: Wiley.
- Ali, N. A., Taha, A. M., Hassanein, H. S. (2011). *LTE, LTE-Advanced and WiMAX: Towards IMT-Advanced Networks*. Germany: Wiley.
- Asif, S. Z. (2018). *5G Mobile Communications: Concepts and Technologies*. United Kingdom: CRC PressTaylor and Francis Group.
- Bennis, M., Lin, X., Mozaffari, M., Saad, W. (2020). *Wireless Communications and Networking for Unmanned Aerial*
- Bondarenko, O., Ageyev, D., & Mohammed, O. (2019, February). Optimization model for 5G network planning. In *2019 IEEE 15th International Conference on the Experience of Designing and Application of CAD Systems (CADSM)* (pp. 1-4). IEEE.
- Chen, L. (2010). *Coverage Planning and Resource Allocation in Broadband Cellular Access: Optimization Models and Algorithms* (Doctoral dissertation, Linköping University Electronic Press).
- Cox, C. (2012). *An Introduction to LTE: LTE, LTE-Advanced, SAE and 4G Mobile Communications*. United Kingdom: Wiley.
- Dahlman, E.; Stefan, P.; Sköld, J. *5G NR: The Next Generation Wireless Access Technology*; Academic Press: Oxford, UK, 2018.
- Dahlman, E., Parkvall, S., Skold, J. (2013). *4G: LTE/LTE-Advanced for Mobile Broadband*. Netherlands: Elsevier Science.
- Devaki Chandramouli, Rainer Liebhart, Juho Pirskanen (2019). *5G for the Connected World*. United Kingdom: Wiley.
- Ericsson white paper GFMC-19:000148 March 2019.
- Ertugrul Aksoy (2020). *Advances in Array Optimization*. United Kingdom: IntechOpen.
- Farhaoui, Yousef and Moussaid (2019). *Laila Big Data and Smart Digital Environment*. Germany: Springer International Publishing.

- Ferrer, Mas M. (2021). Network Deployment studies in 5G using ATOLL radio planning tool (Master's thesis, Universitat Politècnica de Catalunya).
- Forsk (2016). Atoll 3.3.2 User Manual for Radio Networks. Forsk.
- Galinina, O., Andreev, S., Balandin, S., & Koucheryavy, Y. (Eds.). (2017). Internet of Things, Smart Spaces, and Next Generation Networks and Systems: 17th International Conference, NEW2AN 2017, 10th Conference, ruSMART 2017, Third Workshop NsCC 2017, St. Petersburg, Russia, August 28–30, 2017, Proceedings (Vol. 10531). Springer.
- Gallardo, L. (2019). 5G Networking: Learning 5G Technology Explained for Dummies. (n.p.): Independently Published.
- Ghazzai, H., Yaacoub, E., Alouini, M. S., Dawy, Z., & Abu-Dayya, A. (2015). Optimized LTE cell planning with varying spatial and temporal user densities. *IEEE Transactions on vehicular technology*, 65(3), 1575-1589.
- Ghosh, A., Zhang, J., Andrews, J. G. (2011). *Fundamentals of LTE*. United Kingdom: Prentice Hall.
- Gütter, D., Luntovskyy, A. (2022). *Highly-Distributed Systems: IoT, Robotics, Mobile Apps, Energy Efficiency, Security*. Switzerland: Springer International Publishing.
- Hashimoto, K. (2009). *RF Bulk Acoustic Wave Filters for Communications*. United Kingdom: Artech House.
- Holma, Harri & Toskala, Antti (2012). *LTE Advanced: 3GPP Solution for IMT-Advanced*. Germany: Wiley.
- Imane, Zaame. Mazri, Tomader. Amine, Elrhayour (2020). 5G: Architecture Overview And Deployments Scenarios. *The International Archives of the Photogrammetry, Remote Sensing and Spatial Information Sciences*, Volume XLIV-4/W3-2020, 2020 5th International Conference on Smart City Applications, 7–8 October 2020, Virtual Safranbolu, Turkey (online).
- Jonathan Rodriguez (2015). *Fundamentals of 5G Mobile Networks*. This edition first published 2015© John Wiley & Sons, Ltd.
- Kasch, W. T. M., Andrusenko, J., Everett, J. S., Burbank, J. L. (2013). *Wireless Networking: Understanding Internetworking Challenges*. United States: Wiley.
- Kazi, Emad. Pillai, Rajan. Qureshi, Uzai.r Fakh, Awab (2013). Long Term Evolution (LTE). *IOSR Journal of Electronics and Communication Engineering*

- (IOSR-JECE) e-ISSN: 2278-2834,p- ISSN: 2278-8735. Volume 7, Issue 3 (Sep. - Oct. 2013), PP 36-42 [www.iosrjournals.org](http://www.iosrjournals.org).
- Khan, M. Umar, A. García-Armada, and J. J. Escudero-Garzás. "Service-based network dimensioning for 5G networks assisted by real data." *IEEE Access* 8 (2020): 129193-129212.
  - Krause, A., Anwar, W., Martinez, A. B., Stachorra, D., Fettweis, G., & Franchi, N. (2021, October). Network Planning and Coverage Optimization for Mobile Campus Networks. In *2021 IEEE 4th 5G World Forum (5GWF)* (pp. 305-310). IEEE.
  - Lee, W. C. Y. (2005). *Wireless and Cellular Communications*. United Kingdom: McGraw-Hill Education.
  - Mazzaresse, D., Xiao, W., Jianghua, L., Soong, A. C., Saboorian, T., Lei, W., Yong, W., Classon, B., Yang, Z. (2019). *5G System Design: An End to End Perspective*. Germany: Springer International Publishing.
  - McNally, D., Mayne, A., Bowler, D., Wakefield, T. (2007). *Introduction to Mobile Communications: Technology, Services, Markets*. Ukraine: CRC Press.
  - Mishra, Ajay R (2007). *Advanced Cellular Network Planning and Optimization: 2G/2.5G/3G...Evolution to 4G*. Germany: Wiley.
  - Moray Rumney (2013). *LTE and the Evolution to 4G Wireless: Design and Measurement Challenges*. Netherlands: Wiley.
  - Osseiran, Afif. Monserrat, Jose F. Marsch, Patrick (2016). *5G Mobile and Wireless Communications Technology*. United Kingdom: Cambridge University Press.
  - Pérez-Romero, J., Sallent, O., Ferrús, R., & Agustí, R. (2016, September). Knowledge-based 5G radio access network planning and optimization. In *2016 International Symposium on Wireless Communication Systems (ISWCS)* (pp. 359-365). IEEE.
  - Peter Krüssel *Future Telco: Successful Positioning of Network Operators in the Digital Age*. (2018). Germany: Springer International Publishing.
  - Poole, I. (2006). *Cellular Communications Explained: From Basics to 3G*. Netherlands: Elsevier Science.
  - Prasad, R., Rahman, M. I., Das, S. S. (2010). *Adaptive PHY-MAC Design for Broadband Wireless Systems*. Denmark: River Publishers.



- Ramos, A. R. (2019). Cellular Planning and Optimization for 4G and 5G Mobile Networks (Doctoral dissertation, Universidade da Beira Interior (Portugal)).
- Reed, J. H., Tripathi, N. (2014). Cellular Communications: A Comprehensive and Practical Guide. United States: Wiley.
- Rumney, Moray (2013). LTE and the Evolution to 4G Wireless: Design and Measurement Challenges. Netherlands: Wiley.
- Sauter, M. (2011). From GSM to LTE: An Introduction to Mobile Networks and Mobile Broadband. Germany: Wiley.
- Schober Robert. Wang Li-Chun. Wong Vincent W. S. Ng, Derrick Wing Kwan (2017). Key Technologies for 5G Wireless Systems. India: Cambridge University Press.
- Sesia, S., Toufik, I., Baker, M. (2011). LTE - The UMTS Long Term Evolution: From Theory to Practice. United Kingdom: Wiley.
- Simona Halunga, Octavian Fratu, Nicolae Militaru (2018). Future Access Enablers for Ubiquitous and Intelligent Infrastructures: Third International Conference, FABULOUS 2017, Bucharest, Romania, October 12-14, 2017, Proceedings. Germany: Springer International Publishing.
- Starr, T., Gorshe, S., Galli, S., Raghavan, A. (2014). Broadband Access: Wireline and Wireless - Alternatives for Internet Services. United Kingdom: Wiley.
- Stüber, G. L. (2017). Principles of Mobile Communication. Germany: Springer International Publishing.
- Taylor & Francis (2012). Mobile Communications Handbook, Third Edition. United Kingdom:
- Theo Lynn, John G. Mooney, Brian Lee, Patricia Takako Endo (2020). The Cloud-to-Thing Continuum: Opportunities and Challenges in Cloud, Fog and Edge Computing. Germany: Springer International Publishing.
- Timmers, M., Pollin, S., Van der Perre, L. (2011). Software Defined Radios: From Smart(er) to Cognitive. Netherlands: Springer Netherlands.
- Toskala, Antti. Holma, Harri. Nakamura, Takehiro. (2020). 5G Technology: 3GPP New Radio. United Kingdom: Wiley.
- Tripathi, N., Reed, J. H. (2014). Cellular Communications: A Comprehensive and Practical Guide. United States: Wiley.

- Varrall, G. (2018). 5G and Satellite Spectrum, Standards, and Scale. United Kingdom: Artech House.
- Velrajan, Saravanan (2020). An Introduction to 5G Wireless Networks: Technology, Concepts and Use-Cases.
- Wang, S., & Ran, C. (2016). Rethinking cellular network planning and optimization. IEEE Wireless Communications, 23(2), 118-125.
- Zaki, Y. (2012). Future Mobile Communications: LTE Optimization and Mobile Network Virtualization. Germany: Springer Fachmedien Wiesbaden.
- Zeadally, Sherali. Chaouchi, Hakima. Chilamkurti, Naveen. Next-Generation Wireless Technologies: 4G and Beyond. (2013). Netherlands: Springer London.