

On developing a powertrain in a hybrid car with electricity and compressed-air propulsions

Mohammad Mansouryar

Abstract: A hybrid car with two propulsions of compressed-air and electricity is outlined. To fill up the compressed-air tanks, two methods of electrical and manual air are proposed. The electric propulsion is based on two collections of storing batteries and capacitors. The desired batteries are lithium-ion [1] and the desired capacitors are supercapacitors [2], in which they could store a significant amount of electric energy.

The emphasis in this paper is on the methods of electrically charging the car. A big problem of the present electric vehicles (EVs) is the rather long time to charge them compared to fueling the conventional cars. Also EVs have short range of motion, due to losing the electric energy storage.

Therefore if one would provide the electricity for the EVs for most of the time – not if always – one could drive long distances by them and to have less dependence on the grid for charging them. This would lessen the pressure on electricity, their self-dependence to produce their needed kinetic energy during moving that originates from the environment-polluting power plants. Also it could reduce the dependency on fossil fuels. However, to guarantee the EV to move in the worst conditions, supplying the electricity from the modified grid remains as an option. Four methods of storing the electricity in this EV are: 1) Charging by the modified grid, 2) Charging by the solar cells, interior and exterior of the car, 3) Charging by the bio-force, and 4) Charging by the physical effects.

The type of batteries [(albeit a combination of the oncoming batteries, in the terms of need and case, ought to be verified): 3, 4, 5, 6, 7, 8, 9, 10, 11, 12] and supercapacitors [13, 14] is not the main subject of this paper. Some present models in the car manufacturing industry are assumed proper; more effective and more greenly-made, better.

Introduction: Nowadays, a great problem of environment is the greenhouse effects because of air polluting gases. One important reason of such polluters are cars; therefore if a propulsion system for cars can be presented which is environment-polluter free, that would be

a help to the environment. One such solution is the EVs which run completely on the electricity.

It is assumed that a main problem of the EVs is the long time to charge, that causes consuming a lot of power of a plant. That plant might pollute the environment; also a nearly long charge time creates a higher price for the related owner's power bill.

On the other hand, after passing a given mileage distance that usually is not too long, the EV gets discharged and it needs electricity again. So if the EV needs electric energy, new methods are required that would be a step toward improving the efficiency and strength of the EVs.

In this direction, some methods such as reducing car weight, an aerodynamic-shape and smart driving (start-stop mechanism, coasting (whenever it is possible and right, e.g., while going downhill), and brake to regenerate the power for the battery [15, 16] or otherwise [17]), have already been suggested. Having accepted all these issues [18], this paper attempts to discuss that some further issues would be brought up which we guess could develop comfort and amelioration of the batteries, and charging them too.

In the discussion of comfort and reducing the pressure on the batteries, the basics of the framework is aiding by using a

compressed-air propulsion system, and also the use of supercapacitors to support the battery set. It means the car propulsion is a series-parallel hybrid system [19] similar to that of Toyota Prius [15] where electricity and compressed-air will

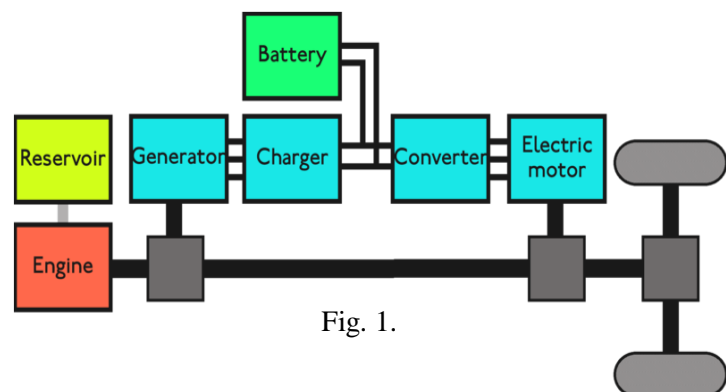

Fig. 1.

propel it (See Fig. 1), but needed electricity can be provided by the batteries and/or supercapacitors whenever required. So one might call this powertrain as a tribid, instead of hybrid. There are four ways of charging:

1) Charging through the (modified) power grid: This is the major current charging method and if other methods would not be available with ease, there would be more dependence on this method. Although it is proposed that a set of vertical axis wind turbine (VAWT), solar panels, and an electrical storing system would be mounted on top of lightning posts, inside

and outside of the cities, in an every other post order; to give the excess of electrically lightening charges to the EVs.

This means that if we exclude half of the present lightning posts from the circuit of the grid, and equip them with a system of renewable electric energy to gain their power, charging of the EVs by these posts will not increase consuming fossil fuels. If needed, any EV could pull over and stop nearby a post – those are almost anywhere having a sign of civilization – and get enough electricity to at least arrive to a nearby main charging place.

The reason of suggesting to approximately half of the posts, is to guarantee producing light – their main purpose for the people – in the worst conditions (i.e., no wind, no sun, no storage, etc). To assess the feedback of such a plan that is not a heavy expense, a short distance between two close cities (for example about 10 kilometers away) can be achieved as an experiment, to observe the consequences of this plan.

Such a plan can be operated in a larger scale, not for half, but for all of the high-voltage transmitting line towers [20]. Getting power from other EVs via a plug-in transfer interface can also be achieved [10] without prevent stealing electricity by thieves. Systems would require two protective layers, first a burglar alarm, and second the driver's approval for the power transfer by pushing his finger on his keychain.

2) Charging by the solar cells, interior and exterior of the car: This method was performed in limited scales before. For instance in an option of the Toyota Prius, one can increase the range of the car up to 15 km in a sunny day, by installing a solar panel on the car roof [21]; at another example of a harsh sun lighting, the hexagonal roof by the help of the smart interior air condition system, does not allow the cabin becomes too warm and unbearable for the passengers [22]. It needs to be mentioned that this method goes far beyond an option in this paper, and it is being considered as an important contribution.

3) Charging by the bio-force: This means using human agents like passengers or even domestic animals. We desire to use the power of passengers' bodies. To that end, a conveyor belt – the same kind of being applied in a treadmill – can be mounted into the car floor to run using electricity storage, and charge some part of the batteries by the force of runner's legs. The belt is connected to a tiny electric motor which by swirling the belt, the shaft of the motor rotates. Thus it generates the electric current; reverse functioning of the heavy-duty, motor-driven treadmills. Clearly, this possibility can be limited to an option for powerful

users in special occasions like camping. Therefore, the range of the produced electricity by this option can be from a short and soft walking (by a man or a pet) for fun, to severe running on it. Otherwise, the user uninstalls the whole treadmill set when he does not intend to apply it. So he reduces the weight of the car. He uses this device when the situation is fit for that.

It would be appropriate to be able to remove this platform that is on the exterior of the car too. Also, it is suggested to give a treadmill to a buyer, when selling as a gift, to be able to give a contribution to charge his car while sporting in his house. Another possibility is to use windup device technology by rotating a handle by hand, or pedaling by foot used for charging batteries or supercapacitors. The order of placing these devices will be explained in further.

4) Charging by the physical effects: This means to apply a physical phenomena to provide the needed electricity of the car. These four methods are: **A)** Electricity is caused by an inductive electromagnetic current due to tossing a rare-earth magnet inside solenoids, **B)** Electricity is caused by the piezoelectric effect due to tensions among the car's structural components, specially in non-pneumatic tires and rings, **C)** Electricity is created by sounds and thermoacoustic effects, and **D)** Electricity is caused by differences in temperatures within the car set, in particular the exterior that suffers from a harsh weather by comparison to the interior with air-conditioning.

Besides, the produced electricity of the shock absorbers will also be considered.

Hybrid Car System Using Electricity-Compressed Air

The proposed car propulsion is a full hybrid [24] that uses electricity [25] and compressed-air [26]. The purpose of choosing the compressed-air propulsion is to decrease the duty cycle of batteries that can be quickly charged in contrast with batteries, and provide a second green system if needed, to minimize having an absolute dependency on electricity to propel the car.

Besides (a part of) excess produced electricity can be used to electrically compress the air in the proper tanks, in which the state of charge (SOC) for the lithium battery set would stay always about humidity of 65% [27] and a pleasant temperature of 5-25 degrees of Celsius for the batteries.

Thus if there is no particular event, whenever the battery storage becomes less than the 65%, the electric propulsion would be deactivated and the compressed-air propulsion system starts acting smoothly and works for a while until new electricity would be obtained for the batteries; and whenever the SOC would be more than 65%, the stored and produced electricity starts compressing the air, instead of charging the batteries.

The goal is to avoid fast charging the batteries as much as possible to let batteries live longer [28]. Also, the battery packs and compressed-air tanks do cooperate with each other to ventilate themselves and provide a proper temperature for both. In particular in the harsh climates, insulating these components is a very important task [29].

Fig. 2.

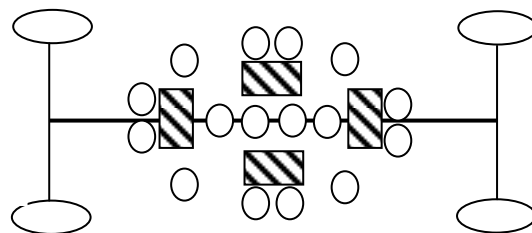

On the other hand, to prevent having a high amount of hotness, the battery pack should be placed at a given distance from each other. See Fig. 2.

The ovals represent tweels, the rectangles represent lithium-ion battery packs, and small circles represent the compressed-air tanks. The overall weight of the batteries must not be more than 200 kg, those are away from the sun-light and lessen the car center of gravity. A prime part of their air-conditioning is through the compressed-air tanks, which have been placed around them.

There is a similar situation for the compressed-air tanks. The schematic design of such a tank can be seen at Fig. 3:

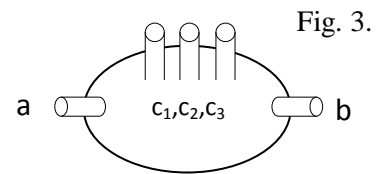

That "a" represents the exit point to the generator to charge the battery. It can also be used for ventilation, but maybe this task would be achieved with another separate exit point. The "b" represents the exit point to the engine cylinders to rotate the crankshaft. The opening and closing these hatches has to be managed by the car central computer and driver's decision. The "c₁,c₂,c₃" are the enter holes of the air, by the foot operated pumps or electric compressors.

Apart from charging the tanks with the compressed-air in gas stations, repair shops and any center having a compressor. Those can be charged by two other ways: electrically or manually. In the electrical way, the excess of SOC of the batteries run one or two tiny compressors connected to every tank to send the compressed-air into the tanks.

In the manual way, one or two foot operated proper pumps, are put at back space of the third row of seats, in which passengers can pump the air tanks by them. This option can be very applicable for the buses. The related hoses connect to the tanks are with two phases; passengers could make a tight connection by their hands between the hose pumps and the first hatch of the tank by swirling, then the second hatch would be opened automatically by the driver's command. That is because the sudden opening of the first hatch, would never lose the air storage of the tanks. For example, if somebody kicks the bung of the first phase by accident, that bung of the second hatch which is under the driver's control, remains untouched in this two-layer protective system. Regarding the fact that the compressed-air is not obtained freely and easily at all, one needs to make sure none of its storage would be wasted.

The idea of several little tanks instead of one or two big tanks, can easily charge them with compressed-air to reach the proper pressure by the passengers and/or compressors; and if the air storage of the tanks would be lost for any reason, the damage would be reduced. All the passengers but driver can do this job.

At least two hoses are required, one is long and can be used outdoors when the car is parked; the other is short and can be used in the interior of the car. Pumping the tanks is similar to pumping a bike tires; i.e., the air-flow can come in, but it cannot come out, except for the propulsion (or ventilation) and through a special hole. So connecting the pump to that, must not cause concerns of discharging the tank. This means if someone does not consider the idea

of pumping the compressed-air tanks by his feet effective, he could not consider it useless neither. In the critical conditions, pumping the tanks can be a gradual procedure to give a contribution to propel the car. It would be little and slow compared to electrical compressors, but we assume it better than doing nothing. This possibility makes this car different from conventional cars which are useless when they run out of fuel.

To reduce the weight and possible danger of bursting, tanks can be made of a proper material, e.g., fiber glass, aerogel, or aluminum. Anyhow, the tanks should not become hot or cold quickly. Like the power source of the center for the supercapacitors management, the adjuster of the second hatch that connects a pump to the tank is one of the few components in this car which has a special small battery to use when none of the other batteries can be used. This should also remind the clock battery of the computers [30]. Albeit if needed, these special small batteries can be charged in conjunction with other batteries.

One can add a further application to fill the tanks: that can aid to make the battery packs (and even other required components such as motors and brakes) warm/cool while doing this action (pumping). Since there is a direct proportion between the pressure and temperature, if entering the air to the pumps, would somehow be in a relation with exiting the air from around the battery packs, which would be desired to cause increasing/decreasing the air pressure around the batteries and would cause the warmness/coldness around them in result. For adjusting the temperature around the batteries and supercapacitors packs, the thermoelectric effect can be applied too, it will be explained later. Although, using an air-cooling system [31] like in other cars [32] for the internal combustion engine, this notion can be used in this case too.

To generalize this idea to the vehicles such as a truck, pickup truck, minibus, and bus, big tanks can be considered. However, instead of mounting one or two big tanks under the body, a number of small tanks should be mounted in every possible point of the car, to be able to charge them separately, easily, and shortly.

The weight of these tanks should not be destructive for the car propulsion. Also their arrangement toward other components should reduce the car center of gravity. If for any reason, the driver chooses a propulsion over the other system, that would be adopted. For example in a rainy weather, or in a hot weather, to protect the batteries until drying/cooling them by the air flow, the compressed-air propulsion may be used for most of the time; or in

altitudes where the air density is rather low, the electric propulsion may be used for most of the time.

Also, whenever it is needed to impose more power to the car, for example to pass an uphill or to come out of a pit, by fuzzy logic of the central computer or driver's decision, two propulsion systems jointly using electricity and compressed-air act in common and the car would suddenly take off [34]. In this situation, all of the cylinders (4-12 numbers as a proposal) would be used to move the crankshaft, or electrically charge the batteries to pump a gross amount of power into the motors. Maybe even the devoted electricity to the air-condition would be appropriated to the propulsion for a few moments. Of course, the length and duration of this operation must be short and bearable to avoid any damage to this EV powertrain. When all the cylinders are active, we expect a lot of strength, and the compressed-air storage finishes fast; but in the usual situation, it might be good to deactivate some cylinders [35] sometimes to use the compressed-air storage with a less strength and slower motion, for a longer duration. In particular if something wrong happens to the batteries and they fail to work, we would have to apply only one system – compressed-air – propulsion. Herein, it is needed to use supercapacitors that give more contributions until being conveyed the car to the nearest repair shop.

If something wrong happens with the cylinders too, the emergency propulsion would be started; as a description, the produced electricity of the solar cells (specially if they are active in the night too [8, 36]), bio-force and physical effects, would not be conducted to the batteries and would get to the motors. Now this can be in two modes: **A**) Directly to the motor: This option is possible, if the amount of electricity is big and monotonous and it causes no technical problem for the motors, i.e, it would not burn the motor, totally or partially; and **B**) Indirectly to motor: It needs a control unit, rather small and light.

The program assumes the harvested electricity would be consumed by motor, after reaching to a specific threshold in definite cycles. For example, after 5 minutes trying the bio-force by pedaling, motors would go to a smooth path for 2 minutes, with the averaged velocity of 20 km/h, and if the gained electricity of physical effects and solar cells are alright, the passengers can rest about 2 minutes, after any 5 minutes of action for the bio-force electricity.

The emergency propulsion can also be used for the recreational and experimental conditions, or even giving a rest to the lithium batteries, supercapacitors, or compressed-air tanks, time to

time. However, when all the tanks, batteries, and cylinders are failed, and there is a long distance to the repairing/charging center, then there is no help from other cars, the passengers can slowly propel the car, instead of waiting or walking in unpleasant weather.

If the road is smooth and sun shines well, strong passengers do pedal. Maybe the car reaches to higher velocities of 40 or 50 km/h. If the weight and dimensions of the emergency propulsion control unit are too large, its kit should be optional and removable. If somebody considers probable to use it, he mounts it easily, otherwise he leaves it at his home.

General Outward Characteristics of the Car

The car should be in the class of a Minivan, SUV, Crossover, or Station wagon. For instance, the cars bodies below are suitable (See Fig. 4); albeit perhaps with some increase in length, width and height of the original platform. We do not insist on our taste, just as examples:



Fig. 4.

The car needs to be grille guarded on front for safety (See Fig. 5), and for extracting the solenoid electricity. To minimize the damage in a crash, hood and back (cargo) booth needs to be in a manner that keeps distance between the impact and passengers.



Fig. 5.



Fig. 6.

Also for safety and saving the interior, spare wheel (if it is necessary at all), would be mounted at outside the rear of the car (See Fig. 6). If not necessary, the rear would be grille guarded similar to the front.

Also, a hatch must be installed on the car roof that can be lifted up manually and/or automatically (See Fig. 7). This reminds one of a similar situation with many bus roofs (it is better to be oval-shaped instead of square-shaped). This must be safe and prevents leaking water and dust from penetrating the inside compartment. Thus, the



Fig. 7.



Fig. 8.

hatch should have a bit taller level (e.g., 1cm), and its rims extend out a little, like a mushroom cap; luckily one can use the experience of a car having exotic doors, or the bus, which have such roofs. In this direction, the skills of such tuners [37] need to be considered (See Fig. 8). Actually the goal is that a person could stand on the treadmill at the middle of cabin and run easily. The

car seats must be as luxurious as an air-plane seat in which passengers could sleep on them comfortably; (See Fig. 9; [38]). Albeit separating by the block as observed, it is not desired and the picture is only to emphasize comfort. Another example is Maybach [39]. Besides, if all want to sleep in the same direction, maybe the third row seats need to enter into a cargo space for several tens of centimeters. There are three rows of interior seats: The first row belongs to the driver and driver's mate, with enough space in middle. The second row consists of two seats, parallel to the first row and confronting to the third row normally, the third row consists of three seats. Also, all of the seats, except the driver's and the middle one of the third row, should be adjustable to rotate easily (See Fig. 10).



Fig. 9.



Buick Business



2008 Dodge Grand Caravan



Fig. 10.

Chrysler Town & Country

If using a treadmill is required, two portions of that simple bench-like middle seat of the third row should be removable, and be sent to the cargo space or somewhere else.

The type of used materials of the car, must be of the best possible components to bring efficiency, comfort and high safety. Also, they have to be environmental-friendly and renewable [40, 41], the applied plastics must be non-oil based [42]. In fact, it would be carbonic fibers [43, 44, 45, 46, 47], carbon Kevlar [45, 46, 48, 49], carbon fibre monocoque [50], polycarbonate [51], aluminum [32, 43, 45, 48, 52, 53], magnesium [52], titanium [46, 47, 54], polished stainless steel [48, 55, 56], natural fiber [57], fiber glass [56], reinforced plastic [58], renewable polyethylene [59], thermoplastic [60], nomex composite [43, 61], aerogel [43], makrolon [62], recycled ultra microfiber PET [63], or inconel [64] to construct the body, chassis, cabin, and other components. However, regarding the high price of these materials, one may use the cheaper and more regular materials such as steel [65] and cast iron [66] that can be accepted in some cases that will be explained later. Applying the Tailor Welded Blank (TWB) technology [67] can be another solution to mix some of the mentioned materials to have both efficiency and a rational price.

In inspiring from the air-cooling systems in other cars [32] and its consequences on the car body, an active grille shutter technology will control incoming air to the battery packs and other components. This has a significant effect on cooling the batteries, safety and efficiency [68]. It must block the flow of freezing air when it is cold, and creates a device to remove heat. Of course, this system should function intelligently, i.e., brings only cold air to that component when it is hot, not warm air to raise temperatures. It should not cause tough freezing, craze, and damage neither. The better design of bumper and spoiler will determine air flow control with more hope to increase cooling motors, brakes, batteries, compressed-air tanks and other components [69].

Bumper and spoilers are suggested to consist of polyurethane gel, that recovers its shape after any impact and reduces transmitting the impact force to a pedestrian [70]. The accordion bumper stickers are assumed useful in mild crashes. Also, the car should be equipped with the inflatable seat belts [71].

The optional Mercedes-Benz AIRSCARF neck-level heating system [72] is a good idea if it causes no drowsiness, it should be realized. The carbon ceramic brakes [73] seem a proper option. The tires must be airless that will be explained later. The color of car should be vivid

to help cool the interior. Hanging the LCD screen players from the interior roof which can be sent into inside the roof [74], may be an option for the buyer; if one can slide them to left and right like a coat-hanger, that would be more appropriate.

According to the taste of market, the car body style can be in the platform of sedan, hatchback [75], coupe [76], sport [77], supersport [78], small concept [79], 2+2 [80], or any other class either.

Notice all the items of "general outward characteristics of the car" which are not in direct relation with the propulsion discussion, can be changed to provide more economic possibilities for the buyers and makers.

Modify the Grid to Charge an Electric Car

The present method for electrically charging an electric car is performed by using the grid during a long time, or by power distribution stations during a (rather) short time, or replacing with new batteries in special centers. If the electricity origin is of a renewable, hydraulic, or nuclear plant, the negative impact on the environment is low. Although, if the source is a plant working by fossil fuels, the negative impact on the

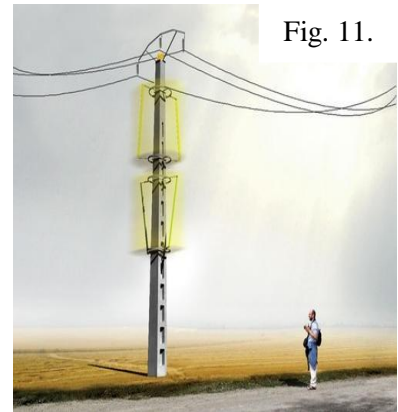

Fig. 11.

environment is high,

Fig. 12.



because the amount of the electricity gained from the grid for an EV, is high. However, the point is, large centers for polluting gas emitters in power plants, can be managed more than using a large number of moving cars that depends upon fossil fuels.

Anyway, our proposal equips light poles to renewable electricity producing systems. The system may use wind and solar means, along with an energy storage system when there is no wind or sun-light.

A wind generator is proposed as the vertical axis type that has a simple structure that captures the wind from all directions.

Vibration (destabilization) on the pole is low, and its outward

harmony with the pole is feasible (See Figs. 11, 12, 13).

Fig. 13.

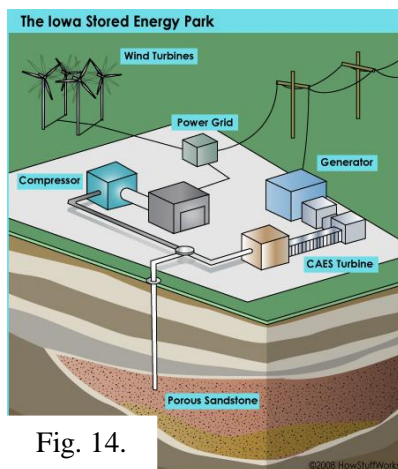

Fig. 14.

Moreover, a small solar panel may use light during the day as a supplement means for the system [81]. Also, a battery that is able to save the lamp electricity for at least 12 hours, causes us to be reasonably ready for the worst conditions. At least one can consider this program with a specific number of poles (e.g.,

every other 2 or 4 or 8 or more), a compressor, attached to a compressed-air storage tank that

would be appropriated to save electricity storage more than the battery. The extra produced electricity would be conducted to the compressor to be saved in the form of compressed-air in the tank to be given to the grid or the required cars; that would be good if one could save the energy in those tanks in the scale of a week. Incoming air to the compressor must be through a special filter to block dust; the compressor can be in a safe steel box on the ground, and the compressed-air tank may be put 1-2 meters under the ground; such a program is being operated in a greater scale for now (See Fig. 14; [82]). We suggest this program be realized locally, rather than nationally. Therefore, every city or country could perform this program in the proper scale, depending on the related economical and other practical conditions.

A division unit can be mounted in a usual height of the pole, which its lid may be opened by inserting a credible credit/ID card, to people with a true need to require electricity that would access the plug and the devices would be away from rain and vandals. If battery had saved lamp electricity for 12 hours, the excess storage would be sent down for the benefit of the EVs. This is the outline of using such poles for the EV owners. They can pull over near a pole, insert a credit card through a slot, the small screen announces this pole needs to be charged for the night. Thus the driver pulls over the next pole and repeats the last actions, this one announces it could charge an EV with some standards with 2kw power for ten minutes, and the price would be 2 USD for example. So the EV could be moved 15 km by this service.

It is predicted the produced electricity in this way is not much, and is considerable only for reaching the car at a proper location for charging. However, apart from reducing the pressure on the national grid by this method, it sounds for the big house-like electric cars (caravans), and motorcycles – in particular for people who want to go to long travels by them – as an interesting possibility. That is because such vehicles could be considered more probable to spend more time near such poles in the roads. It would be more acceptable for the caravans to be parked near such poles; and that also is the case for the motorcycles to be charged more frequently, due to their smaller storage capacity.

To guarantee providing the lightning for the roads, it is suggested that half of the poles would be equipped with this system, and the remaining half would function like before (in an every other one manner). If the government would invest on this project, the costs – especially for the short distances – would not be intense. The security of this program should be established by the government and the people. This means the highway patrols would have a further duty to prevent damaging such pole by vandals. Also appropriating a unique serial number to each

of the devices could be another solution to weaken the probability of stealing them. On the other hand, if the damaging poles rate would grow in an area, the government could decrease the number of such poles in there step by step, so that would be bad for the reputation of that area and less number of EVs would choose passing there, a strike to the local economy. To prevent such a punishment from the government or the related power company, the local residents would protect such renewable devices as their own public wealth, against the looters. Other solutions like aerial patrolling could be done, if the funding gets OK.

If other methods were not sufficient for the car (for any reason), dependence on this method would be very much.

Indeed, car batteries are divided into 4 parts: The #1 part is for obtaining electricity from receiving the main charging centers that include house, road stations, light poles, and shops; the #2 part may involve photovoltaic electricity; the #3 part may use bio-force of the passengers; and the #4 part is for storing electricity from physical motive effects.

If the car is plugged in-to the grid, the #1 part batteries would be charged at first and if time allows, other parts would be charged in turn, because in principle the mentioned part is charged by their own special methods as the first priority. Regarding the technological advancements, it is predicted that the required time for charging the car would be pleasantly short. An ideal picture is a discharged EV would be plugged in to one's house for 5 minutes, then it could be driven for 500 km. This would make such an EV literally perpetual moving. That 5 minutes estimation is for an European user, so the corresponding American user would need 10 minutes!

For instance in the Ref. [83], the battery is charged at 80% within an hour (equivalent to 240 km passing); or in the Ref. [84], charging the Chevy Volt MPV5-2011 five-seater by using 240 volt power, is charged for 3 hours. Therefore, in this car which has two propulsions and the electric propulsion is equipped with 3 additional methods, charging the empty space of the batteries – if it is necessary at all – must last a very short time.

Also, the battery management system does not allow none of the batteries to be charged or uncharged destructively; it alarms the charge near critical limit, and blocks the extra charge. Since lifetime of a lithium-ion battery is limited, we need to such management, or concentrate on the supercapacitors and compressed-air tanks more.

When the car is parked, it needs to take the propulsion to the state of idle control, for the electricity economy [85], and use the start-stop system to be shut down when it is motionless; in the conventional urban cars, this act reduces the fuel consuming about 8 percents [86].

If the car would have a lot of electricity storage, the possibility of using vehicle to vehicle (v2v) should be realized to help a failed car in the roads [10, 23]. Another attractive option can be carrying a light, tiny, easy-mounting (say a 400 Watts model) wind turbine inside the car; if it is supposed to travel to a windy climate location, and when electricity is needed, the car parks in a proper point, turbine would be mounted on its roof quickly, and starts getting charged; this option can be done at the same time of doing other methods, i.e., being charged by a pole, by another EV, by sun, and by the bio-force. Similar to using the treadmill or emergency control unit, this option could be used only when the driver considers it probable. It has to be quite light, less than 40 kg for instance to compensate its weight for the propulsion. We wish further technical advances in the wind turbine field for more efficiency of them for our EV.

Charging by the interior and exterior solar cells

This approach generalizes the present methods for using the solar panels in mass production cars, in reducing the pressure on the batteries, and providing a part of the required electricity for the car. This method imposes numerous changes on the body. This means the outer body of the car doors, roof, and hood need to be removed in the positive & cross body frame, and solar cells that would be inserted under a cover into the removed triangles.

Indeed, using solar panels to help charge the batteries in an electric car is a remarkable idea. These panels cannot be the only source of charging the batteries in a big car, but it is assumed they can be helpful to some extent. Therefore, why not we use them on the outer surface of the car body to absorb sun-light? The answer is safety considerations. How could we protect the passengers in a car with an accident or crash? The solution is to make a balance between the amount of previous materials in the structure of the doors, hood, and roof, which are tight by definition such as carbon fiber, aluminum, or steel, and the amount of solar panels, which are supposed to be inserted within the doors, hood, and roof to absorb sun-light. To that assertion, we need to remove some parts of that component. This action weakens those components against probable crashes, because the solar panels are not as hard as applied materials, say steel, in those components. On the other hand, we need the solar panels for batteries, so what should we use? We should cut the needed components, i.e., doors, hood and roof, but the ultimate result must not considerably reduce the safety of the passengers. How? By inspiring from the earthquake engineering as described in the Ref [91]. See Fig. 15 about the car roof, there are similar plans about the doors and hood:

Fig. 15.

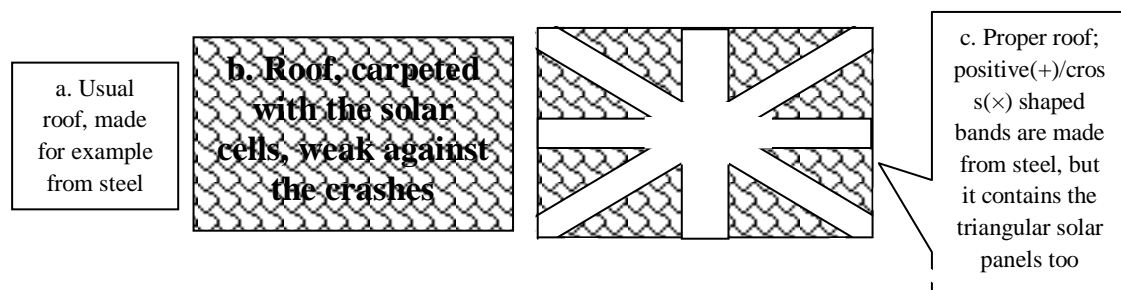

Fortunately, using solar vehicles [21] is a realized concept. Such cars obviously suffer from serious lacks, definitely those are not powerful. However, those could inspire us about the

safety and economic considerations. The spoilers, bumpers, diffusers, fenders, and other components below the doors and hood, remain untouched for this vehicle, because those are vital for the safety in reducing damage from crashes, and these areas do not absorb much sunlight that affect the solar cells. The safety of the doors and hood are used to survive crashes and increase their robustness. The positive and cross shaped structural bands should be bent outward and the bumpers, specially with accordion stickers are also used as the protectors of these covers in the mild crashes.

In other words, integrating the exterior components with the solar panels is limited to three components: doors, hood, and roof. Now, what should be done to trust to these three components in a probable crash? One approach is to consume more material in building material, by making them bent (See Fig. 16):

Fig. 16.

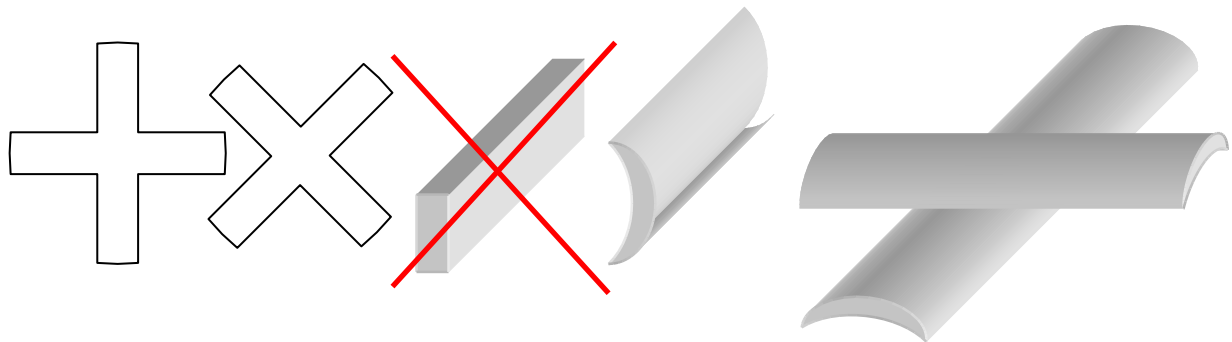

As depicted, bent bands (positive & cross shaped) can better resist in a crash, more than flat bands. They can resist an impact from front or above, better than an unbent band, so they hold the whole structure of the related component (doors, hood, roof). Also they protect the cover over the solar panels by curved regions. This advantage is absent for the case of flat bands, because they would not have an upper level by curvature needed for structural stiffness. On the other hand, the accordion stickers of the bumper would be useful to protect these (very) curvatures of the bands, and also the cover of the solar panels.

Fig. 17.

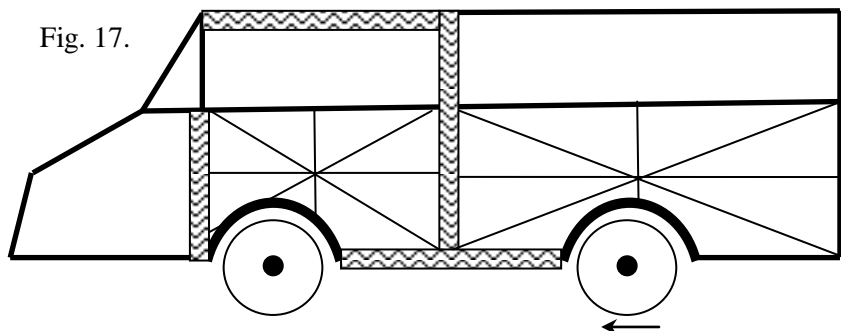

To reduce the crash-from-side impacts, the vehicle compensates by using a protective portion

of the removed sections of the body for solar panels, the fenders and similar components.

These should be peeled off by some centimeters (a bit exaggeratingly, like a Hummer), to have more muscles than other components of the body for a collision (See Fig. 17).

Fig. 18.



The triangular sections (Fig 15c) would be covered by tough and transparent plastic layers, and solar cells are placed under these covers. The type of these covers can be Pyrex or Plexiglas (acrylic glass, see Ref. [87], e.g., application for the bubble over the driver's head in Fig. 18).

For economic reasons, the same type of the guard glass used for car's lamps, are properly united with the basic body material (by soldering, laser welding, etc). In contrast with the automobile Quant [8], the overall cover for all surface areas cannot be perfect. Because if there is slight damage, such as a stone impact, the result will be smeared with color (by an accident, etc) or mud, or similar reasons, that would have a lot of trouble regarding the coverage for the solar cells. However, in using multi-pieces coverage, only a small and removable section would be involved with the damage and the body basic bands reduce the mentioned damage.

By definition, body seams between this transparent cover and basic body would somehow be filled, to prevent water, grime and dirt penetration in the surface and inside the cells. By brazing the aluminum and the help of borax placed into cracks could also improve performance. The current water-conducting edges, i.e., – grooves on the exterior surface of the car bodies that conducts moisture on the downward surface, rain or snow – can be inspired. Perhaps self-cleaning window technology could be applied [88] to help the solar panels under the cover to always receive sun-light. By adding the super hydrophobia property [89] prevent penetrating the surfaces of the roof, hood, and doors would remain wet, but for only a moment. The cover should be transparent and tight to resist in crashes, like the basic body. By the way, it is strongly proposed the solar cells are useful also at night as described in Ref. [36], instead of regular solar cells in the market.

As a suggestion, the first priority of the solar cells is ventilation for components from gases generated by lithium-ion batteries. This means the need for ventilation, would be supplied by each solar cells. However, if the type of batteries would be as in the Mitsubishi iMiEV with no need to further cooling system, because of the used materials [9], there would be less

requirements for ventilation or for the supercapacitors, brakes, motors, and passengers. The extra produced electricity that is not used for ventilation would support the propulsion task.

At the interior of the car, harvesting the solar energy would be achieved in every possible manner. That includes filling up the light lamp bowls (both head & tail) with the solar cells – if there is enough space. Also the flexible solar panels [90] must be shaped like ancient scrolls, without any mechanical complexity and inserted near the handles of the top of windows hanged like a curtain.

When their knots would be untied, they must be tightened by a little vise grip at the end or even loosened at the middle to allow some light rays that would come inside.

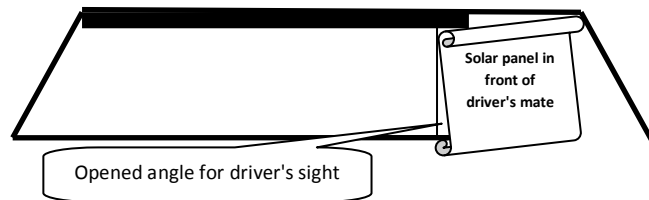

Fig. 19.

The related wires of this panel are inserted in the roof. Albeit, the panel in front of the driver's mate should be away from the window so that the driver could see other cars and things, coming from the right well (See Fig. 19). To clarify, this solar panel placing must not be an obstacle for the driver to see what he needs to see for a perfect driving.

Dark interior space is useful to watch a movie and save the pleasant cold/warm air of the inside (up to the climate conditions) compartment, can be a good idea as well. Except for the driver's front window area, plus a part of the middle area of the rear window that enables a driver to see the back of car (and it can be electro-chromic to help the air-conditioning and gets dark against sun-light, like the roof glass in a Maybach [39]) all of the car windows can be equipped in this fashion.

If the most idealistic status, the whole body can be transparent and have hard material. Maybe we would have a pure appearance of the car that does not have non-transparent separating bands on its body [8]. This is a key to use the solar energy in its most capacity. The pattern of mounting the solar panels on doors, roof, and hood, is inspired by the counter-quake structures [91], (See Fig. 20):

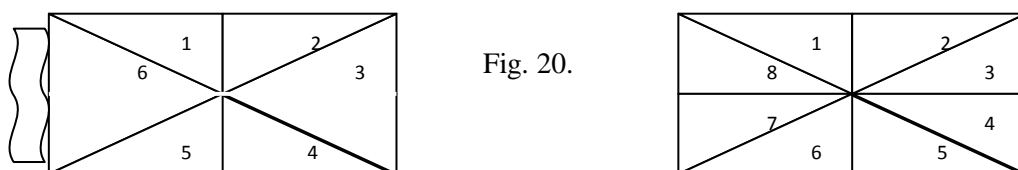

Fig. 20.

The numbered triangles represent the places to insert the solar panels.

The positive and cross shaped geometric bands would prevent falling down the hood and roof, and impact-accepting the body in a crash. Having a grille guard in the front (or even in rear) can make these bands on the hood narrower, or it can remove the longitudinal band on the hood to bring more area for the solar panels. The magnitude of these bands width need to be computed.

All areas of the (front) shelf (i.e., top of dashboard and steering-wheel) can be carpeted by the solar cells, along with a safe glass, Pyrex, or transparent plastic cover. In emergency cases when the ventilation situation of the interior compartment and batteries are OK (according to outside weather, no pressure on them, or any other reason), the solar electricity can be conducted from ventilation to the propulsion for some moments.

There would be a piece of solar panel mounted on the roof hatch to supply the related underneath tiny fan coil unit. Besides, the property of permanent using of solar cells even in night [36], gives this advantage that required ventilation for the components (batteries, motors, etc) and people in the cabin be done, even when the car is not being used, in order to the car be ready 24/7 for serving.

Also, the electric current around the cells and nearby electromagnetic fields must be safe for passengers' health; this concern can be realized by extending out a thin, light layer of aluminum or aerogel (conductive) material around these components, locally or entirely.

Charging Batteries by using Bio-Force

An internal electrical generator that is run by a mainspring, which is wound by a hand crank, and in turn uses a crank to wind the spring [95]. Although inspired by windup devices [92, 93, 94], which provide the needed power for several hours of operation, this method relies on the power of a passenger's hand and feet. The one advantage of encouraging people is that passengers will be active.

The first device is: Reverse mechanism of an electric treadmill, by using a belt on a treadmill mounted in the middle of the car floor. A passenger's feet could walk or run on it, as easy as an actual treadmill. This belt is stretched from under the middle seat of the third row to close the gear for technical reasons. It should not be a regular single-piece, but it should consist of two equal-length pieces, maybe with a bit upward slope, and it is not observable in the usual situation. To use it, two portions of the middle seat of third row need to be removed, and the belt jacks up sufficiently. Hence, the idea is simply installing a manual treadmill, connected to a generator, in the car to use the power of a passenger's (feet) muscles to produce electricity. It is predicted this option would be accepted mostly by the youth, in special occasions like camping. Let me quote from Wikipedia on the treadmill article:

(<http://en.wikipedia.org/wiki/Treadmill>):

"Medical treadmills are class IIb active therapeutic devices and also active devices for diagnosis. With their very powerful (e.g. 3.3 kW = 4.5 HP) electric motor powered drive system treadmills deliver mechanical energy to the human body through the moving running belt of the treadmill. The subject is not changing his horizontal position and is passively moved and forced to catch up with the running belt underneath his feet. The subject can also be fixed in safety harnesses, unweighting systems, various supports or even fixed in and moved with a robotic orthotic system utilizing the treadmill."

"On the running deck the subject is moving, who adapts to the adjustable speed of the belt. The running deck is usually mounted on damping elements, so the running deck has shock absorbing characteristics. By a lifting element, the entire frame including treadmill running deck will be raised and thus simulates a pitch angle for uphill running. Some treadmills also have the reversing of a running belt for the purpose of downhill loads. Most treadmills for

professionals in the fitness area, run for table sizes of about 150 cm long and 50 cm width, a speed range of about 0 ... 20 km/h and slope angle of 0 ... 20%."

"For athletes larger and more stable treadmills are necessary. Sprinters reach with some weight relief temporarily speeds of up to 45 km/h must therefore run on a large deck of up to 300 cm in length and have up to 100 cm width. At high physical exertion and increased risk of falling a fall stop unit is required to prevent a fall of the subjects or patients. This fall stop device is usually implemented by a safety arch on which a rope is attached to an electrical switch. A harness bears the subject preventing from falling and shuts down the running belt."

Therefore, like a wind turbine that runs a generator by the force of wind, this runs a generator by the force of feet (or hands). What point of the car should be mounted? Surely the floor. Albeit, that would be awkward to simply leave it on the floor, so we should take it a bit to a lower level and stretch a layer over the treadmill to cover it. That layer acts like a sliding door and treadmill comes up several centimeters by means of a tiny jack, a means of leverage, or something similar, then it's ready to use!

Thus, one can go stand on it, and starts running. Before this, the roof hatch must be opened to the runner's head could breathe from the exterior air. Two telescopic handles with flexible angle use, come out of the inside volume of the first or second row of seats, to runner could hold them to keep his balance while running like a usual treadmill (See Fig. 21). Although this gesture should not reduce the comfort from other passengers.

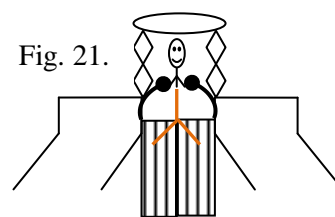

It is desired that the belt and its equipment would be light enough to remove easily if needed, and take them several meters away from the car along with related wire. Then one could run on it outdoors too; in this status, he should be near a wall or a handle-like object to rely his hands on it to keep his balance.

For safety reasons, running on the belt when the car is moving is forbidden. The car treadmill can be ordered in two modes: First, with a removable belt (inspired by the accessory devices in the special cars of the disabled) to take it home, (to put it on a treadmill) and runs on it to produce the electricity. Note this treadmill is an option and buyers could order it at the first place or not.

Second, a complete treadmill for the house can be used to transfer its electricity by a simple surface-mounting wiring to a plug in the ground floor (garage, parking lot, etc) and connect the car to that plug. If a person runs on his treadmill in his house, say in the fourth floor, then he can send the produced electricity to his car. If somebody's house would be in a high location, say the fiftieth floor, instead of direct wiring, the related building should be equipped with a sport saloon (in the first floor), where the person takes his treadmill there, or uses other treadmills to charge his car. In the display screen of the house treadmill, only showing the total percentage of the charged batteries seems enough. Exchanging the information with the car is through the related wire.

To state more clearly, an electric treadmill uses electricity to move human feet, now what if that person's feet consumes energy to give electricity? He can do it at interior of his car as described above, or in a place where is far from his car; the main difference in this situation is several meters of wires to transfer the produced electricity to the car batteries.

Various treadmills are in different sizes (for adults, children, etc) that can be purchased. Also, using domestic animals like dog, horse, cow, or sheep can also be used to this end, by particular treadmills [96]; charging the car for owners of these animals sounds easy, and benefiting from the animals for this job can be done professionally, and finds economic aspects. Beside, the plugs of charging the batteries via running on the treadmill, must be more than one number.



Fig. 22.

Another possibility, is installing rotatable handles, like clockwork radios (See Fig. 22) or on car doors that look like the window regulator crank handle in the old model cars (See Fig. 23). Below all of the windows and near all of the passengers but the middle seat of the third row, such handles would be installed to rotate them for several rounds, and give a contribution to charge the lithium-ion batteries / supercapacitors.

Fig. 23.



Fig. 24. These handles must be hand-friendly, ergonomic, and telescopic (i.e., can be plunged into itself), and may be adjusted in four modes of easy, normal, sportive, and supersportive. Respectively in these modes, the handles can be manually inserted in the proper holes of a disc (dial), and radius of rotation increases to impose more torque and more force would be made (See Fig. 24).

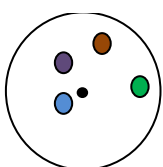

The middle seat of the third row has two special handles, connected under treadmill belt generators. The mentioned handles can be rised sufficiently, without jacking up the belt for running on it. These handles would be inserted below that seat, when there is no intention to use them.

Also, if two passengers at the third row want to sit near the windows and decide to pedal with their hands, they can grab a handle of a door in one of their hands, and grab the special handle of the belt by another hand, and do pedal with both their hands. This action would look like pedaling in the boat races. Clearly, the devices are user-friendly, soft, and adjustable in proportion to the physical sizes of the passenger's body (fat, thin, ...) and person feels an equal pressure on both of his hands. Also that portion of handle which remains in the fist (knob), should be adjustable to come outward (e.g., by pressing a button), it should have the least length, and be very soft to have no damage for side parts of its user in a probable accident. At the first and second row of seats, any person can rotate just one handle, and passengers can replace their positions with each other, if they want to cooperate in producing electricity in this way. In the case of critical need to power, or having spare time, the recreational or strenuous pedaling can be done.

Fig. 25.



Fig. 27.

The radius of the driver's disc (dial) of rotatable handle is a bit more than that of driver's mate, and that of driver's mate is a bit more than that of others', because there are more probability and motivation of using the mentioned handles respectively, and more produced electricity in result.

Fig. 26.



Furthermore, inspired from a radio powered by a pedal-driven generator (See Fig. 25; [95]), or squeezing a handle to spin a flywheel attached to a small dynamo in a mechanically powered flashlight (See Figs. 26, 27; [97]), ten numbers of handles (somehow button-shaped as depicted in

the Fig. 28), which running them reminds one old fashioned

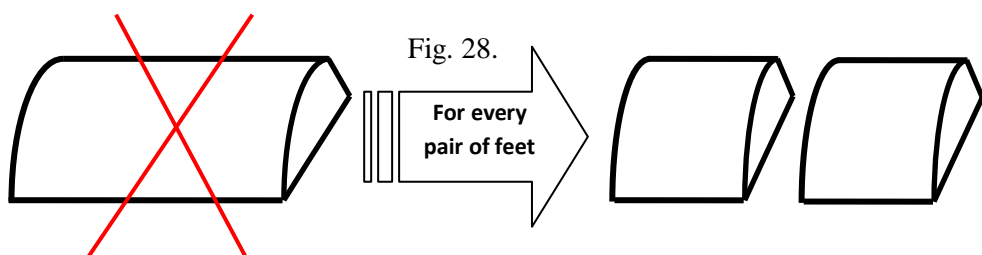

Fig. 28.

sewing machines and threading spindles, would be mounted under the passengers' feet

(every foot, one proper handle), except the driver and middle seat of the third row, in which passengers do charge the car batteries by their feet, if they want to.

Fig. 29.



Keyboard Skin Protector Cover



Fig. 30.

Of course it should be noted the dirt and grime of the

passengers' shoes would not penetrate into the gaps among these handles and car floor; to that end, like a plastic cover for a computer keyboard (See Fig. 29), at least one plastic cover would be put, over the handles to prevent shoe's dust to go beneath, and be shaken outdoors sometimes like the present rubber car floor mats (See Fig. 30), or be cleaned by a tiny vacuum-cleaner that is powered by the car source itself, in order to passengers keep clean under their feet forever. Those who are used to shake their feet for stress releasing, are suitable for this issue. Also, this option can be so applicable for the buses.

It is suggested the car is equipped with a weighing system that measures the entering/exiting weight and announces it by loudspeaker. Therefore, after adding one individual to the passengers, it announces for example 80 kilograms has been added to the total weight, to compensate the would-be-used propulsion electricity for the 10 kilometers distance, 5 minutes of hand-pedaling or 3 minutes of foot-pedaling (or a definite number of pedals) must be performed.

Driver can deactivate or prolong this announcement. This possibility if would be welcomed by people, can lead to more trend from the drivers to pick up the others in their cars, with believing the fact that, it is a good thing to help the environment by the bio-force charging, and also proven effects of sport on the health, and people in return, do aid the car propulsion in compensation of their own and their cargo weights.

This method of charging brings some special ramifications; for example for safety reasons, it would be better there is no infant interior of the car, when there is an intense bio-activity to produce electricity; and driver plus passengers upgrade the security considerations. Also, to more comfort for sporting interior of the car, the adults' safety belt must become loose a bit (maybe except for the case of feet-pedaling), and in the conditions of probable danger, the belts come back to the previous tight state fast.

Moreover, that would be great if people accept for reducing the pressure on the propulsion batteries, it is better to provide the needed electricity of the "*recreational*" devices like playing movie or music, by bio-force (and in the worst situation, by other methods); for instance at bottom of the screen that plays a film, it announces every 30 minutes that the DVD player requires 20 pedals otherwise it will shut down 2 minutes later, in order to watchers do pedal while watching the movie too. On the other hand, the car ventilation must work well to prevent the unpleasant effects of sweat smell around the interior, so the cover seats might apply smart cloth [98] in their fabric. Even more air-conditioning to stop scattering the sweat and bothering others might be needed. Also, an alarm could announce passengers to stop charging by this mechanical method, if needed.

The gained electricity in this method can be consumed to any case, by the driver's decision; for example a part of it can be appropriated to warm up the exterior body surface after snowing, to melt away the snow over the solar covers to enable them to receive the sun light. On the other hand, this method is one of the reasons expressing the fact that this car has plenty of mechanical components, causing new jobs in the automobile industry and related branches.

It should be stated the advancement in the materials engineering is so vital in this subject; an example is the related mainspring (inspired by the windup radio); that would be excellent if one could save a large and long-lived amount of energy by spinning the crank, only a few rounds. Also, it would be proper to make all the charging-by-the-bio-force components removable, to give this possibility for anybody who does not consider probable/suitable of using them, to make him able to drive his car by a lighter weight.

At the end of this section, it is pointed out these ideas can be generalized in a more extended manner, to motorcycles, buses, caravans, etc.

Charging by using physical effects

This approach is a promising and most innovating technological approach. It yields a considerable amount of electricity while driving the car due to physical properties of components. It is not as trivial to charge the grid, as weak as charge the solar cells, and as difficult as charge using the bio-force with passenger muscles. In the most optimistic states, this approach might delete the need to other approaches. Let us review these methods:

A) The electricity caused by Faraday's law of induction, after sliding a rare-earth magnet inside a solenoid.

The notion consists of a mechanism similar to the shake type design of a mechanically-powered flashlight that operates by shaking a hand [99]. Sufficient numbers of solenoids with different geometrical properties can be carpeted on every possible and suitable point of the car,

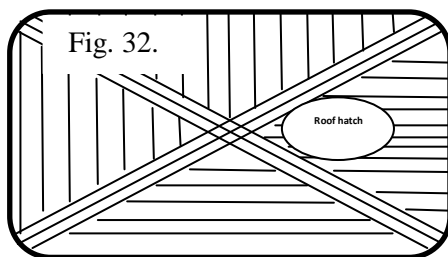

specially the exterior surface of

the body (See Figs. 31, 32). The purpose is: After any change in the

constant velocity of

the car, a rare-earth magnet inside each of the solenoids (See Fig. 33) would move, it produces electricity through electromagnetic induction; the range of production can be released from a few electrons, to the maximum available amount that batteries could require charging.

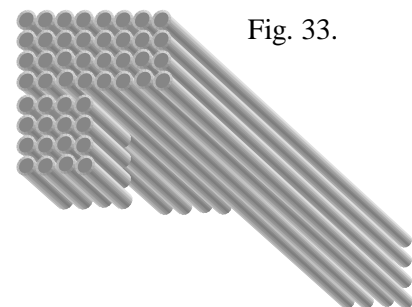
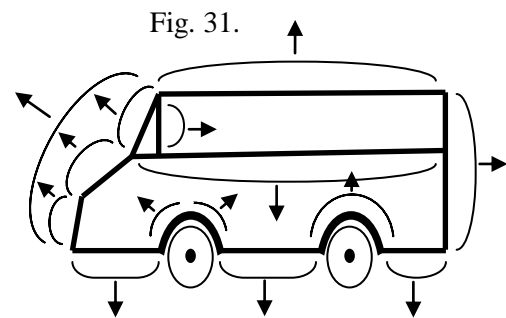

Since this is so vital for this subject, let us quote from the Wikipedia article [99]:

"The linear induction or "shake flashlight" is another design of a mechanically-powered flashlight. It was sold via direct marketing campaigns beginning in 2002. This design contains a linear electrical generator that charges a capacitor when the flashlight is shaken lengthwise. The battery or capacitor powers a high-intensity white LED array. In the linear

generator, a sliding rare earth magnet moves back and forth through a solenoid, and a spool of copper wire. A current is induced in the loops of wire by Faraday's law of induction each time the magnet slides through the spool, which is used to charge the capacitor. Simply shaking the light for about thirty seconds provides about five minutes of light. Shaking the unit for 10 to 15 seconds every 2 or 3 minutes as necessary permits the device to be used continuously. The capacitor is used instead of a rechargeable battery since it doesn't wear out like a battery."

As depicted in Fig. 31, the arches, bows, and curves on the body can be located to provide rare-earth magnets that move inside the solenoids with smooth and continuous motion. If the solenoids are stretched-shaped to some degree, these might be better embedded within the body (See Fig. 34). The ultimate

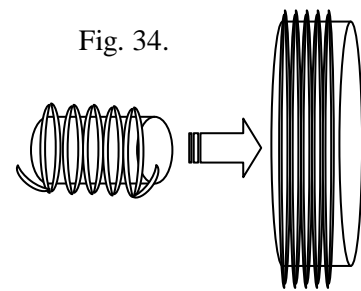

boundary might be similar in this picture: Even a smallest unevenness on the ground (such as gravel or sand) by the vehicle, vibration of other components that includes shaking the car motor, and the smallest pressure change on accelerator or brake pedals can change the car speed – all of these are charging items with motion that is parallel with the current mechanism of using regenerative braking in the motors/generators of electric vehicles – all of this would cooperate to rapidly move the rare-earth magnets inside of the solenoids. Therefore, these agents cause an induction effect in solenoids and each of those solenoids could reach the produced electricity through proper wires to charge the attributed batteries or supercapacitors.

Any component that moves is able to produce electricity by this method. Intelligently altering the suspension system is the key of creating an amount of electricity from the solenoids. For instance, it is effective if there is a movable carbon fiber outer layer of body that contains the solenoids. The relative aluminum (or another conductive material) inner layer of body would be optimized for soothing vibrations while moving the cabin, and passengers' comfort. This can create a balance between an unstable oscillation that experiences magnets inside the solenoids, and a pleasant experience while providing comfortable driving for the passengers. This balance can also cause a mechanical strain amongst the cabin and chassis to produce piezoelectric power. However, the maintenance and stability above these mentioned two layers would be a serious engineering challenge. Adopting a type of sport-tuned suspension might be applied here [100].

In this sensitized mechanism can partially use a duty cycle for fluid and the fluid container of hydraulic hybrid system [101] as an exciting medium.

Fig. 35.

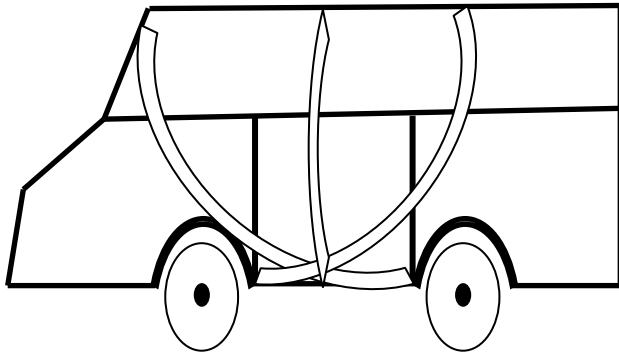

Also, inserting some hard-made solenoids in the exposed suspension portions gives contributions to the vehicle body's robustness; in particular if those are behind the removed sections of the body for mounting the solar panels (See Fig. 35).

Shock absorbers act very strongly and elastically to reach the solenoid electricity to the highest level on rugged and mountainous roads (where fuel consumption in the corresponding ICE

vehicles grows sharply). Besides the car would use the mentioned shock absorbers to provide the passengers' comfort to keep a smooth ride of the seats by a separate suspension system, that isolate the passenger seats from effects due to rough terrain [102]. However, the shock absorbers should shake the car body most of the time [103] to increase the solenoids electricity, with a suspension system equipped with coil springs [104]. Specifically because of the earth's gravitational field, the vertical components play an important role in producing the solenoid electricity. Through installing one (hydraulic-piezoelectric) spring at tails and heads of any piece of a defined solenoid, especially the bottom tail, the rare-earth magnets would experience much tossing, and the springs would also give electricity separately.

To explain the separate role of springs, they could produce electricity in three ways:

1. By traversing a fluid from inside, i.e., hydraulically, like a type of shock absorbers [105];
2. Using a piezoelectric material in or on their structures, i.e., in the core, or on the surface of them; and
3. Similar to the first mentioned approach, passing a fine delicate solenoid from inside them, or at least attaching such a solenoid on their surfaces, see Fig. 36.

Fig. 36.

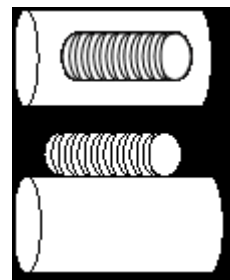

Thus we proceed by charging the batteries. With relying more on supercapacitors in addition to manage the absorption and smart distribution of these diffused electricity productions. To

toss the rare-earth magnets inside the solenoids that are more effective, one should seek ways to increase the velocity and lifetime for oscillating the magnets inside the solenoids. Apart from installing springs as stated above, another solution operates as follows: Both tails and heads of any solenoid can be equipped with a gelatinous object (a plastic, ...) to strongly bounce the rare-earth magnet after contact.

Also, for more vibrations of using a rare-earth magnet inside the solenoid volume, i.e., to move quicker near the mentioned plastics, or plastics to each other, it is proposed that a variable piece inside the solenoid would be composed of (rare-earth) magnetic and plastic parts altogether (See Fig. 37), that resemble the familiar black and white truncated icosahedron pattern of Adidas Telstar-style balls (e.g., white panels denote magnetic parts,

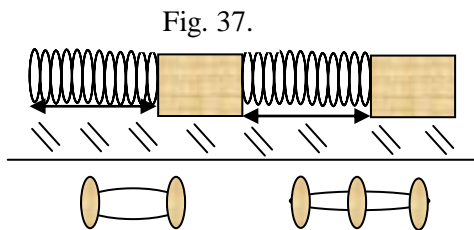

and black panels denote plastic parts, albeit the ball is not hollow). Therefore for the task of vibration, the mixed structure of magnet plus the plastic, would function more effectively than a pure magnet structure.

As another effective means, one can apply active polymer gel actuators [106] that are used instead of plastics in this mixed structure. In fact the active polymer gel actuators would cooperate with the natural momentum caused by road motion, to make further oscillating move for the rare-earth magnets inside the solenoids. The mentioned gels are used locally in the small scales for some tiny electronic devices of the car. By the way, the required starter materials for the reaction by the gels should be provided without using an external source as much as possible, for example we suggest nitrogen must be directly extracted from the air [107].

Having inserted the loops of wire in the spool in the inner layer of solenoid, the plastic levels must be placed higher than the wires. The reason is the intense and longtime movement amongst the rare-earth magnets and inner layer of solenoids will not tear apart the wires, so it should focus on the *outer* layer of the solenoid. By using computer simulations, the geometry of the solenoid volume, the shape and number of plastics, and their elasticity must be specified. It should prevent damage while longtime driving and/or uneven paths. It should use arrangements similar to the high-quality shake type design of mechanically-powered flashlights that are repeated continually in this generalized application; from a single piece of a simple device (flashlight), to plenty of pieces of a complicated device (car).

There is another solution to prevent the impact between rare-earth magnets to the wires inside the solenoid by not tearing up the wires by the magnets by the distance between the magnet and wires. The magnets can be constrained to move within thin and tough rails. This means we must mount too thin and too tough rails inside the solenoids and near the loops of wire where rare-earth magnets would not strike those loops of wire and damage them. Even the magnets could move easier and quickly into the rails. The number and material type of these rails need to be defined by experiments. The electromagnetic induction effects are reduced by the rails that are covered by some side of the loops of wire in the spool.

Efforts to boost the motion of the rare-earth magnets inside the solenoids can be a *sensitive* process. Another way for adjusting sensitivity is by adopting a mechanism, inspired by the linear particle accelerator [108], "a type of particle accelerator that greatly increases the velocity of charged subatomic particles or ions by subjecting the charged particles to a series of oscillating electric potentials along a linear beamline. For particle-to-particle collision investigations, the beam may be directed to a pair of storage rings, with the particles kept within the ring by magnetic fields. As the particle bunch passes through the tube it is unaffected (the tube acts as a Faraday cage), while the frequency of the driving signal and the spacing of the gaps between electrodes are designed so that the maximum voltage differential appears as the particle crosses the gap. This accelerates the particle, placing energy into it in the form of increased velocity. Additional magnetic or electrostatic lens elements may be included to ensure that the beam remains in the center of the pipe and its electrodes" [108].

That could be an effective strategy to mount tiny temporary magnets in tails, heads, and in middle of the solenoids, for this amplifying effect (See Fig. 38). The infinitesimal required electricity to launch these tiny inductive magnets in the path, may be supplied by the car power management unit, sourced by the solar cells or other available methods. A related trick can do so: First specify which solenoids give the most electricity during the computer simulations (normally bigger ones), then little solenoids give automatically their initial produced electricity to such tiny temporary magnets of the bigger

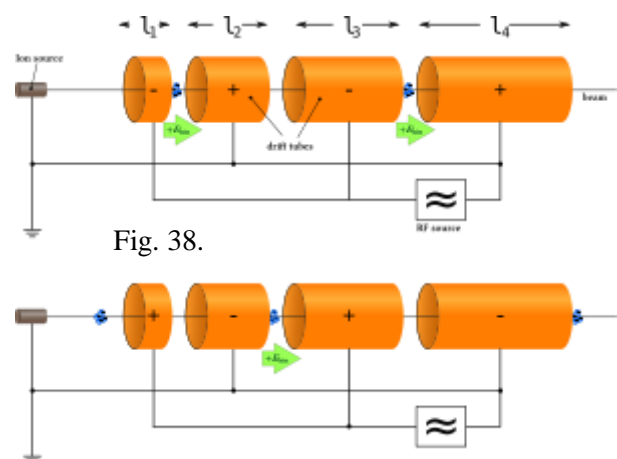

ones at first, then their extra electricity to the batteries /supercapacitors. The weight increase by magnets and solenoids should not be more than 80 kilograms, as the initial estimation.

Obviously all of the attempts should be to extract a significant amount of electricity from the car's solenoids. For example the roof rack that possesses an excellent geometry for solenoid-inserting, trivially should compensate its own weight for the propulsion, and beyond that gives contributions to it. Hence it is suggested the involved metals in producing the solenoid electricity, would have a low density.

The grille guards can also host several solenoids inside of themselves. Furthermore, having numerous solenoids around and inside the body, can account as a kind of guarding, in addition to yielding an advanced structure, those grow up the passengers' safety plus the insurance price for the car body. However, the overall increase of the car weight by these solutions would decrease the damage in the crashes [109], good news for the insurance industry. There are similar considerations with the grille guarding, about the roll cage [110], being used in the racecars for more safety during accidents. Such considerations can be operated if this car makes high speeds, and if the roll cage won't be in contrast with the comfort and health of the passengers (i.e., side-effects of the produced electromagnetic fields, plus the noise of sliding magnets).

Moreover, regarding the high price of the carbon fiber and also aluminum, perhaps increasing the car weight by using steel in the body and chassis will not be a bad idea. For example, increasing the strain among the car components and increasing the piezoelectric electricity in result (See the next method '**B**' on emphasizing the strain between the body and chassis in favor of making piezoelectricity), is a useful feature of increasing the weight by applying steel. Also, a deeper suspension system to keep vibrating the rare-earth magnets and more producing the solenoid electricity as a result is the second useful feature for using steel. Eventually, more affecting the gravity of the increased mass of the car and more regenerating the kinetic energy while changing the constant velocity by accelerator or brake pedals [16, 17] along with a similar effect on the hydraulic hybrid system [101], might be able to relax the destructive effects of the weight increasing on the propulsion.

That could be a good idea to have long solenoids; maybe we can make some of them a bit longer especially those mounted below the floor. If the car radar detector [111] would announce the proper distance with other cars and objects by probing the road, along with the

evenness of the course by scanning the road, maybe the mentioned solenoids can be stretched some inches, automatically, telescopically, and robustly. In these conditions the tails of solenoid would toss more; and thus two agents of further sliding the rare-earth magnet and longer line for traversing it, both may give more electricity. Albeit the safety of not hitting among these stretched tails to anything else, and not becoming fatigued caused by applying the idea must be reckoned.

We intend to obtain a remarkable magnitude of electricity by this way. Thus we must appropriate the obtained electricity to the supercapacitors, which can be charged and discharged fast enough and almost unlimitedly; hence requirement to the battery would be so lessened. This is promising news for the safety and economical aspects. The extra electricity can be allocated to supply the power of turbocharger [112], supercharger [113], and intercooler [32, 114] for the compressed air propulsion forced induction [115], if that would be possible and fit technically, adding more numbers of cylinders for the compressed air propulsion system (up to 12 cylinders), less need to other methods of producing electricity, to even massaging the passengers [116] on the seats! It is predicted this method gives satisfying results on the long bodies of trucks and buses.

B) The electricity caused by the piezoelectric effects due to strain among the components, particularly in wheels and rings.

Fig. 40. By means of using the piezoelectric effect [117], one could make electricity via mechanical strains in the car. Those components that bear much structural pressure, such as carrier ones like ball-bearings [118] and rolling-bearings [119] are deserved to be considered. Another important component in this discussion is a wheel that bares weight and both car and ground press it (See Figs. 39, 40). If one

could insert some piezoelectric strings at the outer layer of airless tire (wheel, also good for solenoids) [120] where is touched by the ground, or at the inner layers of wheel tire to prevent depreciate them, and do connect their tail to a collector, installed in the wheel hub assembly, e.g., by the wireless technology [121] to the closest supercapacitor or battery, it could be created electricity from the strain these strings would experience. Although applying this kind of sending a signal to the car must not cause bad side effects on the passengers' health and sensitive electronic devices as well. Besieging the electricity-using devices by a

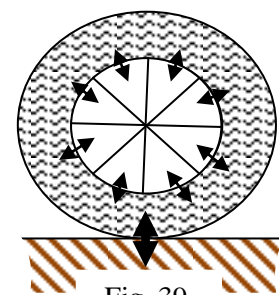
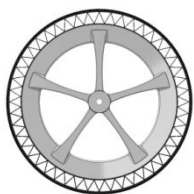

conductive (light, thin, ...) material for distancing between them and the passengers' organs and enclosing the produced electromagnetic fields locally or entirely to save the people's health plus more safety of the devices by this further layer, must also be considered.

On the other hand, one could even apply a further way of making electricity via such wheels, i.e., by a hydraulic mechanism, just like the similar state in the shock absorbers (See Fig. 41; [105]). For example as shown in the Fig. 42, having resembled with a rim trim or a hubcap of 6 double spokes for every single wheel, 4 spokes give hydraulic electricity [105], 4 spokes give

piezoelectricity [117], and the remaining 4 spokes give solenoid electricity. Thus there is a certain guarantee for sliding the rare-earth magnets inside such in-spoke-mounted solenoids! If this item goes alright, it would make one to consider about using a six-wheel powertrain configuration [122] for this car.

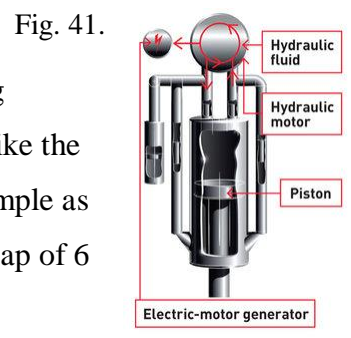

Fig. 41.



Fig. 42.

Although one needs to think about some scenarios to prevent pinning the magnets against one end of the mentioned solenoids for all of the time, due to that intense centrifugal force that magnets would experience during the time of rotating the wheels, that makes this possibility useless. The simplest scenario is to hope that this method is only at low speeds, interestingly at the moment of reducing the velocity it reminds one the regenerative braking contribution to charge batteries. Other scenario is having extremely low-density tiny rare-earth magnets to slide back easily. Another scenario is harshly bouncing them by magnetic repelling, that enables them to overcome the centrifugal force instantly or periodically, e.g., once sliding in every other 20 cycles or every 2 minutes. Next scenario is making stamped plastic spoke-like obstacles for sliding the magnets throughout the solenoid volume to make their sliding slow & problematic, to yield a certain extent electricity before reaching to one end of solenoid while sliding. Using such obstacles can be done automatically just for high speed. Albeit it is predicted this mechanical scenario would be less efficient than the previous magnetic

repelling one, also it erodes the involved spoke-like obstacles. Combining all the said scenarios can be the eventual scenario.

There could be a similar plan for the strain between the rim and the wheel. Additionally, another similar plan can be realized for the valves of the compressed air propulsion cylinders [123] to return a part of electricity devoted to them at least, or inject their own piezoelectricity into the batteries.

The ultimate boundary of this method is to make electricity out of any mechanical strain that exists in the car. That includes from the tension in the suspension system and pressures between the body and chassis (priority of the piezoelectric power from the born strains respectively), tension among the parallel components like the sandwich floor construction, vibrations of other elements after vibrating the motors, to even press the seats by the passengers' [124]. This method must work at least to supply air-conditioning the nearest required zones like warming the seats, steer or mirrors up [125]. Therefore clearly speaking, the strategic idea is applying piezoelectric fibers in all of the stretchable stuffs of the car such as seats covers, mats, steering handle cover, etc. Every defined module would lead to a tiny exit in which the produced piezoelectricity (of moving the passengers' bodies), even the least of them, would be collected in a battery or (super)capacitor gradually. Of course, the economic and hygienic excuses of equipping the small parts of the car interior to this system must be reckoned. It is predicted this method would be more efficient in large vehicles such as truck and bus, because of the greater involved strain among the components.

C) The electricity caused by the noise and thermoacoustic effects.

Having reviewed the possibilities of making noise with the car, one could make electricity out of thermoacoustic effects, even in little amounts [126]. For example the voice of a passenger's talking, sound of playing music, to blow the horn, the sound of braking, the exterior noise (in a traffic, etc), and especially the howl of the air flow, out of the car in high speeds. We propose adopting the sensitization procedure for this method to respect the passengers' comfort.

Moreover, if the sliding magnets would make loud noise, such noise could make electricity; but in this situation the cabin needs to be insulated by anti-acoustic (sound absorber) things like aluminum composite materials (ACM) [127] (their second application: electromagnetic shield), or a layer of polyurethane [128] (its second application: protector of electrical shock)

or mounting the "nylon baffles in various hollow portions of the body structure that are filled with sound-deadening foam, a headliner comprised of five layers of thermal fiber acoustic material, triple-sealed doors with fiberglass "blankets" that act as a barrier to water, airflow and noise, thick laminated windshield and side glass, intake and exhaust systems that are tuned for quiet performance, and 17-inch wheels and tires engineered to enhance quietness and reduce road noise", just like in a Buick Verano 2012 [129]. At last regulating the heads and tails of the solenoids manually or automatically, might reduce the probable noise of the sliding rare-earth magnets. So it should be specified in which conditions the made noise would be louder, long or short solenoid?

The least application of low amount of electricity through this method, can help the nearby device's ventilation, and feeding the initial low electricity required for other mentioned methods – e.g., launching the temporary magnets inside the accelerator-like system inside the solenoids – to provide more power.

D) The electricity caused by the existing "temperatures difference" in the car set, particularly the outdoors having a harsh climate and interior where has been air-conditioned.

If the procedure of "sensitization" would be performed on the related devices, any temperature difference within the car could make electricity. For instance the compressed air tanks and battery packs while increasing temperature in relation with points are at cold temperatures; also outdoor weather which is cold or hot, and interior of the car where it is not, especially in non-moderate regions and after a perfect insulating. What we need is a sensor that receives both absorbed temperature by the body and temperature of the optimized air of interior of the cabin, and makes electricity from this temperature difference [130].

Anyhow, that imposes a maximum degree of insulation, to reduce conducting a part of the charged batteries storage to optimize the proper temperature for their state of charge (SOC) when the car is idle.

The aim is to provide at least a part of required power for ventilation from the temperature difference in nearby. For example the needed electricity for the intercooler [114, 131], or the battery cooling technology [132] or a system that is capable of informing about the temperature of the lithium battery [133] to show it on the car screen display. Indeed all of the information must be shown on the screen in details, including reports of minimum entering to

/ exiting out the electricity of batteries and supercapacitors, after going one meter, even degree of charging because of moving to sun-light after being under a shadow, or e.g., to know that after 5 rounds of spinning a hand-pedal in the third row 4 cells of lithium batteries have become charged. Generally, the concentration in this method is on every two points containing a big temperature difference, and this fact would be detected in simulations and experimental tests.

In fact, more devoting the little scattered harvested electricity for ventilation of the same related region, less devoting the bigger amounts of electricity such as solar and bio-force ones for the ventilation and more devoting them to the propulsion as result.

E) The electricity caused by mounting wind turbines in the channels of the diffuser.

This is a possibility of harvesting the wind energy for charging the car; however, in small amounts. It is so trivial the turbine should not be mounted at the front section of the car, but maybe it would not make trouble at the rear. To this end, one could design a diffuser containing some channels, then to install a stretched VAWT (See Figs. 43, 44)

Fig. 43.



Fig. 44.

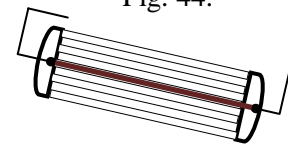

fitted for those channels into all or some of them. The Mercedes-



Fig. 45.

McLaren rear diffuser [134] is a good

inspiration source for this task (See Fig. 45). It is suggested 7 channels would be made in the rear

diffuser, 3 of them located right, left and middle ones that would remain untouched and the proper turbines may be mounted in the remaining 4 other ones. These turbines have to: **1.** Compensate their weights by producing electricity. **2.** Be hard and will not fail because of striking gravels, stones & water drops; For example those can be built by inconel [64] or carbon fiber coated with titanium dioxide [88, 89] and if the car radar detector [111] would announce the coming road improper after scanning, the turbines would come back inside and a sliding hatch covers them. **3.** Have least destructive effect on the propulsion while going in reverse gear.

Outlook: If the solutions in this paper are applied in large and small vehicles, it is hoped there would be some mediation to the environment. Moreover the transportation requirements would also be suitable. This would reduce the fossil fuels to save the world from this mankind's addiction. The emitted carbon and pollution to make any such car could be compensated via planting some trees. In addition, to provide the clean electricity for the related factory and offices where green energy can be used.

If the mechanism that delivers electricity to the supercapacitors would function, and also taking into account the stored energy, the weight of the supercapacitors would be significantly less than the weight of batteries. One can decrease the number of batteries and instead increase the number of supercapacitors. One can even give contribution to provide the electric grid [10, 23].

Acknowledgement: I thank my family and also I specially thank my aunt.

References:

[1] http://en.wikipedia.org/wiki/Lithium_ion_battery ,

[2] http://en.wikipedia.org/wiki/Electric_double-layer_capacitor ,

[3] AGM batteries, low price, no need to maintenance, resist on vibration. It seems more dependence on the supercapacitors, better.

[4] The NiMH battery at BMW Active Hybrid X6; the regenerative braking system for every 25 times of braking restores about 50kw power in the battery. The battery has been contained by a steel protection, after any crash turns off the power to avoid firing. It has a fluid cooling package; even air-condition can be replaced for a separate cooling system that occupies a lot of space and increases the energy either.

[5] The electric sport car Protoscar Lampo2; having two 218 kg lithium batteries container, composed of 216 cells at front and rear and two electric motors giving 300 kw or 408 hp power as overall.

[6] Porsche hybrid 911GT3 R,

[7] Concept Nido EV car from the engineering center Pininfarina. It uses Zebra Z5 Ni-Nad battery, it can pass 140 km distance with 120 km/h velocity when it is fully charged, a green and renewable battery.

[8] http://en.wikipedia.org/wiki/Flow_battery, in particular for the gaps inside the body and cooperative with the supercapacitors; <http://www.nlv-solar.com/quant> & <http://www.nlv-quant.com/> its battery can take this car as long as 500 km, after 20 minutes charging.

[9] The electric car Mitsubishi iMiEV, has a power source as 22 lithium-ion batteries, no need to further cooling system, because of the used materials. It has photovoltaic panels on its roof, reflecting the sun light.

http://en.wikipedia.org/wiki/Mitsubishi_i_MiEV & <http://www.popularmechanics.com/print-this/2011-mitsubishi-i-miev-test-drive?page=all>

[10] The electric car AC Propulsion e Box, has 18650 lithium-ion battery cells, batteries and passengers get cooled together by the air-condition.

<http://www.acpropulsion.com> &
<http://electricandhybridcars.com/index.php/pages/acebox.html>

[11] The car goes about 192 km after any full charging that takes 6 hours, but it goes 72 km after 2 hours charging:

http://en.wikipedia.org/wiki/Coda_Automotive

[12] The ORL technology for a faster charging from the NEC:

<http://www.nec.co.jp/press/en/1011/0503.html> & <http://www.physorg.com/news/2010-11-nec-radical-battery.html> & <http://www.microdiy.com/technologies/flexible-organic-radical-battery-by-nec.html>;

The new generation of the lithium batteries:

http://www.energy-daily.com/reports/World_Most_Powerful_Industrial_Lithium_Ion_Battery_999.html

[13] Honda uses supercapacitors at FCX models; it uses a 100 kw battery, runs the EV up to 450 km. Can we have a similar configuration with say 4 batteries of 40 kw?

[14] The supercapacitors are better than batteries in some features. The EESTOR of Texas announced its innovation is made of barium-titanate and is supposed to be tested in ZENN motor:

<http://en.wikipedia.org/wiki/EESor> ,

Using supercapacitors in the interesting car: BMW X3 EFFICIENTDYNAMICS CONCEPT.

[15] http://en.wikipedia.org/wiki/Toyota_Prius

[16] BMW Active E concept. Regenerative braking increases the efficiency up to 20%.

Toyota Highlander Hybrid imposes regenerative braking for 4 tires, but Toyota Prius does it for 2 tires.

[17] Applying KERS technology at Dezir Concept from Renault. Saving electric and ICE propulsion forces in the flywheel at Porsche RSR 918;

http://en.wikipedia.org/wiki/Kinetic_Energy_Recovery_Systems ,

[18] http://green.wikia.com/wiki/Green_Driving ,

http://www.autotropolis.com/wiki/index.php?title=Helpful_Tips_to_Green_Your_Driving ,

http://en.wikipedia.org/wiki/Fuel_efficiency ,

http://en.wikipedia.org/wiki/Fuel_economy_in_automobiles

[19] http://en.wikipedia.org/wiki/Hybrid_vehicle_drivetrain#Power-split_or_series-parallel_hybrid , (another example): BMW XDrive can conduct 100% of motor power to front or rear tires, due to the conditions.

[20] http://www.inhabitat.com/2009/05/19/metropolis-next-generation-prize-winner-wind-it/wind-it_s/

<http://cleantechnica.com/2009/07/06/new-design-integrates-wind-turbines-into-transmission-towers/>

[21] <http://www.newswire.ca/en/releases/archive/May2007/16/c9889.html> ,

http://en.wikipedia.org/wiki/Solar_vehicle#Practical_applications,

[22] Kia Ray hybrid concept 2010, KMA or the same U.S.A Kia Motors.

- [23] The Vehicle-to-Grid (V2G) technology at AC Propulsion e Box [10];
<http://www.acpropulsion.com/products-v2g.html>
- [24] http://en.wikipedia.org/wiki/Hybrid_vehicle_drivetrain#Full_Hybrids ,
http://en.wikipedia.org/wiki/Hybrid_vehicle_drivetrain#Power-split_or_series-parallel_hybrid ,
- [25] http://en.wikipedia.org/wiki/Electric_car
- [26] http://en.wikipedia.org/wiki/Compressed_air_car
- [27] http://en.wikipedia.org/wiki/State_Of_Health ,
http://en.wikipedia.org/wiki/State_Of_Charge ,
http://en.wikipedia.org/wiki/Battery_balancing ,
- [28] <http://www.hybridcars.com/news/13-key-questions-and-answers-about-nissan-leaf-battery-pack-and-ordering-28007.html> ,
- [29] BMW HL750 highly insulates the hydrogen tank, by the help of aerospace industry; it can be inspired for the compressed-air tanks.
- [30] <http://en.wikipedia.org/wiki/Clock#Purposes> ,
http://en.wikipedia.org/wiki/Real_time_clock , <http://www.physorg.com/news7165.html> ,
- [31] http://en.wikipedia.org/wiki/Air-cooled_engine ,
http://en.wikipedia.org/wiki/Air_cooling
- [32] The concept Jaguar C-X75 (mounting air flow-in channels to the rear electric propulsion); http://en.wikipedia.org/wiki/Volkswagen_Beetle, Volkswagen WOB XL1; Ram Air system at Pontiac GTO; Pontiac Fireboard; concept Pontiac coupe GTO Ram Air 6; Porsche RSR 918; package eagle I Mercedes-Benz S-class tuned by ASMA; Ferrari Italia 458 tuned by Novitec Rosso; intercooler with ice packs in Lamborghini Gallardo LP 560-4 by Under Ground Racing, one could extract the needed water for making ice from the air [33] and by help of solar cells, ice it to cool the batteries. The reverse process can be done for heating.
- [33] <http://www.wired.com/science/discoveries/news/2006/10/71898>
- [34] Subaru Tourer Hybrid Concept, Similar sample of the ICE hybrid,

[35] Chevrolet Camaro 2011, active fuel management turns off 4 cylinders out of 8 ones to reduce the amount of consuming fuel. The Team ULV-3 company has succeeded on deactivating one cylinder of a hybrid propulsion by a software. Deactivating the motor cylinders or variable cylinders management (VCM) in hybrid Honda accord. Pontiac Grand Perry GXP, equipped with the DOD technology of General Motors, sometimes excludes half of the cylinders and includes them back if needed, to reduce the fuel consumption about 12%.

http://en.wikipedia.org/wiki/Variable_displacement ,
http://en.wikipedia.org/wiki/Active_Fuel_Management ,
http://en.wikipedia.org/wiki/Active_Cylinder_Control ,
http://en.wikipedia.org/wiki/Variable_Cylinder_Management ,

[36] <http://www.nrel.gov/news/press/2008/625.html> • <http://www.alt-energy.info/solar-power/new-solar-cells-even-work-at-night> • /
<http://www.smartplanet.com/business/blog/intelligent-energy/scientists-harvest-solar-power-in-the-dark/4150/>

[37] <http://www.zercustoms.com/news/EDAG-Rolls-Royce-Phantom.html> ,
<http://www.carpictures.com/Rolls-Royce/Phantom-by-EDAG-2008-08BCB131426988>

[38] http://www.thaiairways.com.au/thai_inflight_classes.asp?id=8
<http://www.flyinbusinessfirst.com/thai-airways/thai-airways-royal-silk-class-int/>
<http://www.thaiair.com/thai-services/in-the-air/en/royal-silk-class-services.htm>

[39] Most expensive Mercedes-Benz: Maybach 62S;

[40] http://en.wikipedia.org/wiki/Hyundai_Blue-Will ,
<http://www.autoblog.com/2010/01/05/detroit-2010-hyundai-blue-will-phev-concept/>

[41] <http://www.ultimatecarpage.com/car/1940/Suzuki-Landbreeze.html>
<http://www.supercars.net/cars/3210.html> , http://www.toyota.co.jp/en/news/05/1011_1.html
<http://www.hydrogencarsnow.com/toyota-fine-t-x.htm>
<http://www.autoblog.com/2005/10/12/toyota-fine-x-concept-turns-on-a-dime-literally/>

- [42] <http://en.wikipedia.org/wiki/Bioplastic> ,
http://en.wikipedia.org/wiki/Biodegradable_plastic
- [43] <http://www.autoblog.com/2009/08/13/monterey-2009-rizk-auto-aston-martin-dbr2-in-the-carbon/>
- [44] <http://www.supercars.net/cars/3978.html> , <http://www.globalmotors.net/tag/hennessey-performance/>
<http://www.acurazine.com/forums/showthread.php?t=378793>
<http://www.thisweekinmotors.com/hennessey-venom-gt-first-official-images-video-and-details/>
<http://www.autoblog.com/2010/03/29/hennessey-venom-gt-a-600k-mid-engine-cobra-for-the-21st-centur/>
<http://www.insideline.com/lotus/elise/venom-gt-supercar-from-hennessey-performance-engineering.html>
<http://www.team-bhp.com/forum/international-automotive-scene/32181-hennessey-venom-gt-concept-2.html>
- [45] <http://automodifiedesign.com/2011-koenigsegg-agera-r-the-lightweight-hypercar.html>
- [46] <http://motorimpress.com/mercedes-benz/2010-mercedes-benz-e-class-cabrio-carlsson-tuning.html>
<http://www.gtspirit.com/2011/06/15/official-carlsson-tuning-program-for-mercedes-benz-slk-r172/>
<http://www.germancarforum.com/e-class-coupe/34009-tuning-carlsson-improves-mercedes-benz-e-class-cabriolet.html>
- [47] http://www.caranddriver.com/news/car/11q2/2012_audi_r8_gt_spyder-car_news
- [48] <http://www.seriouswheels.com/cars/top-2006-Acabion-GTBO.htm>
- [49] http://en.wikipedia.org/wiki/Ruf_CTR3
- [50] <http://www.leftlanenews.com/mclaren-mp4-12c.html>

http://en.wikipedia.org/wiki/McLaren_Automotive#Hypercar_.28P12.29

[51] http://www.netcarshow.com/porsche/2011-911_gt2_rs/

<http://www.rinspeed.com/pages/cars/zazen/pre-zazen.htm>

[52] http://en.wikipedia.org/wiki/Porsche_964 ,

<http://www.edmunds.com/porsche/911/history.html>

<http://www.corvette-web-central.com/CorvetteC7.html>

<http://www.newcelica.org/forums/showthread.php?p=5368842>

<http://www.ls1gto.com/forums/archive/index.php/t-401705.html>

http://www.netcarshow.com/porsche/2006-911_carrera_4_cabriolet/

<http://www.pistonheads.com/gassing/topic.asp?h=0&f=100&t=806959&mid=0>

http://www.musclecarblog.com/678-2013_chevrolet_corvette_c7_coming_in_2012

<http://www.corvetteblogger.com/2009/08/12/GM-NextGeneration-Corvette-C7-Expected-in-2013/>

<http://www.roadandtrack.com/future-cars/sports-cars-of-the-future-2013-chevrolet-corvette-c7>

<http://www.worldcarfans.com/10507228804/new-porsche-911-carrera-4--4s-cabriolet-in-depth/page2>

<http://autos.aol.com/cars-Porsche-911-2011->

[Carrera_4__2dr_All_wheel_Drive_Cabriolet/expert-review/](http://autos.aol.com/cars-Porsche-911-2011-Carrera_4__2dr_All_wheel_Drive_Cabriolet/expert-review/)

[53] <http://en.wikipedia.org/wiki/Aluminium#Applications>

[54] <http://www.rsportscars.com/gta/2010-gta-spano/>

<http://www.dreamroad.us/spanish-sports-cars-gta-spano-2011/>

<http://www.seriouswheels.com/cars/2010/top-2010-GTA-Spano.htm>

<http://www.salon-auto.ch/en/exposants/tribune/index.php?idContent=21956>

[55] http://en.wikipedia.org/wiki/Audi_TT
<http://www.velocityjournal.com/journal/2011/audi/21990/releases/1533.html>
<http://uk.cars.yahoo.com/car-reviews/car-and-driving/audi-tt-roadster-1005282.html>

[56] <http://unity.lv/en/news/114784/> , <http://www.bbc.co.uk/news/business-11301831>
<http://voteupindia.com/f1-designer-gordon-murray-unveils-lightweight-city-car/>

[57] http://en.wikipedia.org/wiki/Natural_fiber#Industrial_usage ,

[58] <http://www.greencarcongress.com/2008/02/toyota-1x-plug.html>
<http://www.worldcarfans.com/10710103425/toyotas-1x-concept-baby-prius>
<http://inhabitat.com/transportation-tuesday-toyotas-lightweight-1x-concept/>
<http://www.autoblog.com/2007/10/10/tokyo-2007-preview-toyota-1-x-pronounced-1-xth/>
http://www.lltek.com/PRS_bin/PRS_entire_list.htm
<http://www.allfastcars.com/germansupersportscar.html>
http://www.namotorsports.net/detail.cfm/part_cd/DP3C0TS000
<http://www.tuninglinx.com/html/2006-vw-passat-variant-tuning.html>
<http://www.carsession.com/car-news/caractere-volkswagen-golf-6-gti-and-gtd.html>
<http://www.worldcarfans.com/10605087135/porsche-cayenne-clr-400-gt-by-lumma-design>
<http://www.topspeed.com/cars/lumma-design/2006-porsche-cayenne-clr-400-gt-ar7928.html>
<http://www.passatworld.com/forums/109-ami-motorsports/325368-caractere-products-ami.html>

[59] http://en.wikipedia.org/wiki/Renewable_Polyethylene
http://www.yourindustrynews.com/news_item.php?newsID=11408

[60] <http://en.wikipedia.org/wiki/Thermoplastic> , <http://www.supercars.net/cars/4507.html>
<http://www.hrowen.co.uk/lamborghini/new-car-sales/gallardo-lp550-2/>

<http://www.maguscars.com/lamborghini-gallardo-lp-valentino-india.html>

[61] <http://www.newpaltz.edu/news/story.cfm?id=5546> ,
<http://www.popularmechanics.com/cars/news/4309176>

[62] http://www.edag.de/pr/press/pressemeldungen_2009/pm_20_01_2009/en

<http://www.egmcartech.com/2009/01/20/edag-light-car-concept-coming-to-geneva-in-march/>

<http://www.carscomments.com/conceptcars/electric-light-car-open-source-edag-concept-car.html>

[63] <http://www.supercars.net/cars/5144.html> , http://reviews.cnet.com/8301-31166_7-20023300-271.html

[64] <http://en.wikipedia.org/wiki/Inconel> , <http://www.revmods.com/novitec-rosso-ferrari-458-italia/>

<http://www.worldcarfans.com/111022230790/ferrari-458-italia-tuned-by-novitec-rosso>

<http://www.egmcartech.com/2011/02/22/novitec-rosso-ferrari-458-italia-gets-600-hp/>

<http://www.seriouswheels.com/cars/2011/top-2011-Novitec-Rosso-Ferrari-458-Italia.htm>

<http://www.autogeeze.com/2011/03/novitec-rosso-refines-ferrari-458-italia-609-hp.html>

[65] <http://www.zeckhausen.com/BMW/E90.htm> ,

http://en.wikipedia.org/wiki/BMW_3_Series_%28E90%29

<http://www.ultimatecarpage.com/forum/showthread.php?t=33359>

<http://www.autodesigntmagazine.com/articoli/es/146/fioravanti.htm>

[66] http://en.wikipedia.org/wiki/Volkswagen_EA827_engine

<http://www.conceptcarz.com/vehicle/z14903/Mercedes-Benz-S-Class.aspx>

<http://www.dieselstation.com/cars/2009-mercedes-benz-amg-s65-a1354.html>

http://autospeed.com.au/cms/title_Volkswagens-EcoStunner/A_112383/article.html

<http://www.web2carz.com/256/knowledgebase/mercedes-benz-s65-amg/new-generation-mercedes-benz-s-class-adds-v12-models>

- [67] <http://www.i-car.com/pdf/advantage/online/2004/120604.pdf> ,
http://hoyoh.cimne.upc.es/wiki-castelldefels/index.php/Proyecto_SIM-TWB:_soldaduras_con_espesores_diferentes
- [68] <http://www.netcarshow.com/ford/2011-mondeo/> ,
<http://paddocktalk.com/news/html/story-161594.html>
<http://globalproductreviews.com/ford-mondeo-2011-review/>
<http://www.inautonews.com/europe-2011-ford-mondeo-unveiled>
<http://www.talkford.com/topic/152400-active-grille-shutter-system/>
<http://www.autoblog.com/2010/08/27/2011-ford-mondeo-gets-spiffed-up/>
- [69] <http://www.gtspirit.com/category/tuning/fab-design/>
<http://fancytuning.com/2009/12/fab-design-porsche-panamera/>
<http://www.worldcarfans.com/109121423521/fab-design-porsche-panamera>
http://www.tuning-links.com/news_803_Porsche+Panamera+by+Fab+Design+at+Geneva.html
<http://custompinoyrides.com/2011/01/custom-wide-body-porsche-panamera-by-fab-design/>
<http://www.d4u.com.ua/en/manid/44/serid/1060/go/FAB-Design-Porsche-Panamera/tuning.details.html>
- [70] <http://www.revmods.com/carlsson-ck63-rs-based-on-mercedes-benz-sl63-amg/>
<http://www.streetdrift.net/2009/01/carlsson-unveils-ck63-rs-based-on.html>
<http://www.goodgreencars.com/2009/11/2010-ford-flex-to-use-straw-based-plastic/>
<http://www.carpictures.com/Renault/-ZE-Concept-A-Glimpse-into-the-Future-2008-08J1D071812491>
<http://www.worldcarfans.com/109012216449/carlsson-sl-ck63-rs-based-on-facelifted-mercedes-sl-63-amg-details-released>
- [71] <http://automotive-industry-facts.com/Seat-Belts.htm>

<http://boronextrication.com/2010/08/2011-ford-explorer-boron-and-airbags/>

http://www.autopartswarehouse.com/shop_parts/seat_belt/ford/explorer.html

<http://www.vehix.com/blog/car-topics/2011-ford-explorer-first-with-inflatable-rear-seat-belts>

<http://www.worldcarfans.com/109111122998/ford-inflatable-seat-belts-mystery-supplier-uncovered---no-its-not-volvo>

<http://www.carlocate.com/Blog/post/2011/05/03/Rear-Inflatable-Seat-Belts-Guide-Ford-Explorer-to-Major-Safety-Award.aspx>

<http://www.craigslist.com/article/2009/11/10/FREE/911109988/who-helped-ford-with-inflatable-seat-belt-key-safety-systems>

<http://www.thecollegedriver.com/posts/1399-Ford-Explorer-Industry-First-Rear-Inflatable-Seat-Belts-Earn-Prestigious-Safety-Award>

<http://oxmoorautogroup.wordpress.com/2011/05/09/the-2011-ford-explorer-dazzles-from-inside-with-full-slate-of-technical-changes/>

<http://news.consumerreports.org/cars/2009/11/2011-ford-explorer-inflatable-seatbelt-airbags-to-protect-rear-seat-passengers.html>

[72] <http://media.daimler.com/dcmedia/0-921-1258699-1-1277763-1-0-0-0-0-0-11702-854934-0-1-0-0-0-0-0.html>

<http://carsdesigncenter.com/auto/mercedes-benz-slk-class-2012-innovative-system-level-heating-airscarf-neck>

http://www.mercedes-benz.com.qa/content/qatar/mpc/mpc_qatar_website/en/home_mpc/passengercars/home/new_cars/models/slk-class/_r171/facts/around_the_roadster.html

http://www.caranddriver.com/reviews/car/08q3/2009_mercedes-benz_sl63_amg-road_test/gallery/2009_mercedes-benz_sl63_amg_airscarf_neck-level_heating_system_photo_25

[73] <http://www.richliving.co.uk/aston-martin-one-77.html>

<http://www.rsportscars.com/aston-martin/aston-martin-one-77-production-car/>

[74] <http://green.autoblog.com/2008/03/04/geneva-2008-hyundai-hed-5-i-mode-unveiled/>

[75] <http://www.hybridcars.com/vehicle/lexus-ct200h.html>

http://www.businessweek.com/lifestyle/content/dec2010/bw20101228_274304.htm

<http://www.japantoday.com/category/business/view/lexus-launches-hybrid-only-ct-200h>

[76] http://en.wikipedia.org/wiki/Nissan_Skyline , <http://www.7tune.com/2012-nissan-skyline-coupe/>

[77] <http://www.new-cars-model.com/cars/engine/evora-414e-hybrid-based-lotus-elise-hardware>

[78] <http://www.autoblog.com/2009/10/19/veritas-rs-iii-roadster-ready-for-production/>

[79] <http://www.urbee.net/home/>

<http://speed-lines.blogspot.com/2011/04/edison2-very-light-car-with-gas-wind.html>

<http://www.popsci.com/cars/article/2010-11/hybrid-car-created-completely-3d-printing>

[80] http://en.wikipedia.org/wiki/SAAB_9-2

<http://www.roadandtrack.com/auto-shows/geneva/saab-phoenix-concept>

<http://www.cardotcom.com/saab/2011-saab-phoenix-concept/review.aspx>

<http://stylesauto.info/2011/03/17/2012-saab-phoenix-concept-impressive-car/>

[81] <http://www.carbonfreeenergy.cn/9.htm> ,

http://www.vawtmuce.com/Specification_detail.asp?ID=285

http://carbonfreeenergy.en.alibaba.com/product/301034731-200628487/Hybrid_eolic_solar_outdoor_light.html

http://cleantechnica.com/2009/07/06/new-design-integrates-wind-turbines-into-transmission-towers/wind-it_s/

[82] http://www.science.org.au/nova/newscientist/037ns_002.htm

http://news.cnet.com/Saving-wind-power-for-later/2100-11392_3-6170659.html

<http://science.howstuffworks.com/environmental/green-science/iowa-stored-energy-park1.htm>

<http://blog.climateandenergy.org/2010/06/07/compressed-air-energy-storage-the-iowa-story/>

<http://www.allbusiness.com/energy-utilities/utilities-industry-electric-power/11416583-1.html>

[83] <http://www.egmcartech.com/2010/04/19/volkswagen-milano-taxi-concept-an-electric-mpv-taxi-for-major-cities/>

[84] http://www.caranddriver.com/news/car/10q2/chevrolet_volt_mpv5_electric_concept-car_news

[85] <http://www.landrover.com/au/en/rr/about-land-rover/news-overview/2011-range-rover-vogue/>

<http://www.ovalnews.com/2010/06/introducing-the-2011-range-rover-the-most-capable-and-luxurious-suv-in-the-world.html>

[86] <http://www.popularmechanics.com/science/4322287>

http://www.bosch.com.sg/content/language1/html/715_3650.htm

http://www.bosch.co.uk/content/language2/html/3492_5501.htm

<http://www.greencarcongress.com/2008/07/bosch-has-alrea.html>

<http://www.bosch-presse.de/presseforum/details.htm?txtID=3042&locale=en>

<http://www.bosch-press.com/tbwebdb/bosch-usa/en-US/PressText.cfm?nh=00&Search=0&id=301>

[87] <http://www.supercars.net/cars/3235.html> ,

http://en.wikipedia.org/wiki/Lamborghini_Revent%C3%B3n

http://en.wikipedia.org/wiki/Poly%20methyl_methacrylate%20

http://www.greencarcongress.com/2005/09/magna_steyrs_mi.html

<http://www.seriouswheels.com/cars/top-2005-Magna-Steyr-MILA-Concept.htm>

<http://green.autoblog.com/2009/03/03/geneva-2009-magna-steyr-mila-ev-concept/>

http://www.webwombat.com.au/motoring/news_reports/magna-steyr-mila-concept.htm

<http://www.carbodydesign.com/archive/2009/03/23-magna-steyr-mila-ev-design-story/>

[88] <http://wn.com/water-repellant> , http://en.wikipedia.org/wiki/Self-cleaning_glass

<http://www.evonik.cn/sites/dc/Downloadcenter/Evonik/Global/en/Magazines/Evonik-Magazine/Evonik-Magazine-4-2007.pdf>

[89] <http://en.wikipedia.org/wiki/Superhydrophobe> , <http://en.wikipedia.org/wiki/Anti-fog#Application>

http://en.wikipedia.org/wiki/Hydrophobe#Potential_applications

[90] <http://www.suntrica.com/highpower.php> , <http://inhabitat.com/suntricas-wearable-solar-chargers/>

<http://www.popsci.com/environment/article/2010-03/timeline-simpler-sonar>

<http://www.best-solar-energy.com/featured-articles/solar-chargers-for-iphone-ipod/>

<http://www.geek.com/articles/news/suntrica-release-flexible-wearable-solar-chargers-2009057/>

<http://www.greenhoof.com/2010/04/01/timeline-sun-power-gets-easier-with-new-lightweight-panels/>

<http://www.envirogadget.com/solar-powered/suntrica-solarstrap-a-flexible-wearable-solar-panel/>

[91] <http://en.wikipedia.org/wiki/X-bracing> , http://en.wikipedia.org/wiki/Seismic_retrofit

http://en.wikipedia.org/wiki/Earthquake_engineering_structures

http://en.wikipedia.org/wiki/Earthquake_engineering#Earthquake_construction

[92] <http://www.schwinnbikes.com/bikes/electric>

<http://www.gizmag.com/brother-vibration-energy-cell-batteries/15804/>

[93] <http://www.gizmag.com/chukka-tactile-music-player/12476/>

<http://www.techeblog.com/index.php/tech-gadget/regen-the-yo-yo-mp3-player>

<http://www.energyharvestingjournal.com/articles/kinetic-music-player-00001622.asp>

<http://www.mobilemag.com/2006/08/29/regen-concept-puts-an-mp3-player-in-a-yo-yo/>

[94] <http://us.dahon.com/> , <http://us.dahon.com/news/2010/02/biologic-bike-mount-iphone>

<http://www.roadcyclinguk.com/gear-news/biologic-iphone-bike-mount/4923.html>

[95] http://en.wikipedia.org/wiki/Pedal_radio , http://en.wikipedia.org/wiki/Windup_radio

http://en.wikipedia.org/wiki/Batteryless_radio

[96] <http://www.popsci.com/gadgets/article/2010-04/energizer-cow>

<http://inhabitat.com/cows-on-treadmills-could-produce-six-percent-of-the-worlds-power/>

[97] http://en.wikipedia.org/wiki/Mechanically_powered_flashlight

[98] <http://toddygear.com/item.asp?PID=84> , <http://www.touchoforanges.com/mismcl.html>

http://www.macobserver.com/tmo/article/toddy_smart_cloth/

http://trialbyfiremma.com/index.php?option=com_content&view=article&id=200&Itemid=480

[99] http://en.wikipedia.org/wiki/Mechanically-powered_flashlight#Shake_type_design

[100] <http://www.edmunds.com/bmw/m/> , http://en.wikipedia.org/wiki/BMW_M_Roadster

<http://www.tuninglinx.com/html/techart-vario-plus-coilover.html>

<http://www.whatcar.com/car-reviews/bmw/3-series-coupe/summary/25446-4>

<http://www.carsession.com/car-news/carlsson-c25-royale-mercedes-sl65-amg.html>

<http://www.motorator.com/blog/european-cars/techart-coil-over-suspensions-for-porsche>

<http://thecollection.porschedealer.com/new/Porsche/911+GT3+RS/2011/Grey+Black/black/620409/info.php>

http://www.pacificporsche.com/carresearch/Vehicle-Quote/year_2011/make_Porsche/model_911%20Carrera%20Cabriolet/trim_4S/id_21913/confid_pacificporsche/

http://www.ferrari.com/English/GT_Sport%20Cars/CurrentRange/FF/Innovation_Technologies/Pages/FF-Focus_Dynamic_Controls.aspx

<http://www.worldcarfans.com/111012130510/ferrari-four-ff-concept-revealed-video> (...has an independent suspension with magnetically adjustable dampers...)

<http://autotrendcar.com/mercedes-benz/mercedes-benz-c25-royale/carlsson-mercedes-sl-65-amg-c25-royale-an-exotic-luxury-cars-for-young-entrepreneurs.html>

[101] http://en.wikipedia.org/wiki/Hydraulic_hybrid

<http://auto.howstuffworks.com/hydraulic-hybrid.htm>

http://en.wikipedia.org/wiki/Hydraulic_Launch_Assist

<http://green.autoblog.com/2006/06/15/capturing-the-power-of-hydraulics>

<http://www.autoblog.com/2005/12/19/epa-to-save-the-day-with-hydraulics/>

<http://www.autoblog.com/2006/06/26/epa-unveils-hydraulic-hybrid-ups-delivery-truck/>

[102] http://trucks.about.com/cs/concepttrucks/a/toyota_ftx.htm

http://www.toyotaoffroad.com/Articles/Toyota/FTX_Concept/FTX_Concept.htm

<http://www.worldcarfans.com/104032410916/toyota-ftx-pick-up-concept-at-detroit-motor-show>

<http://www.civicforums.com/forums/3-general-automotive-discussion/137321-toyota-ftx-concept-pickup-truck.html>

[103] http://www.mojeepin.com/concept_rescue.html ,

http://en.wikipedia.org/wiki/Porsche_911_GT3

<http://www.jeep4x4center.com/jeep-lift-kits/skyjacker/>

<http://www.topspeed.com/cars/jeep/jeep-rescue-ar1183.html>

http://www.quadratec.com/categories/jeep_lift_kits_suspension/

<http://www.bd-motor.com/products.php?action=view&pid=69&make=26&model=33>

<http://www.eagleday.com/bilstein-pss9-suspension-system-for-porsche-997.html>

http://www.motortrend.com/roadtests/tuners/163_0406_2004_porsche_cayenne_turbo/index.html

<http://www.techart.de/en/techart-showroom/programs/for-cayenne/techart-suv-from-my-08/highlights.html>

<http://www.worldcarfans.com/10608296348/how-mercedes-benz-puts-concept-car-technology-onto-the-road> (<http://www.mbca.org/mbusa-news?page=1>)

[104] <http://www.autoblog.com/gallery/2010-devon-gtx/>

<http://www.autoblog.com/2009/08/15/monterey-2009-2010-devon-gtx/>

<http://www.supercars.net/PitLane?viewThread=y&gID=0&fID=0&tID=175594>

[105] <http://www.wired.com/autopia/2009/02/students-at-the/>

<http://www.popsci.com/scitech/article/2009-05/power-made-shocks>

[106] <http://www.ncbi.nlm.nih.gov/pmc/articles/PMC2820989/>

<http://pubs.rsc.org/en/content/articlelanding/2007/sm/b707393c>

[107] <http://www.ranchcryogenics.com/> , <http://www.ugi.com/cryodist.html>

http://en.wikipedia.org/wiki/Nitrogen_generator ,

<http://www.thescienceforum.com/viewtopic.php?t=18996>

http://en.wikipedia.org/wiki/Nitrogen#Production_and_applications

<http://www.google.com/search?q=nitrogen+extraction+out+of+the+air>

[108] http://en.wikipedia.org/wiki/Particle_accelerator ,

http://en.wikipedia.org/wiki/Linear_particle_accelerator

[109] http://en.wikipedia.org/wiki/Crash_incompatibility

http://www.ornl.gov/info/ornlreview/v41_3_08/article14.shtml

http://www.autotropolis.com/wiki/index.php?title=Buying_Issues:_Efficiency_versus_Safety

[110] http://en.wikipedia.org/wiki/Roll_cage

<http://www.caradvice.com.au/91603/ford-focus-race-car-concept-at-los-angeles-auto-show/>

<http://octanereport.com/new-cars/auto-shows/2010/11/20/2012-ford-focus-st-turbo-race-car-concept-debuts.html>

[111] http://en.wikipedia.org/wiki/Radar_gun , http://en.wikipedia.org/wiki/Radar_detector

[112] <http://en.wikipedia.org/wiki/Turbocharger>

[113] <http://en.wikipedia.org/wiki/Supercharger>

[114] <http://en.wikipedia.org/wiki/Intercooler>

[115] http://en.wikipedia.org/wiki/Forced_induction

[116] <http://www.inada.co.uk/chairs/w1.php> ,
<http://www.backandbodysolutions.com/inada.html>

http://www.c4.citroen.com/lb_LU/in-detail/well-being/massage-seats

<http://www.withoutacar.com/car-news/citroen-c4-engines-thoroughly-finished-688.html>

[117] <http://en.wikipedia.org/wiki/Piezoelectricity> ,
http://en.wikipedia.org/wiki/Piezoelectric_sensor

[118] http://en.wikipedia.org/wiki/Ball_bearing

[119] http://en.wikipedia.org/wiki/Rolling-element_bearing

[120] <http://en.wikipedia.org/wiki/Tweel> , http://en.wikipedia.org/wiki/Airless_tire

<http://www.popsci.com/cars/article/2010-04/future-drive-rapid-response-20>

[121] http://en.wikipedia.org/wiki/Wireless_energy_transfer ,
<http://www.gizmag.com/go/4195/>

<http://www.vervelivingsystems.com/> , <http://en.wikipedia.org/wiki/Fly-by-wire>

<http://www.citroenet.org.uk/passenger-cars/psa/c5/c5bywire.html>

<http://www.thechicecologist.com/2009/07/whole-house-lighting-control-system/>

<http://www.popsi.com/environment/article/2010-01/green-dream-swappable-switches>

<http://www.automobile.com/citroen-develops-drive-by-wire-system-for-mainstream-family-sedan.html>

[122] <http://www.gizmag.com/go/2754/> , http://en.wikipedia.org/wiki/Six-wheel_drive
(This item would be discussed more at future, if the conditions would make it a more economic possibility)

[123] http://en.wikipedia.org/wiki/Hyundai_R_engine

<http://www.bosch.co.za/content/language1/html/3051.htm>

<http://www.theengineer.co.uk/news/perfect-piezo/268707.article>

http://www.dieselworks.co.za/index.php?view=article&catid=4%3Acommon-rail-system&id=5%3Acommon-rail-system-for-passenger-cars-&tmpl=component&print=1&page=&option=com_content&Itemid=6

[124] http://www.nanostring.net/M2E/M2E_Study.pdf ,
<http://www.freepatentsonline.com/7851932.html>

<http://peswiki.com/index.php/Directory:Human-Powered>

<http://drum.lib.umd.edu/bitstream/1903/9083/1/HEAT.pdf>

In this subject, gaining power from both body motions (the produced piezoelectricity) and body heat is a goal. To use the body heat as an electricity source in larger scales, see:
<http://planetark.org/enviro-news/item/59417>

<http://inhabitat.com/body-heat-from-paris-metro-to-heat-residential-building/>

[125] <http://www.supercars.net/cars/5214.html>

<http://mckh.maxforum.org/2011/05/31/2012-dodge-charger-srt8/>

<http://www.tristatenissan-news.com/2011/04/2011-murano-winchester-va/>

<http://www.skimbacolifestyle.com/2011/03/nissan-murano-crosscabriolet-review.html>

[126] <http://www.score.uk.com/research/default.aspx> ,

<http://en.wikipedia.org/wiki/Thermoacoustics>

http://en.wikipedia.org/wiki/Thermoacoustic_hot_air_engine

[127] <http://northclad.com/products/acm/> , <http://www.trade.cn/product/64769.html>

http://www.armetco.com/aluminum_plate.htm ,

http://en.wikipedia.org/wiki/Aluminium_composite_panel

http://www.alcoa.com/aap/north_america/en/product_category.asp?cat_id=1756

[128] <http://www.autoworld.co.za/NewsArticle.aspx?Article=9259>

<http://carceria.com/korando/2011-ssangyong-korando.html>

[129] <http://www.ballasbuickgmc.com/Buick-Verano-Toledo>

<http://www.autos.ca/buick/preview-2012-buick-verano>

<http://www.conceptcarz.com/z19349/Buick-Verano.aspx>

<http://www.insideline.com/buick/verano/2012/2012-buick-verano-2011-detroit-auto-show.html>

[130] http://en.wikipedia.org/wiki/Thermoelectric_effect

http://en.wikipedia.org/wiki/Thermoelectric_generator ,

http://en.wikipedia.org/wiki/Thermoelectric_materials

http://en.wikipedia.org/wiki/Automotive_thermoelectric_generator

[131] <http://www.dieselstation.com/cars/abt-as8-2003-a1175.html>

http://en.wikipedia.org/wiki/Lexus_RX#2009.E2.80.93present

<http://www.lycos.com/info/ford-f-150--ford-f-150-foose-edition.html>

<http://www.roadandtrack.com/tests/impressions/2010-lexus-rx-350-450h>

<http://www.topspeed.com/cars/ford/2008-ford-f-150-foose-edition-ar31065.html>

[132] <http://www.themotorreport.com.au/2818/2008-lexus-ls600hl-released>

[133] <http://www.alliedelec.com/search/productdetail.aspx?SKU=4250030>

<http://www.protoolreviews.com/news/editorials/milwaukee-redlithium-battery>

http://en.wikipedia.org/wiki/Smart_Battery_Data ,

http://en.wikipedia.org/wiki/Battery_management_system

[134] http://en.wikipedia.org/wiki/Diffuser_%28automotive%29

http://www.slr-uk.com/range_overview.php?model=722

<http://www.formula1.com/news/technical/2009/0/621.html>

<http://www.formula1nexus.com/mclarens-and-mercedes-diffusers-ruled-illegal-by-fia/>